

THE EXHIBITORS'™
**HAND
BOOK**
MODULAR DISPLAY SOLUTIONS



ideas
innovation
creativity
communication

VISUAL PRESENTATION SYSTEMS – EXHIBIT & DISPLAY SOLUTIONS



Conference Products
Presentation Medias
Portable Displays
Outdoor Events
Merchandising Systems
Truss & Rigging
Tents & Shelters
Exhibit Structures
Fabric Architectures
Lighting
Literature Racks
Information Centers
Transport Cases
High Quality Graphics

LEADERS IN THREE DIMENSIONAL MARKETING

THE EXHIBITORS'™
**HAND
BOOK**
MODULAR DISPLAY SOLUTIONS

PORTABLE DISPLAYS

2 | BANNER STANDS

RETRACTABLE | TELESCOPIC | SPRING BACK



16 | FORMULATE™ ESSENTIAL BANNER DISPLAYS



18 | VECTOR FRAME™ BANNER DISPLAYS

LIGHT BOXES | BANNERS | KIOSKS



22 | MODULAR BANNER SYSTEMS

CAFÉ BARRIER | AERO



24 | OUTDOOR DISPLAYS

TENTS | FLAGS | SIGNAGE



34 | TABLE THROWS & RUNNERS



SYMBOLS USED:



product made in the USA



economy product



standard product



premium product



product can be recycled
(does not include graphic application)



product comes with a carry bag or case



rental product



new product

PORTABLE DISPLAYS

HOPUP™ TENSION FABRIC DISPLAYS | 38



EMBRACE™ PUSH-FIT FABRIC DISPLAYS | 44



XCLAIM™ FABRIC POPUP DISPLAYS | 48



COYOTE™ POPUP DISPLAY SYSTEMS | 56



FOLDING DISPLAY PANELS | 62



ACCENTS & ACCESSORIES | 66

COUNTERS | LIGHTS | CASES



WARRANTY KEY:



lifetime limited warranty (hardware)



5 year limited warranty (hardware)



1 year limited warranty (hardware)



90 day limited warranty (hardware)



graphics limited 1 year warranty (indoor products)



graphics limited 6 month warranty (outdoor & table throw products)



FABRIC DISPLAYS & STRUCTURES

88 | FORMULATE™ ESSENTIAL

BANNERS | TABLETOP DISPLAYS | 8' DISPLAYS | 10' DISPLAYS



93 | FORMULATE MASTER

TABLETOP DISPLAYS | 10' DISPLAYS | 20' DISPLAYS | ACCENTS



110 | FORMULATE DESIGNER SERIES

10' DISPLAYS | 20' DISPLAYS | 30' DISPLAYS



124 | FORMULATE FUSION 20' X 20' ISLAND KITS



136 | FORMULATE HANGING STRUCTURES



146 | FORMULATE ARCHITECTURAL STRUCTURES

FUNNELS | COLUMNS | TOWERS | ARCHES | CONFERENCE WALLS

SYMBOLS USED:



product made in the USA



economy product



standard product



premium product



product can be recycled
(does not include graphic application)



product comes with a carry bag or case



rental product



new product

MODULAR EXHIBIT SYSTEMS

HYBRID PRO™ MODULAR DISPLAYS | 156

10' DISPLAYS | 20' DISPLAYS | ISLANDS



VECTOR FRAME™ MODULAR DISPLAYS | 168

BANNER DISPLAYS | 10' DISPLAYS | 20' DISPLAYS | ACCENTS



LINEAR™ PRO MODULAR DISPLAYS | 182

10' DISPLAYS | 20' DISPLAYS | ACCENTS



MERCHANDISE EXPRESS™ MODULAR DISPLAYS | 186



ORBITAL EXPRESS™ TRUSS MODULAR DISPLAYS | 190

10' DISPLAYS | 20' DISPLAYS | ISLANDS | ACCENTS

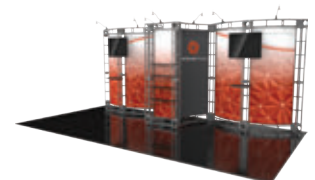

ACCENTS & ACCESSORIES | 214

AERO | COUNTERS | LIGHTS | CASES



WARRANTY KEY:



lifetime limited warranty (hardware)



5 year limited warranty (hardware)



1 year limited warranty (hardware)



90 day limited warranty (hardware)



graphics limited 1 year warranty (indoor products)



graphics limited 6 month warranty (outdoor & table throw products)

PORTABLE DISPLAYS

PORTABLE DISPLAYS

Portable displays are designed for easy use and to prominently represent your brand and message.

They are a means of advertising in retail settings, public places of all types and in face-to-face events such as trade shows, media events, fairs and expositions. Portable displays are **quick and simple** to install.

Portable display types include:

- Banner stands
- Outdoor displays
- Table throws & runners
- Collapsible pop-up style displays
- Folding display panels
- iPad & tablet stands
- Literature racks
- Signs and stands
- Display counters
- Display lighting
- Portable shipping cases

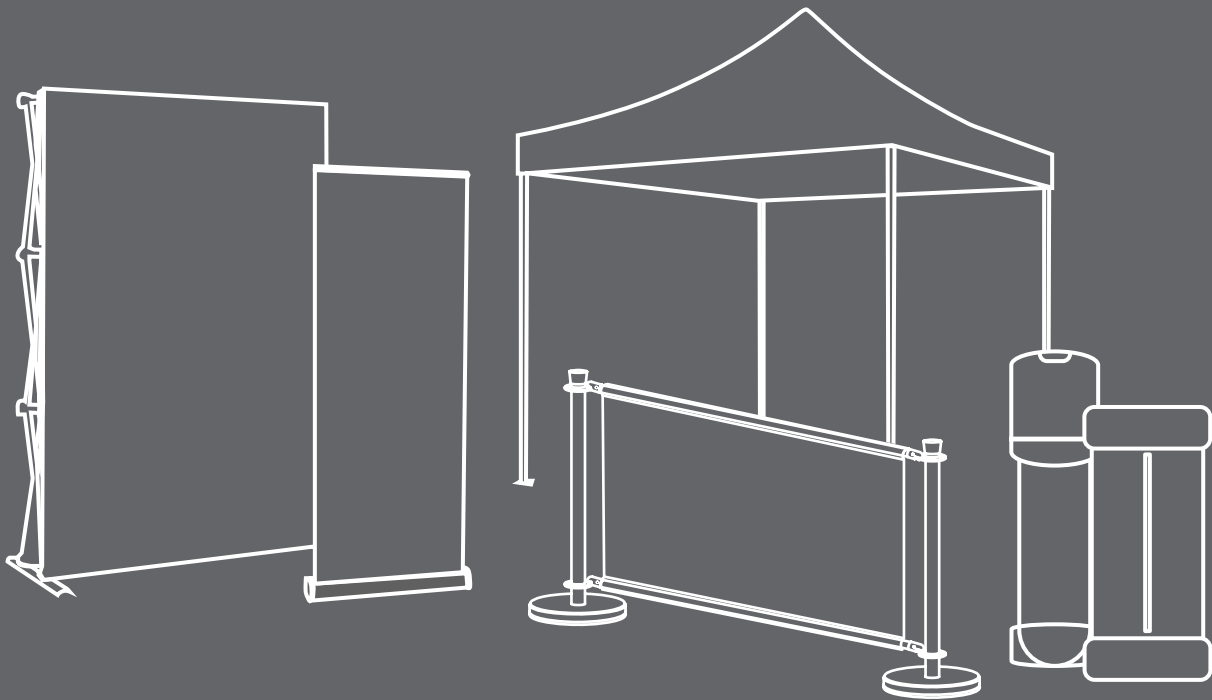

MODULAR SYSTEMS

MODULAR SYSTEMS

FABRIC STRUCTURES

Fabric structures and displays combine state-of-the-art zipper pillowcase dye-sublimated fabric coverings with advanced **lightweight aluminum** tube structures. Fabric structures are used as a means of brand or message advertising in tradeshow and events, as well as in corporate and retail environments as more permanent architectural and interior design elements. Fabric structure exhibit sizes span from tabletop to 10ft and 20ft inline to island sizes.

Fabric structure types include:

- Tradeshow exhibits and related accents & accessories
- Hanging structures
- Funnels
- Towers
- Arches
- Conference walls & dividers

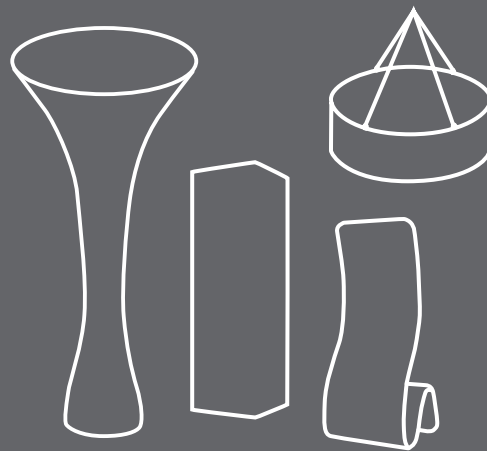

MODULAR EXHIBITS

Modular displays combine a variety of graphic mediums (such as push-fit fabric and mural panel graphics) with aluminum extrusion or steel truss frames. Modular exhibits sophisticated in design and structure and are often **customizable and reconfigurable**. Modular exhibits maximize the lifecycle of a tradeshow display system. Modular display sizes span from tabletop to 10ft and 20ft inline to island sizes.

Modular display systems include:

- Backwalls & banners
- Light boxes
- Exhibit kits
- Kiosks
- Counters





FAST.CLEAR.COMMUNICATION. **BANNER STANDS**

Largest selection of banner stand choices and options • Premium, mid-range and economy stands • Retractable, Telescopic and Spring Back options • Great quality • High-end functionality, features and durability • Specifically designed with unique styling points, giving an exceptional appearance • Multiple accessory and light options



BLADE LITE

23.5" WIDE	BLD-LT-600-1	39.25" WIDE	BLD-LT-1000-1
31.5" WIDE	BLD-LT-800-1	47.25" WIDE	BLD-LT-1200-1
33.5" WIDE	BLD-LT-850-1	59" WIDE	BLD-LT-1500-1
36" WIDE	BLD-LT-920-1		

- variable graphic height = 60" - 83.25"
- seven widths to choose from: 23.5", 31.5", 33.5", 36", 39.25", 47.25", 59"
- toolless quick rail combines the ease of a snap rail with the reassurance of an adhesive fixing
- weighted base for stability
- adjustable leveling feet
- hybrid bungee/telescopic pole







New hybrid bungee/telescopic pole!



PREMIUM RETRACTABLE BANNER STANDS



Premium Retractable banner stands provide superior, high-end functionality, features and durability, as well as unique styling points for exceptional appearance. Premium banners include a protective, molded carry bag and feature a lifetime hardware warranty.

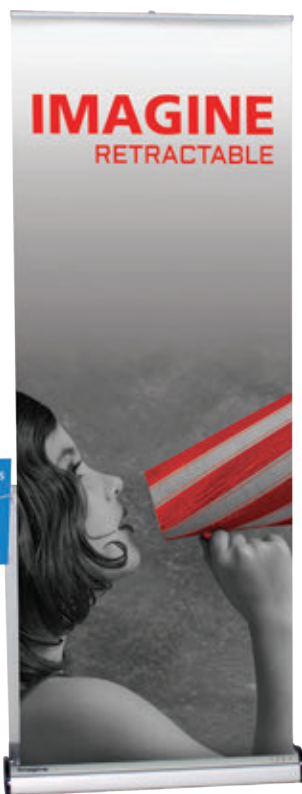

IMAGINE

31.5" WIDE IMG-800-S

- variable graphic height = 29.5" - 83.35"
- graphic tensioner
- integrated pole storage
- interchangeable graphic cassette
- adjustable feet on base
- telescopic pole
- shown with optional literature pocket accessory (AKIT-1L)



BARRACUDA

NEW
Design

31.5" WIDE BCD-800-S-1

35.5" WIDE BCD-920-S-1

- variable graphic height = 60" - 83"
- anodized silver base
- toolless quick rail combines the ease of a snap rail with the reassurance of an adhesive fixing
- graphic tensioner
- adjustable feet on base
- hybrid bungee/telescopic pole
- shown with optional literature pocket and tabletop (AKIT-1S1L)

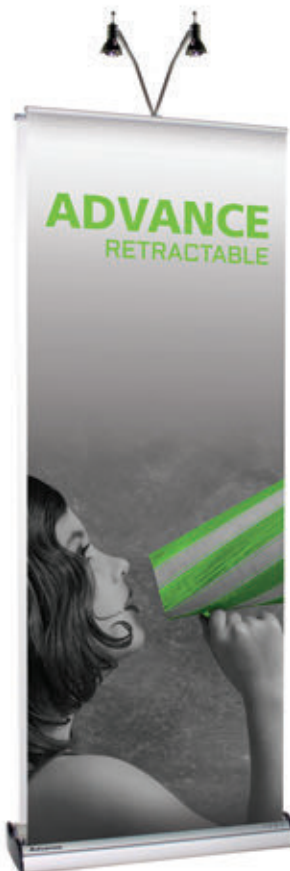

ADVANCE

31.5" WIDE ADV-800-S

- variable graphic height = 29.5" - 83.35"
- double sided
- graphic tensioner
- integrated pole storage
- interchangeable graphic cassette
- adjustable feet on base
- telescopic pole
- shown with optional light Lumina 2 (LUM-2-1)



EXCALIBUR

NEW
Design

31.5" WIDE EXC-800-S-1

35.5" WIDE EXC-920-S-1

- variable graphic height = 60" - 83"
- double sided
- anodized silver base
- toolless quick rail combines the ease of a snap rail with the reassurance of an adhesive fixing
- graphic tensioner
- adjustable feet on base
- hybrid bungee/telescopic pole
- shown with optional tabletop accessory (AKIT-1S)

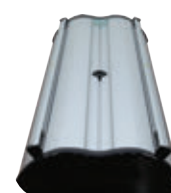



PREMIUM RETRACTABLE BANNER STAND ACCESSORIES

Premium Banner Stand Accessories add style and functionality to any premium stand, single or double sided. Shelf and literature pockets instantly turn select premium stands into a robust display solution by adding tabletop real estate for business cards, small products and a literature pocket to hold brochures.



OPTIONAL PREMIUM BANNER STAND ACCESSORIES

kit 01 includes shelf & lit pocket: AKIT-1S1L

kit 02 includes shelf: AKIT-1S

kit 03 includes lit pocket: AKIT-1L

- works with single and double sided premium stands
- extrusion uprights fit into channel on stand base and lock in place easily
- shelf offered in black laminate; holds up to 5 lbs.
- wire literature rack holds up to 5 lbs. of literature, 8.5" w x 11" h in size



STANDARD RETRACTABLE BANNER STANDS



Standard Retractable banner stands incorporate customary features designed to provide everyday reliability, durability and ease of use. Standard banners include a mid-range canvas carry bag and typically feature a five-year to lifetime hardware warranty.

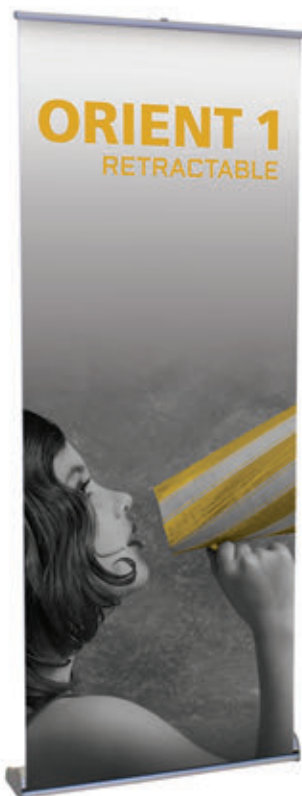

- ORIENT 1** NEW
Design
- 31.5" WIDE** silver: ONT-800-S-4
black: ONT-800-B-4
 - 33.5" WIDE** silver: ONT-850-S-4
black: ONT-850-B-4
 - 35.5" WIDE** silver: ONT-920-S-4
black: ONT-920-B-4
 - 39.25" WIDE** silver: ONT-1000-S-4
black: ONT-1000-B-4

- variable graphic height = 60.5" - 83.25"
- anodized silver or black base options
- toolless quick rail combines the ease of a snap rail with the reassurance of an adhesive fixing
- molded end caps
- adjustable feet on base
- hybrid bungee/telescopic pole



- ORIENT 2** NEW
Design
- 31.5" WIDE** ONT-800-DBL-S-4
 - 35.5" WIDE** ONT-920-DBL-S-4

- variable graphic height = 60.5" - 83.25"
- double sided
- anodized silver base
- toolless quick rail combines the ease of a snap rail with the reassurance of an adhesive fixing
- molded end caps
- adjustable feet on base
- hybrid bungee/telescopic pole



- PACIFIC**
- 31.5" WIDE** PAC-800-S-2
 - 35.5" WIDE** PAC-920-S-2
 - 39.25" WIDE** PAC-1000-S-2

- standard graphic height = 83.75"
- anodized silver base
- molded end caps
- swivel-out foot
- 3-piece bungee pole



- CONTENDER**
- 23.5" WIDE** silver: CN-24-S
black: CN-24-B
 - 29.5" WIDE** silver: CN-30-S
black: CN-30-B
 - 35.5" WIDE** silver: CN-36-S
black: CN-36-B
 - 47.5" WIDE** black: CN-48-B

- standard graphic height = 77.5"
- swivel-out foot
- silver or black base options
- laser cut steel ends & 3-piece pole





STANDARD RETRACTABLE BANNER STANDS

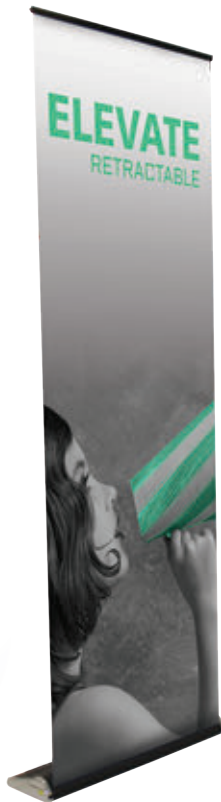

ELEVATE

33.25" WIDE ELEVATE

- variable graphic height = 30.75" - 95.25"
- roller access via flip-top lid and removable graphic roller
- black aluminum body with chrome end caps
- telescopic pole

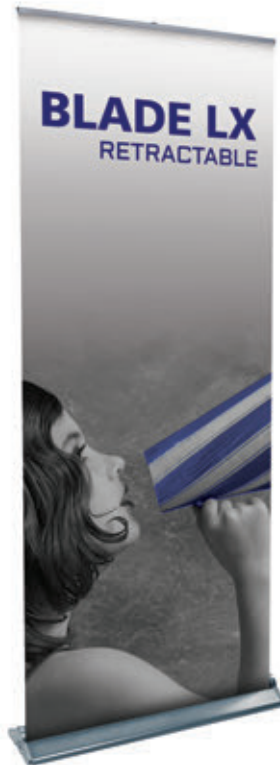
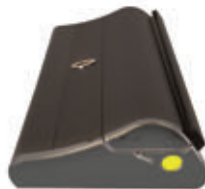

BLADE LX

33.5" WIDE BLD-LX-GRY

- standard graphic height = 83.25"
- anodized gunmetal base
- removable graphic roller
- adjustable feet on base
- premium top rail
- 3-piece bungee pole

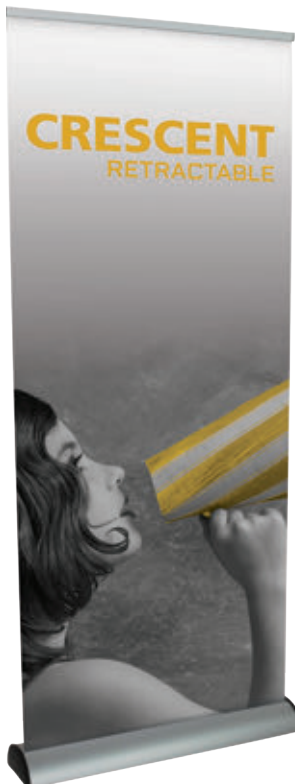

CRESCENT

33.25" WIDE CRESCENT

- standard graphic height = 78.25"
- snap top graphic rail
- silver base with black end caps
- 3-piece bungee pole



BLOK

33.5" WIDE BLOK-850

- standard graphic height = 79.25"
- snap top graphic rail
- black base with chrome end caps
- 3-piece bungee pole



ECONOMY RETRACTABLE BANNER STANDS



Economy Retractable banner stands incorporate basic design features, functionality and reliability. Economy banners include a basic carry bag and feature a 90-day hardware warranty.



START

31.25" WIDE STRT-800-C

- standard graphic height = 79.25"
- snap top graphic rail
- swivel feet
- anodized silver base
- chrome end caps
- 3-piece bungee pole



FREEDOM

31.5" WIDE FRDM-800-C

- standard graphic height = 79.25"
- snap top graphic rail
- chrome end caps
- 3-piece bungee pole



DRAGON FLY

33.25" WIDE DRAGON FLY

- standard graphic height = 78.25"
- double sided
- snap top graphic rail
- swivel feet
- 3-piece bungee pole



SOLO

31.25" WIDE SOLO-800

35.5" WIDE SOLO-920

- standard graphic height = 79"
- snap top graphic rail
- swivel foot
- 3-piece bungee pole





ECONOMY RETRACTABLE BANNER STANDS

MOSQUITO

31.5" WIDE silver: MSQT-800
black: MSQT-800-B

47.25" WIDE silver: MSQT-1200

59" WIDE silver: MSQT-1500

- standard graphic height = 78.5"
- anodized silver or black base options (800mm only)
- swivel feet & snap top graphic rail
- 800mm unit is supplied with one bungee pole per unit, 1200mm and 1500mm come with two bungee poles per unit

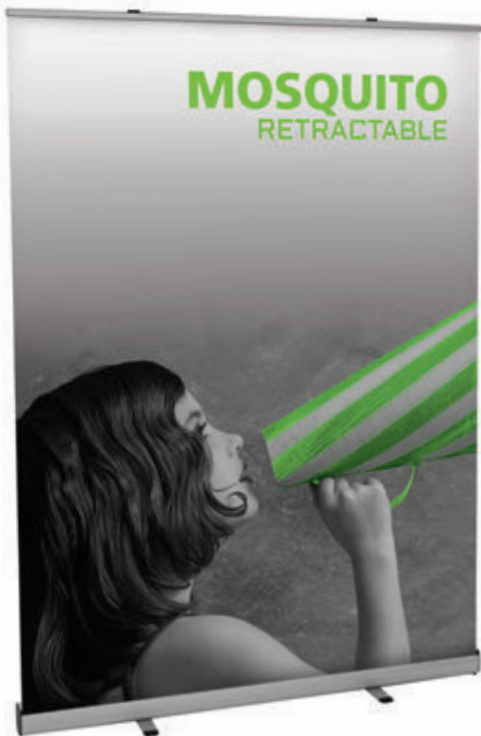

MSQT-1500

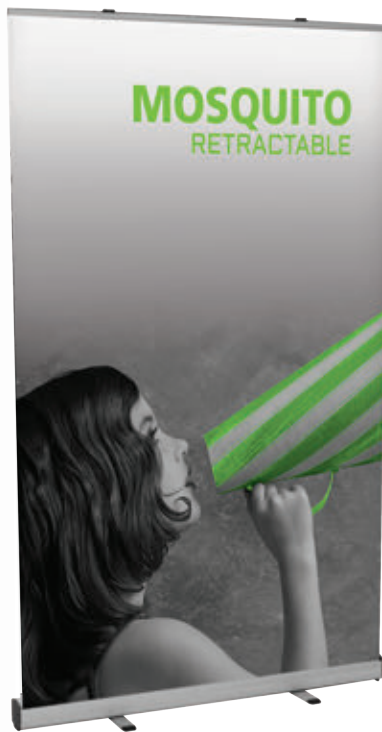

MSQT-1200



MSQT-800

GIANT MOSQUITO

36" WIDE MSQT-GIANT-920-S

- variable graphic height = 68" - 122"
- over 10' tall
- anodized silver base
- swivel feet
- snap top graphic rail
- adjustable telescopic pole
- heavy duty, weighted stand

shown at maximum height



MOSQUITO LITE

31.5" WIDE MSQT-LT-800

- standard graphic height = 78.5"
- anodized silver base
- swivel foot
- snap top graphic rail
- 3-piece bungee pole



ECONOMY RETRACTABLE BANNER STANDS



Economy Retractable banner stands incorporate basic design features, functionality and reliability. Economy banners include a basic carry bag and feature a 90-day hardware warranty.

QUICKSTAND

31.5" WIDE silver: QWK-STND-S

- standard graphic height = 78.5"
- anodized silver or black base options
- kit includes 1 Mosquito 800 banner stand, 1 OCB banner stand case, and 1 Lumina 5 banner stand light
- swivel feet
- snap top graphic rail
- 3-piece bungee pole



OCB case can be seen on p. 79

QUICKWALL

31.5" WIDE silver: QWK-S

- standard graphic height = 78.5"
- approx. overall width = 97"
- anodized silver or black base options
- kit includes 3 Mosquito 800 banner stands and 1 OCB banner stand case
- swivel feet
- snap top graphic rails
- 3-piece bungee pole



OCB case can be seen on p. 79



ECONOMY RETRACTABLE BANNER STANDS



PHOENIX

33.5" WIDE PHX-850-S

- standard graphic height = 79" h
- anodized silver base
- swivel feet
- snap top graphic rail
- 3-piece bungee pole



MERLIN

33.5" WIDE MRLN-850

- variable graphic height = 61.5" - 88"
- anodized silver base
- snap top graphic rail
- hybrid bungee/telescopic pole
- interchangeable plastic cassette



MINI & TABLETOP BANNER STANDS

PHOENIX MINI

15.5" WIDE PHX-400-S

- two graphic height options = 16.5" or 63" h
- anodized silver base
- 2-piece pole & optional 2 extenders for added height
- comes complete with carry bag
- tabletop or skinny full-height banner stand

BREEZE

8.38" WIDE BREZ-1-S:
8.38" w x 11.75" h

11" WIDE BREZ-2-S:
11" w x 17" h

- retractable tabletop banner stand
- ideal for promotional use



stretch table throw can be seen on p. 36

EXPOSÉ TELESCOPIC BANNER STANDS



Standard Telescopic banner stands incorporate customary features designed to provide everyday reliability, durability and ease of use. Standard banners include a mid-range canvas carry bag and typically feature a one-year hardware warranty.



EXPOSÉ

94.5" WIDE EXP-SS-S

94.5" WIDE EXP-DS-S

94.5" WIDE EXP-SS-C

- variable graphic height = 33" - 85"
- straight and curved options available
- straight offered with front graphic and optional back graphic
- flat, low profile bases
- easy assembly



Top and bottom clamps hold rails in place



Telescopic poles for adjustable height



STANDARD TELESCOPIC BANNER STANDS



PEGASUS SUPREME

63.5" - 117.5" WIDE silver: PGSUS3-S
black: PGSUS3-B

- Supreme variable graphic height = 82.75" - 119"
- single or double sided graphics
- linking connectors attach multiple units together
- telescopic poles for adjustable graphic width and height

PEGASUS LINKING KIT

Supreme silver: PGSUS3-EXT-S
Supreme black: PGSUS3-EXT-B
Standard silver: PGSUS2-EXT-S
Standard black: PGSUS2-EXT-B

- linking connectors attach multiple Pegasus units together
- extension kit includes 2 horizontal poles, 1 vertical pole, pole locks, 2 linking connectors & 1 foot



PEGASUS STANDARD

51.5" - 94" WIDE silver: PGSUS2-S
black: PGSUS2-B

- Standard variable graphic height = 67.75" - 96.5"
- single or double sided graphics
- linking connectors attach multiple units together
- telescopic poles for adjustable graphic width and height



TRIO

31.5" WIDE TRIO

- variable graphic height = 28.75" - 84"
- tri-pod banner stand
- hardware included supports single and double sided graphic
- stable, anodized aluminum
- telescopic pole for adjustable graphic height
- quick & easy to set up



Includes hardware for double sided graphics



TRIO LITERATURE POCKET

31.5" WIDE TRIO-LP

- 3 pocket add on literature dispenser to attach to a TRIO banner stand
- graphic height with literature pocket = 44"



ECONOMY SPRING BACK BANNER STANDS



Economy Spring Back banner stands incorporate basic design features, functionality and reliability. Economy banners include a basic carry bag and feature a 90-day hardware warranty. Also available in bulk buying options.



LIGHTNING

31" WIDE LTNG



- standard graphic height = 77"
- snap-lock graphic rails
- 3-piece bungee pole



L-MINI

14.25" WIDE L-MINI



- standard height = 26.88"
- tabletop tension banner stand
- adhesive rail
- anodized silver finish



SPRING 1-1

23.5" WIDE SB-1-1

- graphic height = 59" or 78"

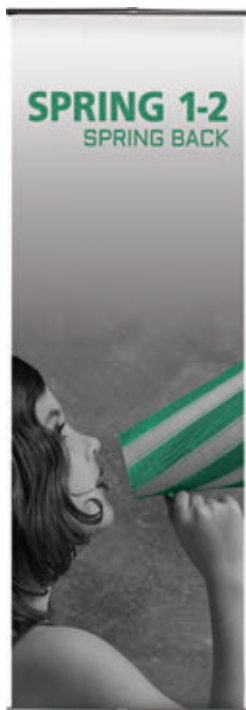

SPRING 1-2

26.5" WIDE SB-1-2

- graphic height = 59" or 78"



SPRING 1-3

35.125" WIDE SB-1-3

- graphic height = 59" or 78"





ECONOMY SPRING BACK BANNER STANDS



SPRING 3

27.5" WIDE SB-3

- standard graphic height = 70.75"
- #3 grommets in corners
- single or double sided



SPRING 4

27" WIDE SB-4

- standard graphic height = 62.25"
- #3 grommets in corners



SPRING 6

24.5" WIDE SB-6

- standard graphic height = 63"
- #3 grommets in corners



SPRING 7

29.5" WIDE SB-7

- variable graphic height = 61.5" - 69"
- #3 grommets in corners



FORMULATE™ ESSENTIAL BANNER DISPLAYS



Formulate™ Essential banner displays feature basic tubular frames coupled with pillowcase fabric graphics. The economy tube frames come with a one-year limited warranty. Simply pull the graphic over the frame.

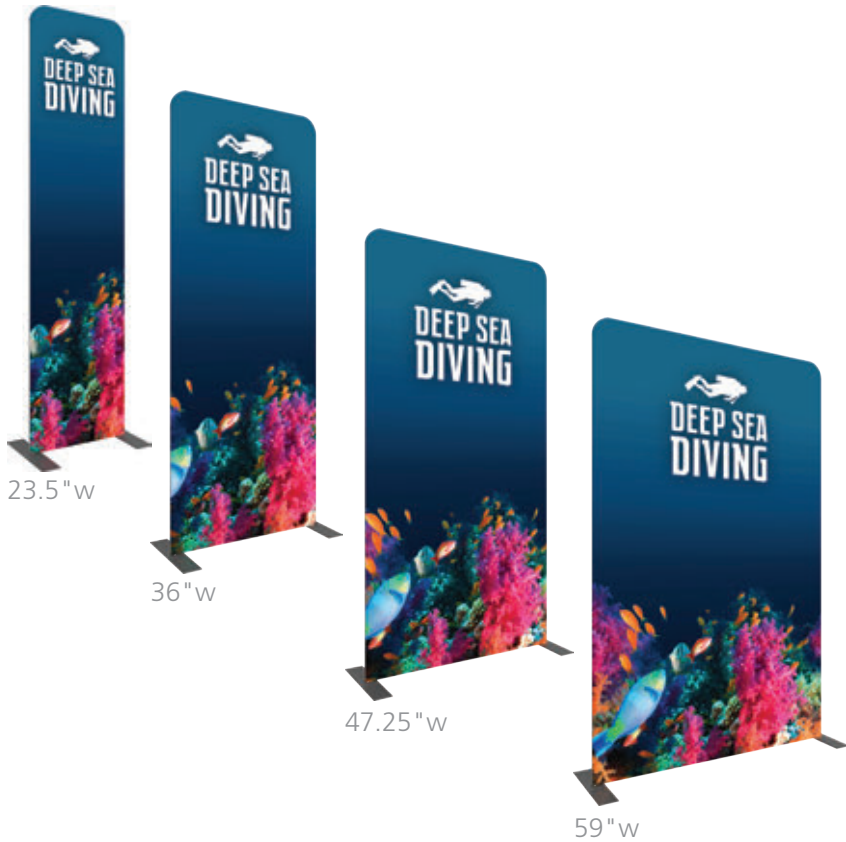

23.5" w

36" w

47.25" w

59" w

FORMULATE ESSENTIAL BANNER – STRAIGHT

23.5" WIDE FMLT-ESS-S-600

36" WIDE FMLT-ESS-S-920

47.25" WIDE FMLT-ESS-S-1200

59" WIDE FMLT-ESS-S-1500

- standard graphic height = 92"
- standard depth = 17.72"
- straight aluminum tube frame
- rounded corners
- bungee cords for easy assembly
- sturdy feet anchor the display
- pillowcase fabric graphic
- comes with carry bag



23.5" w

36" w

47.25" w

59" w

FORMULATE ESSENTIAL BANNER – CURVED

23.5" WIDE FMLT-ESS-C-600

36" WIDE FMLT-ESS-C-920

47.25" WIDE FMLT-ESS-C-1200

59" WIDE FMLT-ESS-C-1500

- standard graphic height = 92"
- standard depth = 23.96"
- curved aluminum tube frame
- rounded corners
- bungee cords for easy assembly
- sturdy feet anchor the display
- pillowcase fabric graphic
- comes with carry bag



FORMULATE™ ESSENTIAL BANNER DISPLAYS



COBRA FMLT-ESS-COBRA

36.25" w x 89.5" h x 34.5" d
The Cobra is a single or double sided fabric banner stand. Simply connect the basic lightweight aluminum tube frame, slip the fabric graphic on and you have a sleek serpentine-curved banner stand in minutes. Includes a canvas carry bag.



ENTICE FMLT-ESS-ENTICE-01 FMLT-ESS-ENTICE-02

31.5" w x 89.5" h - 99.13" h x 17.88" d
Entice is a double sided tension fabric display stand that features a small, clear acrylic shelf. Entice is offered with a curved or sloped top and allows you to dress up any space with your own graphic. Entice comes with a canvas over-the-shoulder carry bag. Shelf spans 34.5" w and is 6.25" deep, and can hold a maximum of 15 lbs.



SHARK FIN SHARK-FIN

70" w x 86" h x 17.7" d
The Formulate™ Shark Fin is an ideal banner for any indoor event. Simply slip the fabric graphic over the frame and you have an instant display. Includes a wheeled, molded storage case (OCB).



FORMULATE FABRIC BANNER FMLT-WV03-01

36" w x 92.7" h x 24" d
A sophisticated display for any space, the Formulate Vertical Curve fabric banner combines a lightweight aluminum frame with a zipper-pillowcase graphic. Includes a wheeled, molded storage case (OCL).



easy to apply
pillowcase
fabric graphics



bungee corded
poles allow for
simple assembly*

*select Formulate banners feature bungee cords

VECTOR FRAME™ FABRIC LIGHT BOXES

Vector Frame™ fabric light boxes feature durable 4" aluminum extrusion frames, push-fit INTENSITY backlit fabric graphics and LED edge lighting. Single and double sided graphic options are available.



LIGHT BOXES



01 Rectangle
VF-LB-R-01
36.3" w x 47.49" h x 19.69" d
comes in 1 OCE case



02 Rectangle
VF-LB-R-02
36.3" w x 71.12" h x 19.69" d
comes in 1 OCH case

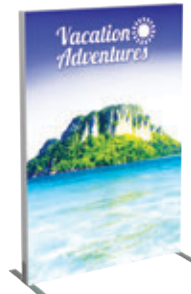

03 Rectangle
VF-LB-R-03
48.11" w x 71.12" h x 19.69" d
comes in 1 OCH case



05 Rectangle
VF-LB-R-05
118.99" w x 94.74" h x 19.69" d
comes in 1 OCH case



01 Square
VF-LB-S-01
36.3" w x 35.68" h x 19.69" d
comes in 1 OCE case



02 Square
VF-LB-S-02
48.11" w x 47.49" h x 19.69" d
comes in 1 OCE case



03 Square
VF-LB-S-03
71.73" w x 71.12" h x 19.69" d
comes in 1 OCH case



04 Square
VF-LB-S-04
95.35" w x 94.49" h x 19.69" d
comes in 1 OCH case



All Vector Frame displays are made in the USA and have a limited lifetime hardware warranty.

VECTOR FRAME™ FABRIC BANNERS

Vector Frame™ fabric banners combine aluminum extrusion frames with push-fit fabric graphics to create a versatile banner, backwall, hanging art or display. Vector Frame banners can be used to display messaging or art in a corporate environment or at a tradeshow and feature a 2" aluminum extrusion frame and single or double sided graphics.



fits perfect
in a 10' space

05 Rectangle
VF-R-05
118.98" w x 94.74" h x 19.69" d
comes in 1 OCL case



easy to apply
push-fit fabric graphics

BANNERS



01 Rectangle
VF-R-01
36.3" w x 47.49" h x 19.69" d
comes in 1 OCL case

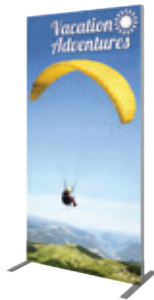

02 Rectangle
VF-R-02
36.3" w x 71.12" h x 19.69" d
comes in 1 OCS case



03 Rectangle
VF-R-03
48.11" w x 71.12" h x 19.69" d
comes in 1 OCL case

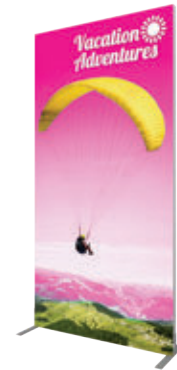

04 Rectangle
VF-R-04
48.11" w x 94.74" h x 19.69" d
comes in 1 OCL case



01 Square
VF-S-01
36.3" w x 35.68" h x 19.69" d
comes in 1 OCS case



02 Square
VF-S-02
48.11" w x 47.49" h x 19.69" d
comes in 1 OCL case



03 Square
VF-S-03
71.73" w x 71.12" h x 19.69" d
comes in 1 OCS case



04 Square
VF-S-04
95.35" w x 94.74" h x 19.69" d
comes in 1 OCL case



All Vector Frame displays are made in the USA and have a limited lifetime hardware warranty.

VECTOR FRAME™ FABRIC CURVED BANNERS

Vector Frame™ curved banners combine 2" aluminum extrusion frames with push-fit fabric graphics to create a versatile single and double sided banner, backwall or interior display. Use as a concave or convex shape.



01 Curved Rectangle
VF-CR-01
39.33" w x 94.74" h x 19.69" d
comes in 1 OCL case

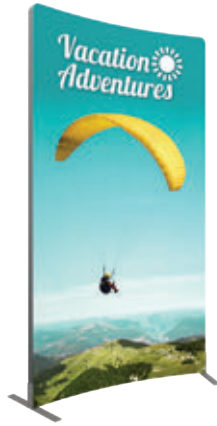

02 Curved Rectangle
VF-CR-02
56.75" w x 94.74" h x 19.49" d
comes in 1 OCL case



03 Curved Rectangle
VF-CR-03
68" w x 94.74" h x 18.75" d
comes in 1 OCE case

VECTOR FRAME MONITOR KIOSKS

Vector Frame™ Monitor Kiosks are a sleek, stylish way to display media at any tradeshow, event, in a retail or corporate space. The kiosks feature push-fit fabric graphics, easy-to-assemble 4" extrusion frames, your choice of single or double sided graphics and one or two monitor mounts (monitors not included). These kiosks complement the Vector Frame line of banners, backwalls, exhibit kits and counters.



01 Monitor Kiosk
VF-MK-01-SS
VF-MK-01-DS
36.3" w x 94.74" h x 19.69" d
comes in 1 OCH case
supports 26-40" monitor*;
max weight = 25 lbs each

front with graphic & monitor mount*



back with graphic



back with graphic & monitor mount*



top view
one monitor mount



02 Monitor Kiosk
VF-MK-02-SS
VF-MK-02-DS
48.11" w x 94.74" h x 19.69" d
comes in 1 OCH case
supports 26-40" monitor*;
max weight = 25 lbs each

front with graphic & monitor mount*



back with graphic



back with graphic & monitor mount*



top view
two monitor mounts

*Monitors not included.

VECTOR FRAME™ EDGE POSTER FRAMES

Vector Frame™ Edge fabric poster displays combine durable, slim 3/4" lightweight aluminum extrusion frames and easy-to-apply push-fit fabric graphics. Custom frame sizes are available.



Square Sizes:

- VFE-S-01: 11.8" w x 11.8" h
- VFE-S-02: 23.62" w x 23.62" h
- VFE-S-03: 35.43" w x 35.43" h
- VFE-S-04: 47.24" w x 47.24" h
- VFE-S-05: 59.06" w x 59.06" h

Rectangle Sizes:

- VFE-R-01: 11.8" w x 23.62" h
- VFE-R-02: 11.8" w x 35.43" h
- VFE-R-03: 23.62" w x 35.43" h
- VFE-R-04: 23.62" w x 47.24" h



Features Include:

- slim, lightweight 3/4" aluminum frame
- easy-to-apply push-fit fabric graphic
- direct to wall mounting
- custom frame sizes available



use as posters in a retail setting

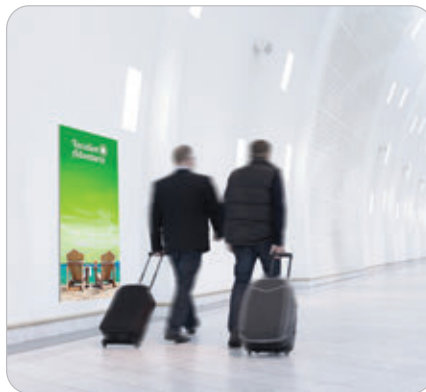

use as directional signs



use as advertisements



All Vector Frame displays are made in the USA and have a limited lifetime hardware warranty.

CAFÉ BARRIER

CB-K-1500
CB-EXT-K-1500



- indoor/outdoor modular display system
- stylish way to define areas or dictate traffic flow in or outside restaurants, bars, retail establishments, airports, museums, casinos and at tradeshows
- visual graphic area = approx. 53.25" w x 30.5" h
- heavy-duty stainless steel posts, base and 59" w rails
- unit kit, extension kit and individual components available



Café Barrier Kit:

CB-K-1500

- comes with top and bottom poles – 59" w,
2 uprights & 2 bases

Café Barrier Extension Kit:

CB-EXT-K-1500

- comes with top and bottom poles – 59" w,
1 upright & 1 base



great for
outdoor
use too!



use as outdoor café barriers



use for crowd control



use to guide traffic



AERO

11 GRAPHIC HEIGHT OPTIONS AVAILABLE

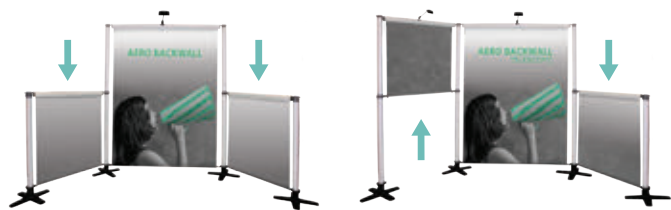

configure height by moving top cassette downwards



configure height by moving bottom rail upwards

- indoor modular display system
- standard graphic width = 47"
- graphics pull down from cassette
 - 11 graphic height options
- available as a kit and "à la carte" to create more combinations

Aero Basic Kit:

AERO2-1200-BASIC

- comes with 3 cassettes and 4 uprights with bases

Aero Complete Kit:

AERO2-1200-KIT

- comes with 3 cassettes, 4 uprights with bases, 3 LUM-200-ORL lights and rolling carry bag



CLAMP
UC-AERO



TABLET HOLDER
UC-VESA-BRKT



LIT HOLDER BRACKET
UC-LIT-BRKT-ABH-02
UC-LIT-BRKT-ABH-03



SHELF BRACKET
UC-SHLF-BRKT-01-CIR
UC-SHLF-BRKT-02-TRI
UC-SHLF-BRKT-03-SQU

UNIVERSAL ACCESSORIES

The new Universal Accessory system is designed to give you the freedom to add and change your accessories whenever you need to. Using the clamp that fits to the post, attach either a literature holder, a shelf or a TV/tablet bracket.



CAPTURE.YOUR.ATTENTION. OUTDOOR DISPLAYS

One-stop-shop for all your outdoor signage needs • The Zoom™ line of outdoor flags span heights of 8' to over 16' • Great for outdoor sporting events and arenas, concerts, festivals or to draw attention to any storefront • Strong, solid, stable, wind-resistant, durable • Graphics are long-lasting and can endure exposure to outdoor elements

OUTDOOR DISPLAYS

The Exhibitors' Handbook™ offers a collection of portable, off-the-shelf outdoor tents, flags and signs of a variety of types and sizes. Combining durable, sustainable hardware with state-of-the-art printed graphics creates outdoor displays and environments that make an impact.

Outdoor events such as festivals, street fairs, arts and craft shows and sporting events are perfect opportunities for promotional tents and signage to clearly display your company name, brand and message to attract visitors and buyers. Choose from off-the-shelf tents and related accessories, flags and portable billboards to make your event a success.



Shown above are the Zoom™ 10' PopUp Tent frame with printed canopy and additional accessories – full backwall and half wall hardware and graphics. Also featured is the Tubular 10' Dome Tent, Monsoon portable billboard, Zoom 04 feather flag and 6' printed table throw.



ZOOM™ 10' POPUP TENT



ZOOM™ 20' POPUP TENT



TUBULAR 10' DOME TENT

ZOOM™ POPUP TENTS



- 10' opens to base size of 9.6' x 9.6'; 20' opens to base size of 9.6' x 19.6'
- rust-resistant aluminum extrusion frame is completely self-contained with no loose parts
- 10' and 20' canopy offered in 5 standard colors and can also be custom printed
- polyester canopies and sidewalls are water and UV-resistant
- hardware only kit includes frame, stakes, guy lines and rolling carrying bag
- canopy kits include canopy (standard colors or custom printed), hardware frame, stakes, guy lines and rolling carrying bag
- sidewalls and rail skirts offered in standard colors and custom prints; sold separately
- folds compactly into portable, rolling carry bag

ZOOM™ 10' POPUP TENT



- hardware only kit: TNT-3MX3M-FRM-HEX
- kit with canopy: TNT-3MX3M-HEX-(COLOR OR G)
- stock canopy only: TNT-3MX3M-CAN-(COLOR)
- printed canopy only: TNT-3MX3M-CAN-G
- full wall kits: TNT-3MX3M-FLL-WLL-(COLOR OR G)
- half wall kits: TNT-3MX3M-HLF-WLL-K-(COLOR OR G)

Stock canopy tops and walls available in:



- Red – 186C
- Blue – 286C
- Grey – 429C
- White
- Black



digitally printed canopies, sidewalls and backwalls available

ZOOM™ 20' POPUP TENT

- hardware only kit: TNT-3MX6M-FRM-HEX
- kit with canopy: TNT-3MX6M-HEX-(COLOR OR G)
- stock canopy only: TNT-3MX6M-CAN-(COLOR)
- printed canopy only: TNT-3MX6M-CAN-G
- full wall kits: TNT-3MX6M-FLL-WLL-(COLOR OR G)
- half wall kits: TNT-3MX6M-HLF-WLL-K-(COLOR OR G)



shown with optional Zoom™ Tent Flag, which attaches to any upright pole of the Zoom Popup Tent TNT-ZOOM-ACC



10'w & 20'w tents come in roller bag(s)



INFLATABLE 10' DOME TENT

TNT-INF-3MX3M



- base size of 9.84' x 9.84'
- sturdy vinyl body inflates easily with air compressor
- inflates in less than 10 minutes
- printed canopies & sidewalls are water and UV-resistant
- hardware only kit includes inflatable frame, air pump, guy lines, stakes and carry bag
- canopy kits include canopy, inflatable frame, air pump, guy lines, stakes and carry bag
- zipper-attached printed sidewalls sold separately
- folds compactly into a carry bag and will fit in most vehicles



TUBULAR 10' DOME TENT

TNT-TDT-10



- base size of 9.6' x 9.6'
- aluminum tubular frame assembles quickly and easily with use of snap button connectors
- custom printed canopy is water and UV-resistant
- hardware kit includes frame
- canopy kits include canopy, frame and cases
- easily disassembles and stores compactly in two OCE hard shell expandable cases



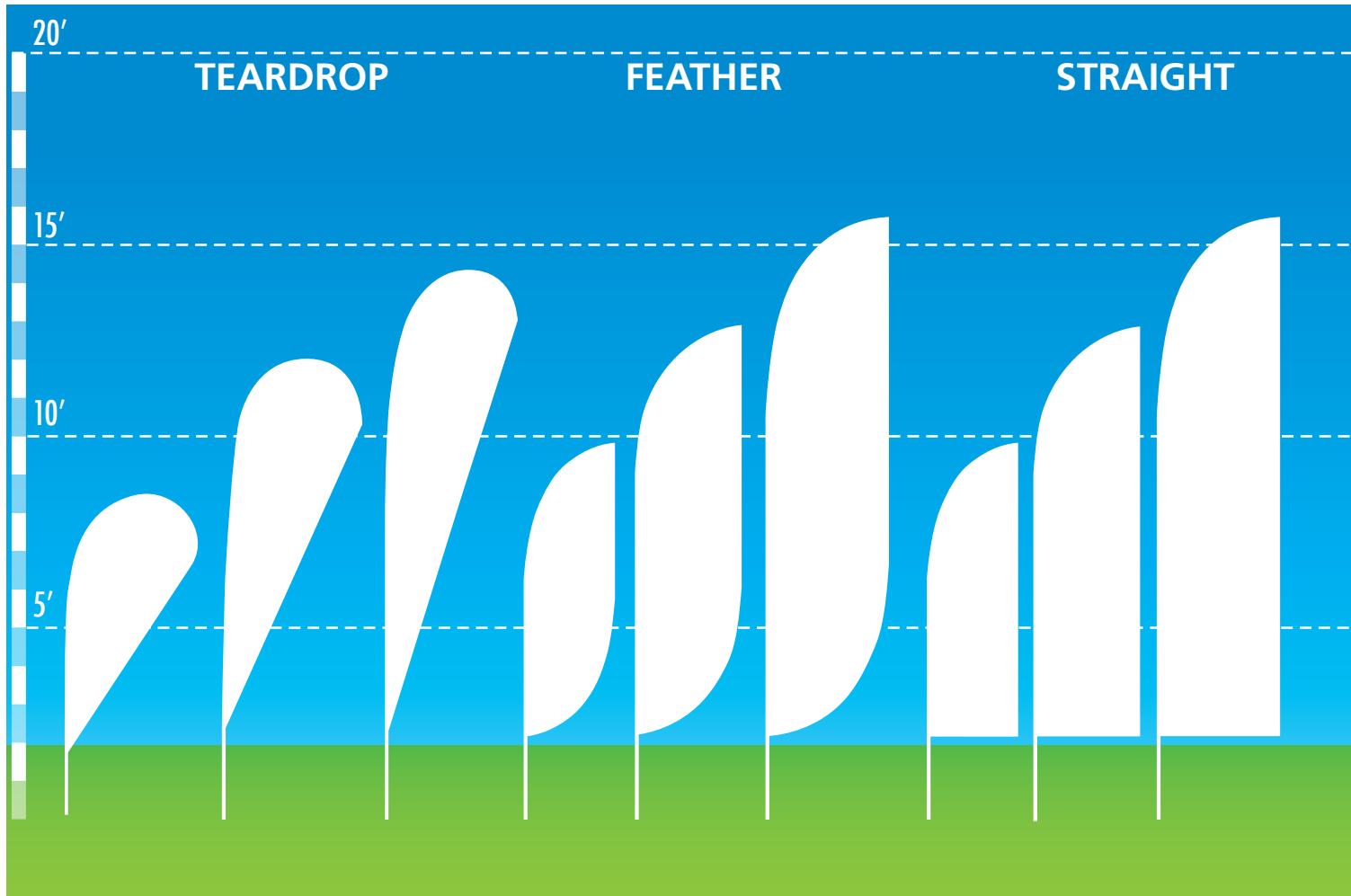

ZOOM™ FLAGS

- can be used indoors or outdoors
- graphic rotates in wind
- water fillable donut adds stability to quad leg (optional upgrade)
- graphic printed on flag material
- double sided graphic available
- floor base & ground stake



shown with X-base and optional upgrade donut water fillable base ZOOM-INDOOR-BASE-SET



All Outdoor products have a one year limited hardware warranty and are eco-friendly.

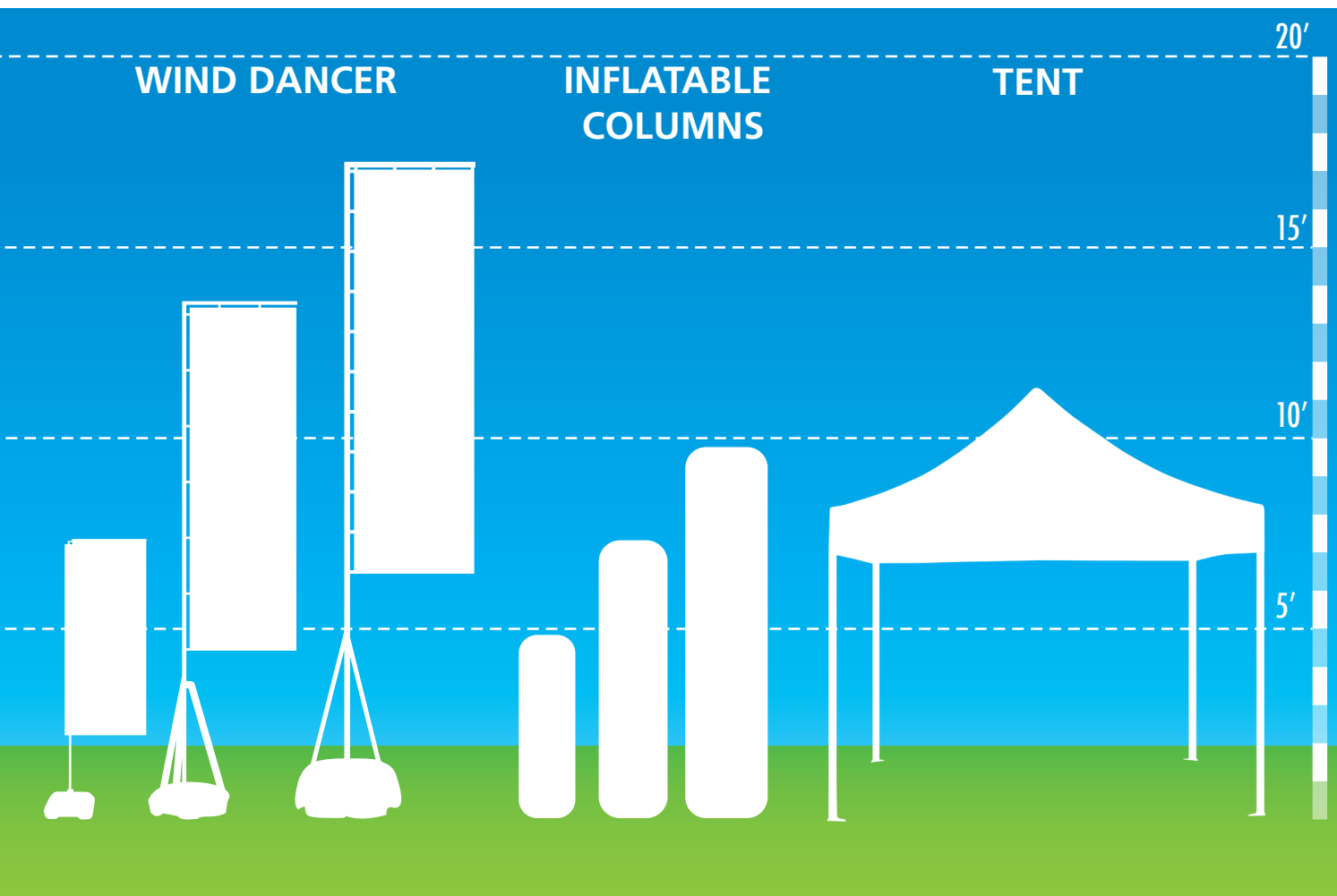

*not to scale, refer to graphic template

ZOOM™ BASE OPTIONS

STANDALONE BASES



atlas base + pin
(ATLAS +
ATLAS-ZOOM-PIN)



donut base
(ZOOM-INDOOR-
BASE-SET)



auger base
(ZOOM-AUG)



ground stake
(included)



drive-over base
(ZOOM-VEHICLE)



All Outdoor products have a one year limited hardware warranty and are eco-friendly.

OUTDOOR SIGNAGE

Outdoor signage, flags and displays are great for outdoor sporting events and arenas, concerts, festivals or to draw attention to any storefront. Outdoor display products are strong, solid, stable, wind-resistant and durable. Graphics are long-lasting and can endure exposure to outdoor elements.



- max approximate height = 8.5'



WIND DANCER MINI WIND-MIN

- adjustable graphic height = up to 6'
- economy outdoor flag
- plastic pole, easy push-fit assembly
- hollow plastic base can be filled with water or sand
- double sided graphic available



- max approximate height = 13.5'



WIND DANCER LT WIND-LT

- adjustable graphic height = up to 8'8"
- hollow base can be filled with either water or sand as weighing agent
- double sided graphic available
- optional carry bag



- max approximate height = 17.5'



WIND DANCER WIND-MX

- adjustable graphic height = up to 12'
- flag is approximately 43" wide
- hollow base can be filled with either water or sand as weighing agent
- double sided graphic available
- optional carry bag



ATLAS ATLAS

- outdoor sign or Zoom™ flag holder
- use as many as you need to hold a large rigid graphic .4"-.5" thick
- securely holds a Zoom 3, 4 or 5 outdoor flag pole with Zoom attachment (ATLAS-ZOOM-PIN optional upgrade)
- quick set-up, easy storage
- hollow plastic base can be filled with water or sand



WHIRLWIND WHRL-WND-2

- 31.1" w x 45.7" h x 19.7" d
- front-loading snap frames constructed from aluminum & powder-coated steel
- single or double sided
- includes clear lens cover
- dual-spring design flexes to withstand wind gusts
- compact durable base can be filled with water or sand for extra stability
- integrated wheel set



CAFÉ BARRIER CB-K-1500 CB-EXT-K-1500

- indoor/outdoor modular display system
- stylish way to define areas or dictate traffic flow in or outside restaurants, bars, retail establishments, airports, museums, casinos and at tradeshows
- visual graphic area = approx. 53.25" w x 30.5" h
- heavy-duty stainless steel posts, base and 59" w rails
- unit kit, extension kit and individual components available



INFLATABLE COLUMNS



INF-COL-S: 18.5" dia. x 53.75" h
INF-COL-M: 18.5" dia. x 92.75" h
INF-COL-L: 18.5" dia. x 115.25" h

- freestanding inflatable column
- indoor/outdoor use
- hollow plastic base can be filled with water or sand
- custom printed canvas graphics are waterproof
- stays inflated without air pump
- pump and ground stakes sold separately
- tabs with grommets for optional stake usage



PARKWAY

single span: PKWY-S-SPN-3
double span: PKWY-D-SPN-3

- single span = 32" w x 60" h
- double span = 67" w x 60" h
- withstands winds up to 38MPH
- single or double span street pole banner



ZOOM™ BACKPACK FLAGS



ZOOM-BKPK

- can be used with four different flag types/shapes
 - teardrop, feather, straight and X-banner style
- poles and rods that support every style flag fit within the backpack
- reinforced straps, adjustable belt and padding all help with stability and comfort
- reinforced straps and flag mounting system
- mesh side-pockets and a zipped compartment add more storage
- bag made from coated nylon



X-BANNER

FEATHER

TEARDROP

STRAIGHT

OUTDOOR SIGNAGE



Outdoor signage, flags and displays are great for outdoor sporting events and arenas, concerts, festivals or to draw attention to any storefront. Outdoor display products are strong, solid, stable, wind-resistant and durable. Graphics are long-lasting and can endure exposure to outdoor elements.

SPRING 5

SB-5



- standard graphic height = 70.75"
- 31.5" wide
- indoor or outdoor use
- single or double sided
- hollow base can be filled with either water or sand as weighing agent
- easy grommet graphic attachment
- tension pole system



BLIZZARD

BLZD



- max width x min height: 40"w x 49.5"h
- min width x max height: 23.5"w x 80"h
- max width x max height: 40"w x 74.5"h
- min width x min height: 23.5"w x 49.5"h
- outdoor banner stand
- hollow base can be filled with either water or sand as weighing agent
- easy grommet graphic attachment



THUNDER

THUNDER



- visual graphic area = approx. 33.5"w x 79.7"h
- double sided outdoor retractable banner stand
- large twist-lock feet
- stakes included to secure to ground
- snap-top graphic rail
- 3-piece bungee pole



MONSOON

MONSN-2



- visual graphic area = approx. 92.125"w x 32"h
- semi-portable single or double sided billboard
- easy grommet graphic attachment
- includes ground stakes & bungee rope





ROUND PROMOTIONAL UMBRELLA

- printed promotional umbrella – 8’5” dia. canopy
- canopy also available in off-white, green and burgundy stock colors
- can be used for commercial or residential use
- steel poles and arms are white
- overall height with umbrella = 94”
- carry bag included



off-white



hunter green



burgundy

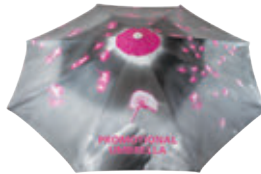

TOP VIEW

*base sold separately

STOWAWAY

- STOW-S: 53" w x 27" h x 23.25" d
- STOW-M: 81.75" w x 34.25" h x 23.75" d
- STOW-L: 101" w x 38.38" h x 24.75" d

- high visual impact display stand
- indoor/outdoor use
- extremely lightweight
- includes carry bag & 4 ground stakes
- no tools required
- custom printed graphics
- available in three sizes



small



medium



large

ground stakes included

SQUARE PROMOTIONAL UMBRELLA

- printed promotional umbrella, water-resistant
- can be used for commercial or residential use
- white frame
- overall height with umbrella = 109”
- carry bag included



TOP VIEW

*base sold separately



MEET.AND.GREET. TABLE THROWS & RUNNERS

One-stop-shop for the fastest table throws and runners • Can be used in many ways; perfect to display your messaging in any tradeshow or event – indoor or outdoor • Printed, imprinted, convertible, stretch and fitted options to choose from • Sizes of 4', 6', 8', full and economy • Choose from 11 fabric colors and 21 vinyl colors

PRINTED TABLE THROW

- 4' full: TBL-T-4-F
- 4' economy: TBL-T-4-E
- 6' full: TBL-T-6-F
- 6' economy: TBL-T-6-E
- 8' full: TBL-T-8-F
- 8' economy: TBL-T-8-E

- complete your presentation with a premium printed table throw
- lends a polished appearance to any display
- maximize your advertising with additional space to display your message



carry bags available,
fits 4 or 6 table throws
TBL-THRW-BG
TBL-THRW-BG2

shown with
Horizon Standard
tabletop folding
panel display
(page 63)



CONVERTIBLE TABLE THROW

- convertible full: TBL-T-FC
- convertible economy: TBL-T-EC

- printed throw converts quickly and easily to fit both a 6' and 8' table
- Velcro tabs make conversion simple



shown as 8' convertible table throw

TABLE RUNNERS

- 24" full: TBL-R-24-F
- 24" economy: TBL-R-24-E
- 30" full: TBL-R-30-F
- 30" economy: TBL-R-30-E
- 36" full: TBL-R-36-F
- 36" economy: TBL-R-36-E
- 60" full: TBL-R-60-F
- 60" economy: TBL-R-60-E

- accent your solid colored table throw with a full color printed runner
- available in four widths



All table throws and runners come with a graphic limited warranty of 6 months and are made in the USA.

FITTED TABLE THROW

4' full: TBL-FT-4-F

6' full: TBL-FT-6-F

8' full: TBL-FT-8-F

- form fitted to fit 4', 6' & 8' tabletops
- optional carry bag available
- fitted fabric dye-sublimated printed table throw lends a polished look to any display



STRETCH TABLE THROW

4' full: TBL-SW-4-F

6' full: TBL-SW-6-F

8' full: TBL-SW-8-F

- tailored to fit 4', 6' & 8' tables top to bottom
- optional carry bag available
- stretch fabric dye-sublimated printed table throw lends a stylish look to any display
- zipper in the back provides access to underneath the table



ROUND TABLE THROWS

30" dia., 30"h draped, fitted & stretch options

30" dia., 42"h draped, fitted & stretch options

48" dia., 30"h draped & fitted options

60" dia., 30"h draped & fitted options

- tailored to fit round tables
- printed on premium dye-sublimated fabric
- all options lend a stylish and polished look to any event



All table throws and runners come with a graphic limited warranty of 6 months and are made in the USA.

IMPRINTED TABLE THROW

- 6' full
- 6' economy
- 8' full
- 8' economy

- 11 standard table throw colors
- 21 standard vinyl options
- maximum logo size = 60" w x 21.5" h (see template for details)
- must be simple vector artwork, no complex logos or gradients
- maximum two vinyl colors per logo imprint
- referenced Pantone colors are not exact
- vinyl is heat transferred



full table throw shown in purple fabric with white and sky blue imprinted vinyl



economy table throw leaves back of table exposed for easy access to storage

FULL TABLE THROW

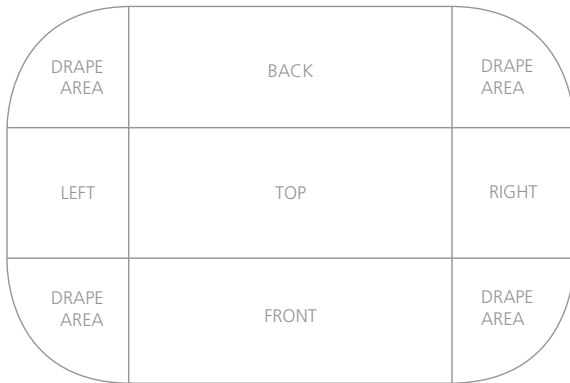

ECONOMY TABLE THROW

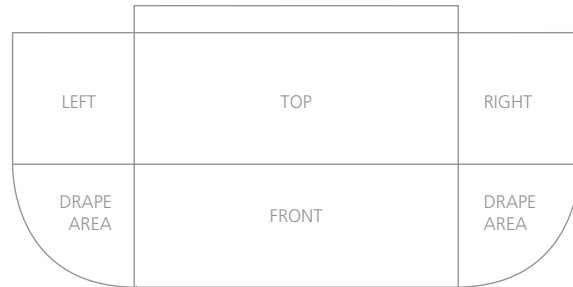

FABRIC COLORS

red Pantone® 201C	royal blue Pantone® 661C	purple Pantone® Violet C	yellow Pantone® 1235C
beige Pantone® 728C	burgundy Pantone® 504C	gray Pantone® 422C	hunter green Pantone® 350C
navy Pantone® 282C	black	white	

VINYL COLORS

black	white	blue Pantone® 293C	hot pink Pantone® Process Magenta C	royal purple Pantone® 2755C	red Pantone® 200C	vegas gold Pantone® 467C
kelly green Pantone® 342C	sky blue Pantone® 283C	lemon yellow Pantone® 101C	medium yellow Pantone® 123C	burnt orange Pantone® 167C	orange Pantone® 021C	gray Pantone® Cool Gray 9C
navy Pantone® 2766C	apple green Pantone® 368C	forest green Pantone® 350C	vanilla cream Pantone® 7499C	sapphire blue Pantone® 2925C	brown Pantone® 1545C	teal Pantone® 315C



All table throws and runners come with a graphic limited warranty of 6 months and are made in the USA.



FAST.DYNAMIC.FABRIC. HOPUP™ TENSION FABRIC

Combining style and speed, the attached fabric graphic makes the Hopup™ the fastest display on the market • The Hopup is one of the most dynamic and popular large format graphic displays due to its maximum impact with minimal effort • Lightweight and highly portable • Easy to set up and packs away as fast as it sets up



HOPUP™ BACKWALLS

The Hopup™ is one of the most dynamic and popular large format graphic displays due to its maximum impact with minimal effort. Hopup Tension Fabric Displays come in a variety of sizes and are offered in straight and curved frames. Hopups require no tools for assembly, are lightweight and highly portable and they pack away as easy as they set up! LED lighting makes the Hopup glow and stand out even more.



optional interior lights are attached with Velcro to back fabric panel

BACKLIT HOPUP™

- lightweight, heavy-duty silver frame
- supports an integrated full fitted fabric graphic mural with end caps only
- available in 5', 7 ½' or 10' sizes (curved only)
- LED lights include one year limited warranty
- comes in an OCX molded case



HOP-BL2X2-FGE-C



HOP-BL3X3-FGE-C



HOP-BL4X3-FGE-C

STRAIGHT HOPUP™ CONFIGURATIONS



2½' tabletop
footprint dimensions:
31" w x 31" h x 12.25" d
HOP-1X1FG-S



5' tabletop
footprint dimensions:
60.5" w x 31" h x 12.25" d
HOP-2X1FG-S



5' tabletop
footprint dimensions:
60.5" w x 60.5" h x 12.25" d
HOP-2X2FG-S



7½' tabletop
footprint dimensions:
89.5" w x 60.5" h x 12.25" d
HOP-3X2FG-S



2½' full height standard display
footprint dimensions:
31" w x 90" h x 29" d
HOP-1X3FG-S



5' full height standard display
footprint dimensions:
60.5" w x 90" h x 29" d
HOP-2X3FG-S



7½' full height standard display
footprint dimensions:
89.5" w x 90" h x 29" d
HOP-3X3FG-S

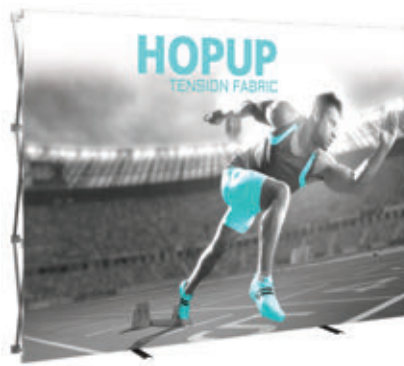

10' full height standard display
footprint dimensions:
119" w x 90" h x 29" d
HOP-4X3FG-S



12¼' full height standard display
footprint dimensions:
147.25" w x 90" h x 29" d
HOP-5X3FG-S

HOPUP™ COUNTER HOP-CT-2

- collapsible display counter
- easy-to-assemble
- includes clear internal shelf
- 41.75" w x 39.69" h x 14.25" d
- top available in four laminate finish options (page 70)



clear shelf



CURVED HOPUP™ CONFIGURATIONS



5½' tabletop
footprint dimensions:
64" w x 60.5" h x 12.25" d
HOP-2X2FGE-C



5½' tabletop
footprint dimensions:
64" w x 31" h x 12.25" d
HOP-2X1FGE-C



7½' tabletop
footprint dimensions:
92" w x 60.5" h x 12.25" d
HOP-3X2FGE-C



5½' full height standard display
footprint dimensions:
64" w x 89.5" h x 12.25" d
HOP-2X3FGE-C

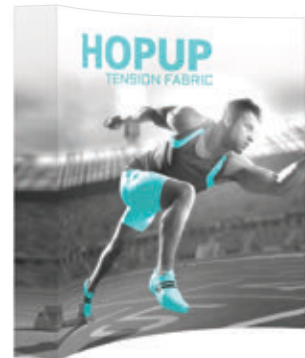

7½' full height standard display
footprint dimensions:
92" w x 89.5" h x 12.25" d
HOP-3X3FGE-C



10' full height standard display
footprint dimensions:
116.25" w x 89.5" h x 12.25" d
HOP-4X3FGE-C



11½' full height standard display
footprint dimensions:
136.5" w x 89.5" h x 12.25" d
HOP-5X3FGE-C

comes with a wheeled carry bag; optional hard cases available (page 80)



all sizes available with or without endcaps



All Hopup frames are eco-friendly, come with a rolling carry case, and have a limited lifetime warranty.

HOPUP™ BACKWALL DIMENSIONS

COMPLETE SYSTEMS WITH FRAMES



The Hopup™ is one of the most dynamic and popular large format graphic displays due to its maximum impact with minimal effort. Hopup Backwall Dimensions add style, flare and function to any 7 ½' or 10' Hopup straight display. Easily accessorize your Hopup with monitor mounts, counters, tables, and more messaging real estate. Purchase as a complete kit or as an accessory for your existing straight Hopup. Dimensional elements can be placed in the middle, left or right sides of the display.



DIMENSION KIT 01
HOP-DIM01-3X3FG-S

- 7 ½' full height straight backwall
- 2 stand-off rigid graphic accents with literature holders
- monitor* mount supports 23" monitor, max weight = 30 lbs
- 2 Lumina 200 lights



DIMENSION KIT 02
HOP-DIM02-3X3FG-S

- 7 ½' full height straight backwall
- stand-off counter supports max 25 lbs
- counter features graphic and literature holder
- monitor* mount supports 23" monitor, max weight = 30 lbs
- 2 Lumina 200 lights



DIMENSION KIT 03
HOP-DIM03-4X3FGE-S

- 10' full height straight backwall
- accessory counter features:
 - monitor* mount supports 40" monitor, max weight = 50 lbs
 - counter top holding max weight of 35 lbs
 - printed fabric graphic and literature holder
- 2 Lumina 200 lights



DIMENSION KIT 04
HOP-DIM04-4X3FGE-S

- 10' full height straight backwall
- standoff counter features:
 - fabric graphic messaging area (top)
 - printed fabric graphic (bottom)
 - counter top holding max weight of 35 lbs
- 2 Lumina 200 lights

Hopup Dimensions counter tops are available in your choice of four thermoform finishes

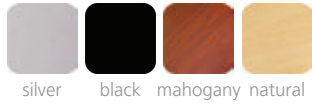

HOPUP™ BACKWALL DIMENSIONS ACCESSORY KITS

The Hopup™ is one of the most dynamic and popular large format graphic displays due to its maximum impact with minimal effort. Hopup Backwall Dimensions add style, flare and function to any 7 ½' or 10' Hopup straight display. Easily accessorize your Hopup with monitor mounts, counters, tables, and more messaging real estate. Purchase as a complete kit or as an accessory for your existing straight Hopup. Dimensional elements can be placed in the middle, left or right sides of the display.



ACCESSORY 01
HOP-DIM01

- 2 stand-off rigid graphic accents with literature holders
- monitor* mount supports 23" monitor, max weight = 30 lbs



ACCESSORY 02
HOP-DIM02

- stand-off counter supports max 25 lbs
- counter fabric graphic and literature holder
- monitor* mount supports 23" monitor, max weight = 30 lbs

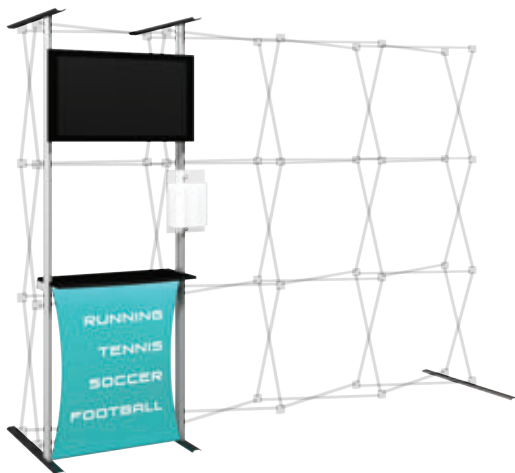

ACCESSORY 03
HOP-DIM03

- accessory counter features:
 - monitor* mount supports 40" monitor, max weight = 50 lbs
 - counter top holding max weight of 35 lbs
 - printed fabric graphic and literature holder



ACCESSORY 04
HOP-DIM04

- standoff counter features:
 - fabric graphic messaging area (top)
 - printed fabric graphic (bottom)
 - counter top holding max weight of 35 lbs

*Frames and monitors not included.



EMBRACE.THE.FRAME. PUSH-FIT TENSION FABRIC

Embrace's push-fit fabric graphic hugs the collapsible frame and makes this portable display sleek and seamless • Embrace couples a lightweight, portable collapsible frame with a seamless, push-fit fabric graphic, creating a modern appearance • Assembly is simple; pop up the frame, attach the channels for the graphic, then push the graphic beading and graphic into the channel and you have a sophisticated display in a matter of minutes.



EMBRACE™ BACKWALLS

Embrace™ is one of the sleekest collapsible portable displays and it delivers style with minimal effort. Embrace Fabric Displays come in a variety of sizes and are offered with or without end caps. Embrace requires no tools for assembly, is lightweight and highly portable. Embrace features crisp, straight edges due to the simple, push-fit fabric attachment.



easy push-fit fabric graphics go into channel



EMBRACE™ BACKWALL

- lightweight anodized straight silver frame
- stabilizer feet on all frames 3 quads high
- simple assembly
- perimeter channel bars connect to frame and hold push-fit fabric graphic
- crisp, push-fit fabric graphic creates clean, straight edges; comes with front or fully fitted graphic (with end caps)
- dovetail on top hubs for lights to slide into
- rolling carry bag for most units

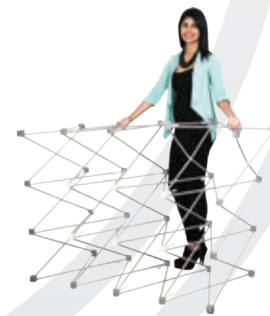

channel bars for insertion of fabric graphic easily connect and slide onto collapsible frame



easy snap arms

EMBRACE™ FRONT GRAPHIC CONFIGURATIONS



2½' tabletop footprint dimensions: 30.43" w x 30.74" h x 12.92" d
EMB-1X1FG-S



5' tabletop footprint dimensions: 59.95" w x 30.74" h x 12.92" d
EMB-2X1FG-S



5' tabletop footprint dimensions: 59.95" w x 59.95" h x 12.92" d
EMB-2X2FG-S



7½' tabletop footprint dimensions: 88.15" w x 59.59" h x 12.92" d
EMB-3X2FG-S



2½' full height standard display footprint dimensions: 31.1" w x 88.8" h x 28.94" d
EMB-1X3FG-S



5' full height standard display footprint dimensions: 59.95" w x 88.8" h x 28.94" d
EMB-2X3FG-S



7½' full height standard display footprint dimensions: 88.15" w x 88.8" h x 28.94" d
EMB-3X3FG-S



10' full height standard display footprint dimensions: 117" w x 88.8" h x 28.94" d
EMB-4X3FG-S

EMBRACE™ COUNTER EMB-CT

- 40.95" w x 40.23" h x 14.95" d
- collapsible display counter
- includes internal shelf
- push-fit fabric graphics
- top available in four laminate finish options (page 70)



clear shelf

EMBRACE | PUSH-FIT TENSION FABRIC



All Embrace frames are eco-friendly, come with a carry case, and have a limited lifetime warranty.

EMBRACE™ WITH ENDCAPS CONFIGURATIONS



2½' tabletop
footprint dimensions:
30.43" w x 30.74" h x 12.92" d
EMB-1X1FGE-S



5' tabletop
footprint dimensions:
59.95" w x 30.74" h x 12.92" d
EMB-2X1FGE-S



5' tabletop
footprint dimensions:
59.95" w x 59.95" h x 12.92" d
EMB-2X2FGE-S



7½' tabletop
footprint dimensions:
88.15" w x 59.59" h x 12.92" d
EMB-3X2FGE-S



2½' full height standard display
footprint dimensions:
31.1" w x 88.8" h x 28.94" d
EMB-1X3FGE-S



5' full height standard display
footprint dimensions:
59.95" w x 88.8" h x 28.94" d
EMB-2X3FGE-S



7½' full height standard display
footprint dimensions:
88.15" w x 88.8" h x 28.94" d
EMB-3X3FGE-S



10' full height standard display
footprint dimensions:
117" w x 88.8" h x 28.94" d
EMB-4X3FGE-S

comes with a carry bag or wheeled carry bag; optional hard cases available (page 80)



all sizes available with or without endcaps



All Embrace frames are eco-friendly, come with a carry case, and have a limited lifetime warranty.



BOLD.VIVID.SIMPLE. **XCLAIM™ FABRIC POPUP**

Combining dimension and simplicity • Xclaim™ couples a collapsible frame and magnetic locking arms with brilliant push-fit fabric graphics • Ease, style and the versatility Xclaim provides with simple graphic changes makes this system a top choice



XCLAIM™ FABRIC POPUP

The Xclaim™ fabric popup system features super stretch push-fit fabric graphics that come pre-attached to the collapsible frame to create sleek, polished displays. Displays are available in a variety of sizes and configurations, and the multitude of placement possibilities of the push-fit fabric graphics are endless! Using a lightweight magnetic collapsible frame, Xclaim displays require no tools for assembly, are portable, durable and set up and pack down fast and easily. Quickly command attention with the eye-catching Xclaim display system!



XCLAIM 3X3 KIT 03

XCLM-3X3-K3



XCLAIM™ FABRIC POPUP

Xclaim™ features super stretch push-fit fabric graphics that come pre-attached to the collapsible frame to create sleek, polished displays. Displays are available in a variety of sizes and configurations, and the multitude of placement possibilities of the push-fit fabric graphics are endless! Using lightweight, magnetic collapsible frame similar to the Coyote™ Popup line, Xclaim displays are portable, durable and set up and pack down fast and easily. Quickly command attention with the eye-catching Xclaim display system!

XCLAIM TABLETOP KITS



5' tabletop
footprint dimensions:
59.11" w x 59.42" h x 12.8" d
XCLM-2X2-K1



5' tabletop
footprint dimensions:
59.11" w x 59.42" h x 12.8" d
XCLM-2X2-K2



5' tabletop
footprint dimensions:
59.11" w x 59.42" h x 12.8" d
XCLM-2X2-K3



5' tabletop
footprint dimensions:
59.11" w x 59.42" h x 12.8" d
XCLM-2X2-K4



XCLAIM™ FABRIC POPUP

XCLAIM 2 ½'W FULL HEIGHT KITS



2 ½' full height display
footprint dimensions:
30.30" w x 88.23" h x 12.8" d
XCLM-1X3-K1



2 ½' full height display
footprint dimensions:
30.30" w x 88.23" h x 12.8" d
XCLM-1X3-K2



2 ½' full height display
footprint dimensions:
30.30" w x 88.23" h x 12.8" d
XCLM-1X3-K3



2 ½' full height display
footprint dimensions:
30.30" w x 88.23" h x 12.8" d
XCLM-1X3-K4

XCLAIM 5'W FULL HEIGHT KITS



5' full height display
footprint dimensions:
59.11" w x 88.23" h x 12.8" h
XCLM-2X3-K1



sleek hub for a
polished look



push-fit
fabric graphics



Add optional shelves, available
in four color options
XCLM-SHLF



5' full height display
footprint dimensions:
59.11" w x 88.23" h x 12.8" h
XCLM-2X3-K2



All Xclaim popups are eco-friendly and have a limited lifetime warranty.

XCLAIM™ FABRIC POPUP

XCLAIM 7 ½'W FULL HEIGHT KITS



7 ½' full height display
footprint dimensions:
87.92" w x 88.23" h x 12.8" d
XCLM-3X3-K1

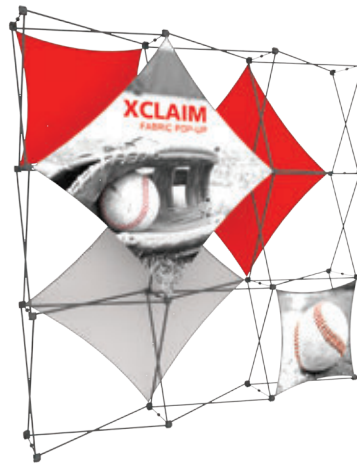

7 ½' full height display
footprint dimensions:
87.92" w x 88.23" h x 12.8" d
XCLM-3X3-K2



7 ½' full height display
footprint dimensions:
87.92" w x 88.23" h x 12.8" d
XCLM-3X3-K3

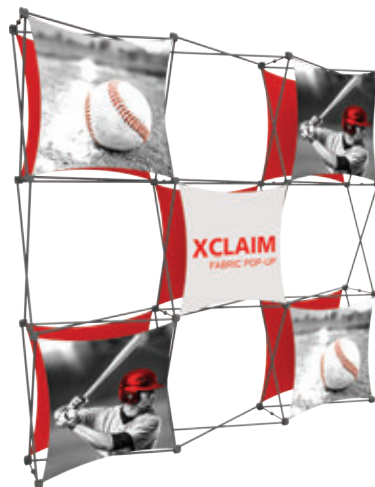

7 ½' full height display
footprint dimensions:
87.92" w x 88.23" h x 12.8" d
XCLM-3X3-K4



7 ½' full height display
footprint dimensions:
87.92" w x 88.23" h x 12.8" d
XCLM-3X3-K5

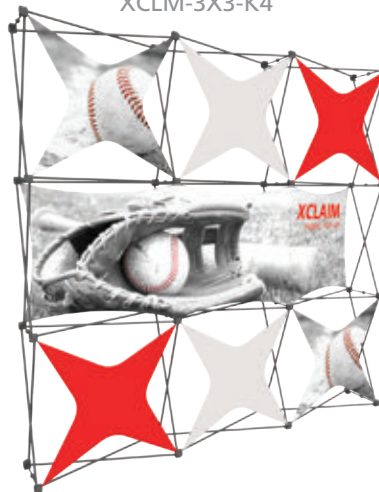

7 ½' full height display
footprint dimensions:
87.92" w x 88.23" h x 12.8" d
XCLM-3X3-K6



XCLAIM™ FABRIC POPUP

XCLAIM 10'W FULL HEIGHT KITS



10' full height display
 footprint dimensions:
 116.72" w x 88.23" h x 12.8" d
 XCLM-4X3-K1



10' full height display
 footprint dimensions:
 116.72" w x 88.23" h x 12.8" d
 XCLM-4X3-K2



10' full height display
 footprint dimensions:
 116.72" w x 88.23" h x 12.8" d
 XCLM-4X3-K3



sleek hub for a
 polished look



push-fit
 fabric graphics



Add optional shelves, available
 in four color options
 XCLM-SHLF



All Xclaim popups are eco-friendly and have a limited lifetime warranty.

XCLAIM™ FABRIC POPUP

XCLAIM 10'W FULL HEIGHT KITS



10' full height display
footprint dimensions:
116.72" w x 88.23" h x 12.8" d
XCLM-4X3-K4



10' full height display
footprint dimensions:
116.72" w x 88.23" h x 12.8" d
XCLM-4X3-K5



10' full height display
footprint dimensions:
116.72" w x 88.23" h x 12.8" d
XCLM-4X3-K6



sleek hub for a polished look

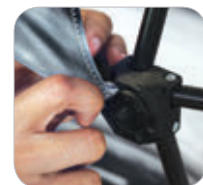

push-fit fabric graphics



Add optional shelves, available in four color options
XCLM-SHLF



XCLAIM™ FABRIC POPUP

XCLAIM 7'W KITS



7' display
footprint dimensions:
83.51" w x 63.14" h x 12.8" d
XCLM-3QP-K1

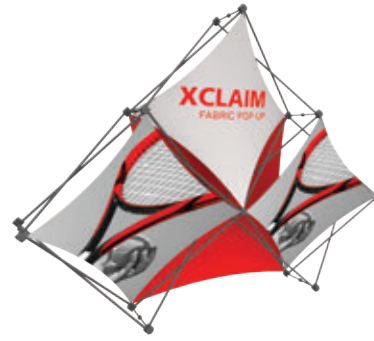

7' display
footprint dimensions:
83.51" w x 63.14" h x 12.8" d
XCLM-3QP-K2

XCLAIM 10'W KITS

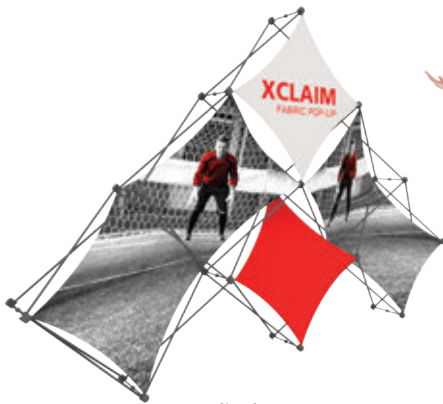

10' display
footprint dimensions:
124.25" w x 83.51" h x 12.8" d
XCLM-6QP-K1



10' display
footprint dimensions:
124.25" w x 83.51" h x 12.8" d
XCLM-6QP-K2

XCLAIM 14'W FULL HEIGHT KITS

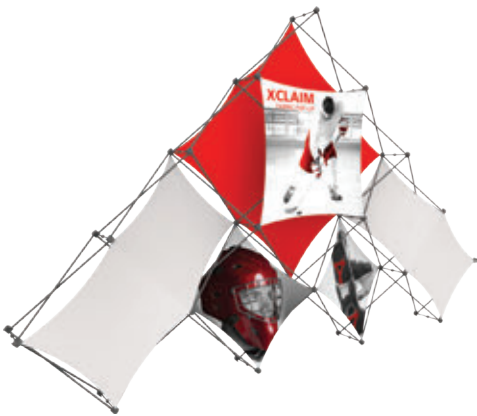

14' full height display
footprint dimensions:
164.99" w x 103.88" h x 12.8" d
XCLM-10QP-K1

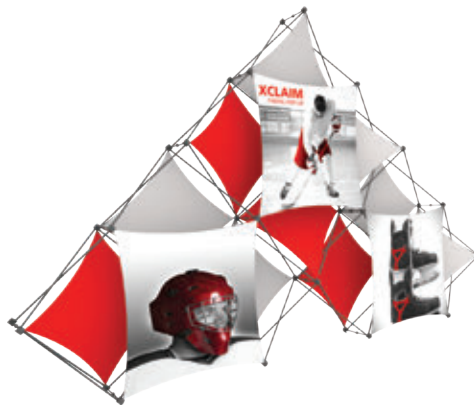

14' full height display
footprint dimensions:
164.99" w x 103.88" h x 12.8" d
XCLM-10QP-K2



14' full height display
footprint dimensions:
164.99" w x 103.88" h x 12.8" d
XCLM-10QP-K3



All Xclaim popups are eco-friendly and have a limited lifetime warranty.



RELIABLE.PORTABLE.ESSENTIAL. POPOP DISPLAY SYSTEMS

The Coyote™ popup display system combines reliability, portability and style • State-of-the-art rare earth neo magnets on individual channel bars make Coyotes fast and easy to popup and breakdown, especially when compared to complicated “snap in” channel bars and fragile locking style systems • All Coyote displays are offered in curved or straight systems, single or double sided • Option of combining either captivating graphic mural panels or versatile Velcro-friendly fabric panels



COYOTE™ POPUP DISPLAY SYSTEMS

This fully magnetic popup display system provides a graphic or Velcro receptive fabric backwall. Coyote™ popup displays require no tools for assembly, are portable, versatile, durable and easy to use. The Coyote line features a plethora of accessory options to add such as shelves, monitor mounts and case-to-counter conversion kits and graphics.



FABRIC CHOICES

All Coyote popup display systems are available with printed graphic murals or "Velcro-friendly" fabric panels of your choice. Actual fabric color may vary slightly.

regal - smooth exhibit & display fabric

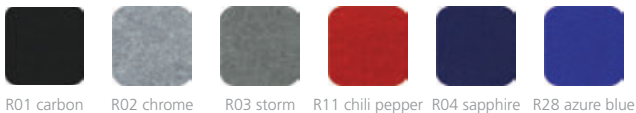

R01 carbon R02 chrome R03 storm R11 chili pepper R04 sapphire R28 azure blue

premier - ribbed exhibit & display fabric

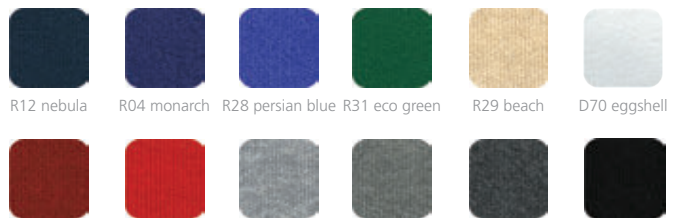

R12 nebula R04 monarch R28 persian blue R31 eco green R29 beach D70 eggshell

R30 maroon R11 electric red R02 steel R03 charcoal R15 cinder R01 lava



4' tabletop
footprint dimensions:
45.5" w x 30.63" h x 12.5" d
COY-KKG-1X1-C



6' tabletop
footprint dimensions:
73" w x 30.63" h x 19.25" d
COY-KKG-2X1-C



6' tabletop
footprint dimensions:
73" w x 59.38" h x 19.25" d
COY-KKG-2X2-C



8' tabletop
footprint dimensions:
97.25" w x 59.38" h x 25" d
COY-KKG-3X2-C

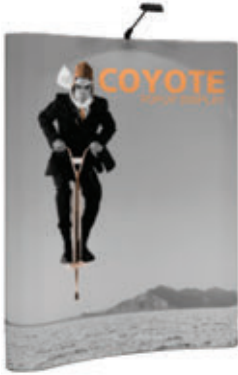

6' full height
slim-line display system
footprint dimensions:
73" w x 87.56" h x 19.25" d
COY-KKG-2X3-C



8' full height
standard display system
footprint dimensions:
97.25" w x 87.56" h x 25" d
COY-KKG-3X3-C



10' full height
standard display system
footprint dimensions:
118" w x 87.56" h x 36.5" d
COY-KKG-4X3-C



8' serpentine
full height display system
footprint dimensions:
102" w x 87.56" h x 20.25" d
COY-KKG-ST-8



11' serpentine
full height display system
footprint dimensions:
129" w x 87.56" h x 22" d
COY-KKG-ST-10



11' standard horseshoe
full height exhibit system
footprint dimensions:
113" w x 87.56" h x 54" d
COY-KKG-HS



17' deluxe horseshoe
full height exhibit system
footprint dimensions:
193.5" w x 87.56" h x 59.5" d
COY-KKG-DHS



20' gullwing
full height exhibit system
footprint dimensions:
231" w x 87.56" h x 41" d
COY-KKG-GW



20' serpentine
full height exhibit system
footprint dimensions:
217.75" w x 87.56" h x 60.5" d
COY-KKG-20



COYOTE™ MINI

- approx. 20% smaller than standard Coyote™ tabletops
- entire display rolls up into special storage sleeve which slides into a padded carry case
- kit includes frame, channel bars, front curved graphic panels, carry case & 2 lights
- add an optional OCS hard case for shipping or extra secure storage



6.5' mini tabletop kit
footprint dimensions:
77.5" w x 48.25" h x 16.25" d
COY-M-KKG-3X2-C

approx. 5' mini tabletop kit
footprint dimensions:
57.25" w x 48.25" h x 11.75" d
COY-M-KKG-2X2-C



easy rollup carry bag holds Coyote™ Mini hardware and graphics

BUBBLE PANEL

COY-K-GBBP-O

- forward facing, convex panel
- panel can be fabric, opaque graphic or rear illuminated graphic (light kit sold separately)
- hardware can be stored with display in case



MONITOR MOUNT

COY-MM

- fully integrates with straight or curved Coyote™ systems
- one panel cut to fit the monitor*
- VESA bolt compatible
- max weight = 50 lbs
- LCD max size = 23"



not recommended for plasma or CRT units

INTERNAL SHELF KIT

COY-IS-CK

- presents products or literature
- comes with 2 clear acrylic shelves to be used horizontally or at 45° angles
- max capacity per shelf = 15 lbs, max per quadrant = 45 lbs
- for use with curved frame only
- lighting package available (not to be stored with display)



COYOTE TOWER

COY-3-G-TOW

- an unexpected addition to any display; large or small, exhibit or P.O.P.
- back-lit panels illuminate your graphics (optional upgrade)
- coordinates with the look and style of your Coyote popup display



*Monitors not included.



All Coyotes come with a limited lifetime hardware warranty.

OCX CASE TO COUNTER CONVERSION



OCX

- premium latches for maximum strength
- blow molded transit case
- built in wheels, handle
- light storage in the lid
- UPS approved



Roll Wrap: OCX-C2C-G

- available in fabric or graphic
- converts OCX to a counter
- polymer counter surface exposed



Stretch Wrap: OCX-SW-G

- stretch fabric pullover
- converts OCX to a counter
- polymer counter surface covered by fabric

OCP-2 CASE TO COUNTER CONVERSION



OCP-2

- new premium latches for maximum strength
- hinged lid with internal light storage
- robust, roto-molded plastic



Roll Wrap: OCP2-C2C-G

- available in fabric or graphic
- converts OCP-2 to a counter
- polymer counter surface exposed



Stretch Wrap: OCP2-SW-G

- stretch fabric pullover
- converts OCP-2 to a counter
- counter surface covered by fabric

OCP ELITE CASE TO COUNTER CONVERSION



OCP-ELITE

- heavy-duty shipping and storage case
- lid can be used as a step stool
- access door provides storage when unit is used as a counter
- UPS approved



Roll Wrap: ELITE-C2C-G

- available in fabric or graphic
- converts OCP Elite to a counter
- counter surface exposed



Stretch Wrap: ELITE-SW-G

- stretch fabric pullover
- converts OCP Elite to a counter
- counter surface covered by fabric



BROWSE OUR FULL LINE OF FORMULATE **FABRIC** STRUCTURES IN THE MODULAR CATALOG



Formulate™ 10' Straight, p.100



Flip Kit 04, p.123



Formulate 10' Straight, p.100



Formulate C-Shaped Wall, p.154

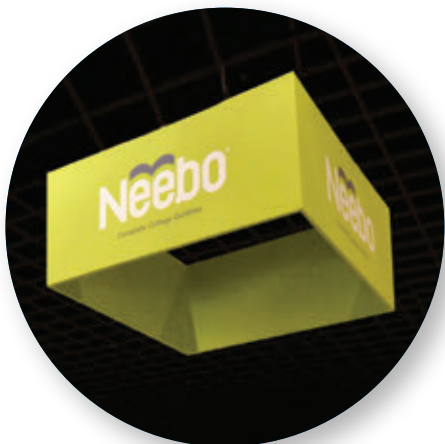

Formulate Square Hanging Structure, p.140



Formulate Fusion Kit 08, p.130



ADAPTABLE.FUNCTIONAL.PERFORMANCE. FOLDING DISPLAY PANELS

Premium portable folding panels provide a professional appearance without the fuss • Our variety of portable folding panels are superbly crafted with seamless panels made of ultra-light core material • Covered on both sides with polyester fabric, which come in a plethora of color choices and options • Use the Velcro-friendly panels as a way to feature your message or add optional detachable graphics

HERO™ DISPLAY PANELS

Hero™ panel displays are durable premium exhibit panel kits that feature the convenience of folding panels with elegant, seamless panel construction. Hero kits are available in a variety of fabric colors and feature concealed hinges with unique 2" radius curved ends to lend a polished appearance.



fits in an OCH case (case not included, see page 80)



shown with optional graphics
HERO H16

— 3'11" HIGH —
— 7'10" HIGH —

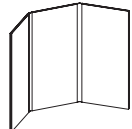

HERO H02-1
tabletop display

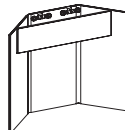

HERO H03
tabletop display with
backlit header

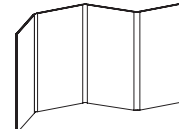

HERO H05
tabletop display

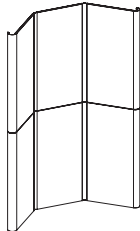

HERO H09
full height exhibit with
curved end caps

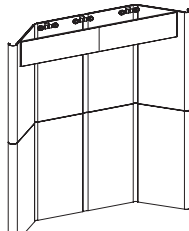

HERO H10
full height exhibit with curved
end caps and backlit header

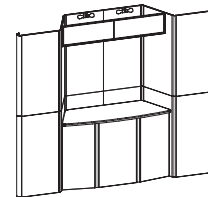

HERO H17
10' full height exhibit kit with
curved end caps & backlit header

For more styles, visit www.exhibitors-handbook.com

HORIZON™ DISPLAY PANELS

- main panel sizes approximately = 24" w x 36" h
- custom sized panel displays are available
- shown with optional detachable graphics
- available in a variety of fabric color options shown below



shown with premium printed table throw (page 35)



WEIGHS 12 LBS
Horizon 3
HZ-TT-S



WEIGHS 13.5 LBS
Horizon 5
HZ-TT-M



WEIGHS 22 LBS
Horizon 6
HZ-6



WEIGHS 31 LBS
Horizon 8
HZ-8

FABRIC CHOICES

All Horizon™ & Hero display systems are available with printed graphic murals or "Velcro-friendly" fabric panels of your choice. Actual fabric color may vary slightly.

regal - smooth exhibit & display fabric

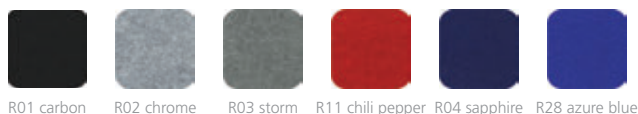

premier - ribbed exhibit & display fabric



VOYAGER™ FOLDING PANELS

The Voyager™ has been specially developed as a briefcase style tabletop display and is a great choice for promotions on the go. It has a rigid, thermo formed ABS exterior and a black, Velcro compatible fabric interior. Detachable graphics allow for easy message changes! Headers shown are an additional option. Extra graphics can be stored in the display case and packed away for easy storage.



WEIGHS 5 LBS VY-1

Voyager Mini kit (small)
open dimensions: 48" w x 18" h
closed dimensions: 24" w x 18" h



WEIGHS 6.5 LBS VY-2

Voyager Maxi kit (medium)
open dimensions: 48" w x 24" h
closed dimensions: 24" w x 24" h



WEIGHS 8.25 LBS VY-3

Voyager Mega kit (large)
open dimensions: 48" w x 32" h
closed dimensions: 24" w x 32" h



WEIGHS 8.25 LBS VY-4

Voyager Supreme kit (x-large)
open dimensions: 64" w x 24" h
closed dimensions: 32" w x 24" h



WEIGHS 10 LBS VY-5

Voyager Monster kit (xx-large)
open dimensions: 64" w x 32" h
closed dimensions: 32" w x 32" h



VOYAGER CARRY BAG



- Voyager Mini bag: VY-1-BG
- Voyager Maxi bag: VY-2-BG
- Voyager Mega bag: VY-3-BG
- Voyager Supreme bag: VY-4-BG
- Voyager Monster bag: VY-5-BG



VIEW OUR EXPANSIVE OPTIONS OF **MODULAR** EXHIBITS IN THE MODULAR CATALOG



Hybrid Pro™ Modular Kit 11, p.162



Vector Frame™ Light Box, p.172



Hybrid Pro Modular Kit 03, p.160



Hybrid Pro Modular Kit 01, p.160



Hybrid Pro Modular Kit 19, p.166



Hybrid Pro Modular Kit 17, p.164



FINAL.FUNDAMENTAL.FINESSE. ACCENTS & ACCESSORIES

Portable counters and kiosks provide ample storage and style to complement our vast array of 8', 10' and 20' exhibit kits and displays • Accent lighting kits and solutions help stage a powerful, impactful presence that you desire • Portable transit and shipping cases are designed to protect your exhibit investment • From sign stands and literature racks to poster frames and bag dispensers, a variety of display additions and accessories are at your fingertips



FREESTANDING TABLET STANDS

The freestanding iPad and Tablet Stands are smart, lightweight and portable and make it easy to incorporate media into any environment.

iPAD STAND

PAD12-02A-BLACK
PAD12-02A-SILVER
PAD12-02A-WHITE

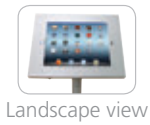

- displays iPad 2nd, 3rd, 4th gen and Air models*
- portrait or landscape
- security screws, allen key and bolts make the unit both durable and theft resistant
- base can be bolted to the floor for extra security
- offered in white, black and silver
- carry bag available as an upgrade



UNIVERSAL TABLET STAND

NEW

PAD21-04

- displays multiple tablet styles or iPad*
- portrait or landscape
- security screws, allen key and bolts make the unit both durable and theft resistant
- base can be bolted to the floor for extra security
- features a telescopic, adjustable-height pole, height minimum 28.88" - maximum 49.81" h



TENSION FABRIC iPAD STANDS

Are you looking to incorporate iPads into your display or environment? Sleekly-designed free standing iPad stands and kiosks make it easy to encourage interactivity, present information and engage your customers in any space. Stands feature stretch fabric graphics.



iPAD STAND 01
TABLET-STD-01



- 30" w x 84" h x 23" d
- small monitor mount*, holds 32" TV/32 lbs max
- iPad holder (2nd, 3rd, 4th gen and Air models)*
- pillowcase fabric graphic



iPAD STAND 02
TABLET-STD-02



- 20.25" w x 85.11" h x 23.8" d
- iPad holder (2nd, 3rd, 4th gen and Air models)*
- pillowcase fabric graphic



iPAD STAND 03
TABLET-STD-03



- 19.98" w x 64.34" h x 15.2" d
- iPad holder (2nd, 3rd, 4th gen and Air models)*
- pillowcase fabric graphic



iPAD STAND 04
TABLET-STD-04

NEW

- 26.26" w x 46.26" h x 22.64" d
- iPad holder (2nd, 3rd, 4th gen and Air models)*
- pillowcase fabric graphic

*Monitors and tablet devices not included.

LINEAR™ KIOSKS

Linear™ Monitor Kiosks add function and flare to any space. Extrusion based construction coupled with your choice of rigid graphic infill panels or frosted plex panels make these kiosks sturdy and versatile.



LINEAR KIOSK 01 LN-K-01

- 54.4" w x 99" h x 23.25" d
- monitor mount*
- fabric canopy
- approximate weight = 125 lbs



LINEAR KIOSK 05 LN-K-05

- 25.38" w x 72.25" h x 18.5" d
- monitor mount*
- approximate weight = 30 lbs



CHARGING STATIONS

Formulate™ Charging Stations add technology and great value for visitors in need of a quick charge. Excellent for retail applications, trade shows and events.



CHARGING TOWER FMLT-CHRG-01

- 33.56" w x 86.81" h x 33.46" d
- features 16 high-speed charging tips: (8) Micro USB for Android devices and (8) Apple 8-pin for Apple iPhone/iPad/Lightning devices
- features a circular fabric header for branding and an illuminated fabric center structure
- base and tabletop color offered in choice of four thermoform color options

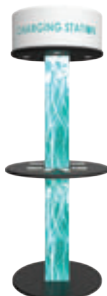

charging stations are available in your choice of finishes

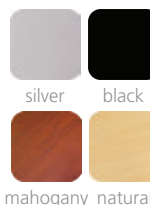

CHARGING COUNTER FMLT-CHRG-COUNTER-01

- 23.72" w x 41.54" h x 23.62" d
- features 8 high-speed charging tips: (4) Micro USB for Android devices and (4) Apple 8-pin for Apple iPhone/iPad/Lightning devices
- features stretch fabric graphic
- tabletop offered in choice of four thermoform color options



Top View



TENSION FABRIC COUNTERS

Add modern flare to your trade show exhibit, event or POP display with Formulate™ and Symphony™ fabric counters. With a variety of options to choose from, mix and match to create the ideal display or reception set up.



PILLAR
W-01-C 



HALF MOON
W-02-C



ELLIPSE 
W-03-C



BULLET
W-04-C



OVAL 
W-05-C



BAR 
W-06-C

SYMPHONY™ COUNTERS

Symphony™ counters provide a unique, sleek design that lends an attractive element to any trade show or POP display. Symphony counters combine extrusion-based hardware with state-of-the-art PRINTED or SOLID COLOR stretch fabric silicone edge fabric graphics (SEG).



OVAL
SYM-OV



RECTANGLE
SYM-RCT



BULLET
SYM-BLLT



OVAL DOUBLE GRAND
SYM-OV-DBL-GRND



3 QUAD KIT
SYM-QD-3

tension fabric counter tops are available in your choice of finishes



silver black mahogany natural

counter stretch skirts are available in custom printed options as well as the following colors:



amethyst ruby sapphire emerald silver jet

COUNTERS & KIOSKS



Counters and kiosks can be used to accessorize any trade show, event or permanent space. With a variety of different counters and kiosks to choose from, mix and match to create the best-suited display.

HOPUP™ COUNTER HOP-CT-2

- 41.75" w x 39.69" h x 14.25" d
- collapsible display counter
- Velcro applied fabric graphics
- includes clear internal shelf
- top available in four laminate finish options



EMBRACE™ COUNTER EMB-CT

- 40.95" w x 40.23" h x 14.95" d
- collapsible display counter
- includes clear internal shelf
- push-fit fabric graphics
- top available in four laminate finish options



Counter tops are available in your choice of four thermoform finishes



OCH2
wheeled
molded case
included
(page 80)



MONITOR KIOSK VB-MK-01

- medium monitor mount*
- max weight = 50 lbs
- comes with 1 OCH2 case
- *monitor not included



MONITOR KIOSK FREESTANDING-SPLIT-MM-KIT

- large monitor mount*
- max weight = 80 lbs
- OCFM case optional; ships freight
- *monitor not included

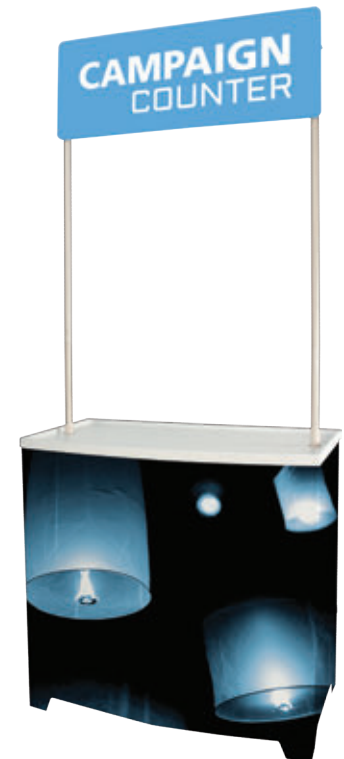

CAMPAIGN CP-B2

- counter dimensions not including canopy 32" w x 34.5" h x 18.5" d
- quick assembly
- strong & easy to clean plastic parts



*Monitors not included.



SIGN STANDS

Easily display a graphic or message with a versatile and easy-to-assemble sign stand. We offer stands that feature adjustable posts, portrait and landscape sign configurations and more.



SPARTAN
SPARTAN

- 52.75" h
- sleek, sign holder features acrylic pocket to hold 8.5" w x 11" h literature
- silver aluminum alloy post and circular black base
- add second post to hold a larger rigid graphic



OBSERVE PRO
OBS-LP-SYS

- 48" h
- lightweight, snap-together info center with 12" dia. base
- stylish curved header & adjustable brochure holder
- accepts 8.5" w x 11" h literature & graphic



OBSERVE DELUXE
OBS-DLX

- 74.5" h
- stylish double sided curved design
- holds two 24" w x 36" h bubble graphics
- recommended printing material: .040"-.125"
- elegant brushed silver
- sturdy steel base with removable and adjustable brochure pockets



OBSERVE GRAND
OBS-B

- 68" h
- sleek info center includes sturdy base & adjustable shelf
- accepts 22.88" w x 27.5" h graphic size
- single or double sided
- holds a 3/16" thick mounted graphic



ACCLAIM
ACCLAIM

- telescopic post offers variable height from 37" - 54.5"
- modern aluminum swiveling sign holder holds rigid 17" w x 11" h graphic
- brushed silver holder, post and square base



ADVOCATE
ADVOCATE

- telescopic post offers variable height from 30.5" - 48"
- aluminum sign holder holds 8.5" w x 11" h paper
- frame can be rotated 360 degrees or any desired angle
- chrome finish



SNAPPER STAND
SNP-STAND

- 40" h
- stylish, easy snap-open 11" w x 17" h frame
- frame can be used in portrait and landscape configurations
- silver aluminum sign holder, post and base



ACCOLADE
ACCOLADE

- telescopic post offers variable heights from 33" - 51"
- bamboo sign holder holds 8.5" w x 11" h paper
- frame can be used in portrait and landscape configurations
- comes with canvas carry bag

SIGN STANDS



Easily display a graphic or message with a versatile and easy-to-assemble sign stand. We offer stands that feature adjustable posts, portrait and landscape sign configurations and more.

TRAPPA POST

- versatile Trappa Posts feature snap sign frames & come in a variety of configurations and sizes
- sturdy aluminum posts and heavy domed steel plate ensure stability
- choice of silver or black snap frames, large or small, landscape, portrait or diagonal
- front loading graphic mechanism makes graphic changes easy
- includes clear protective lenses

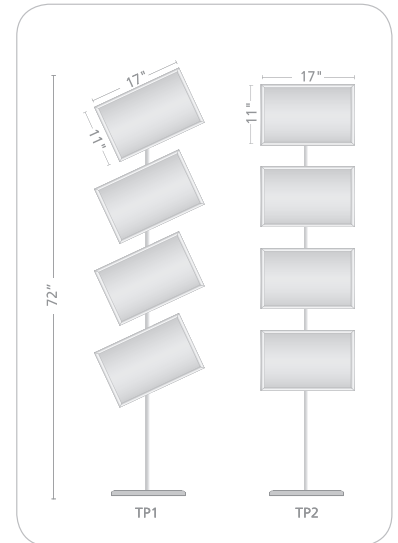
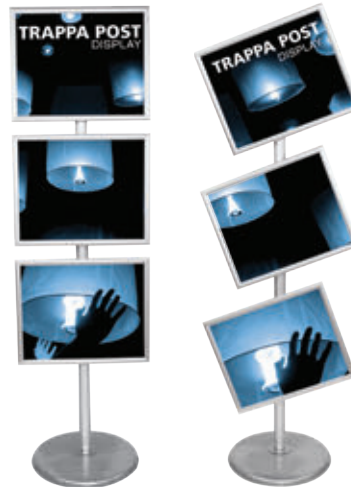

TOWERS

Maximize your messaging in any lobby, entryway, at any event or tradeshow with a versatile display tower. From configurable to illuminated features, you are sure to find a tower that suits your messaging needs.

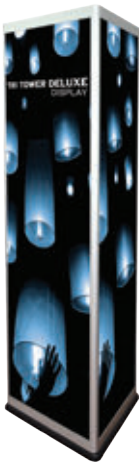

TRI-TOWER DELUXE TRI-TOWER-DLX

- 26.75" w x 72" h free-standing modern-looking triangular display
- durable aluminum extrusion construction coupled with rigid graphic infill panels
- convenient sliding cam locks make graphic changes quick and easy
- heavy-duty laminated foot plate
- simple assembly
- optional lighting kit available



BACKLIT TOWER

- collapsible double sided free-standing towers
- just add the optional lighting kit and turn your tower into a free-standing lightbox!
- 24" or 33" w x 72" h "bubble" panels for maximum visibility
- recommended printing material: .040"-.125"
- your choice of silver or black aluminum edge extrusions
- black laminate top & bottom plates

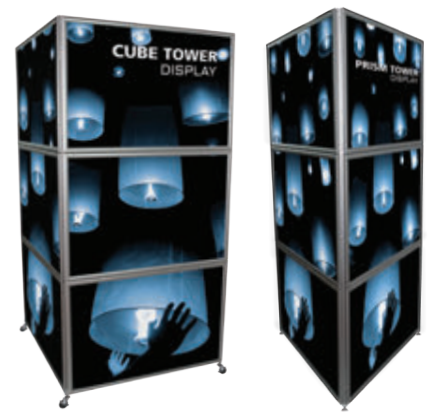

CUBE TOWER PRISM TOWER

- easy-to-use snap frames featured on all sides
- variety of configurations and sizes available
- choice of silver or black snap frames
- seamlessly display multiple graphics and messages
- front loading graphic mechanism makes graphic changes easy
- frames come with clear protective lenses
- options include wheels or feet
- custom sizes also available

LITERATURE RACKS

Literature racks are used to simply display brochures and can be used in countless applications, from trade shows, conference rooms and events to lobbies and more.



ZEDUP 1

black: ZD-1-B
silver: ZD-1-S

- 6 pocket rack
- can be stored or shipped loaded with literature



hard case upgrade:
black: ZD-1HC-B
silver: ZD-1HC-S



ILLUSION

black: IL-1-B
silver: IL-1-S

- fast-folding cantilever rack
- 4 front facing pockets



ZEDUP LITE

silver: ZD-LITE

- 6 pocket rack
- collapsible
- lightweight version of the ZedUp
- constructed from aluminum & plastic for reduced weight



DEMONSTRATOR

DEMONSTRATOR

- 45" h
- stylish acrylic sign holder holds literature in top and bottom pockets
- top frame can be used in landscape configuration only
- acrylic sign holders, brushed silver post and base



INNOVATE

black: INN-B
silver: INN-S

- modular design
- 10 pockets
- packs in 3 separate parts for reduced shipping size



VICTORY

VIC-S

- slim, modular, snap-together design



10 UP

black: 10UP-B

- strong & stable
- 10 pockets
- packs flat

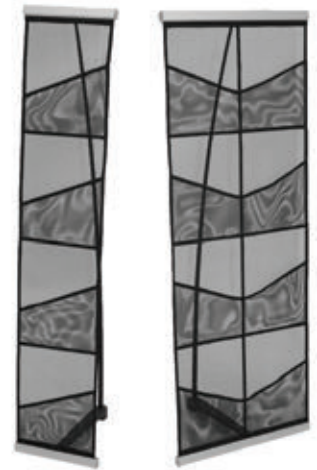

LR 1 & LR 2

4 pocket: LR-1
8 pocket: LR-2

- modular, roll-up mesh design
- holds standard 8.5" w x 11" h literature
- 4 or 8 pocket model
- black with chrome accent



All literature racks come with a five year limited warranty, a carry bag, and are an eco-friendly choice.

SNAP FRAMES



Snap Frame LED Light Boxes feature an edge-lit LED diffuser panel, a thin 1" profile and easy-to-use snap frames. The LED diffuser panel ensures even light distribution and brightness. Silver frames snap open from the front to allow quick and easy graphic changes. No tools are required. Comes standard with clear protective lenses, fully assembled and ready to hang. Snap Frame LED Light Boxes are ideal for permanent retail displays, corporate environments, eye-catching tradeshow graphics and more.

TRAPPA LIGHTBOX



- only 1" thick (single sided only version offered)
- 50,000 hr bulb life
- evenly distributed light
- snap frames allow easy graphic changes
- wall mounting hardware
- power supply with 78" cord

AVAILABLE SIZES:

- LED-SNAP-01: 16" x 20"
- LED-SNAP-02: 22" x 28"
- LED-SNAP-03: 24" x 36"
- LED-SNAP-04: 30" x 40"
- LED-SNAP-05: 36" x 48"



TRAPPA POSTER FRAME



- black or silver anodized finish with precision mitered corners
- spring loaded aluminum extrusions mounted to a high-impact polystyrene backer
- trappa frame edges snap open from the front to allow quick and easy graphic changes with no tools required
- available in a wide range of standard sizes & includes a clear anti-glare lens



POSTER SNAPPER



- adjustable hanging clips slide along the top rail to match desired spacing
- hanging clips feature both top opening for clear nylon line mount, and recessed pocket for S-hook suspension
- rails snap open and shut for quick graphic changes
- clean, simple, elegant look
- comes in 4 different standard widths: 24", 30", 36", 48"
- custom cut width available up to 60"





DISPLAY ADDITIONS

From sign stands to poster frames, towers, bag dispensers and more, display accessories and accents are designed to help add the final touches, function and flare to any display or space.

APEX

APEX



- double sided plastic a-frame
- can be printed directly on the plastic for a smooth look
- for indoor or outdoor use



WEDGE

WED-1-B



- combine multiple units for longer and taller displays
- graphic size is variable
- black only
- graphics not included

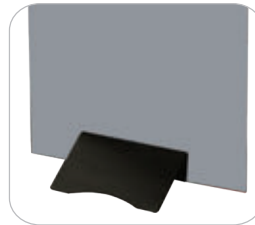

AMBASSADOR

AMBASSADOR



- magnetic name badge
- 2.94" w x 1.25" h
- silver finish



OASIS

OASIS



- highly portable
- three arm collapsible bag dispenser
- shiny silver finish



STEP STOOL

STEP STOOL-BLUE



- sturdy EZ FOLDZ step stool
- 300 lb capacity
- folds flat for storage & transport
- blue only



SLIMLINE LED LIGHTING

Incorporate modern, bright LED lights into your display and draw attention to your brand and message with elegance. With bright, cool lights and contemporary slim profiles, you can modernize your display, set the stage and better communicating a clear message. Choose from several LED lighting solutions that will make your message and products shine.



NEW

LED FLOOD LUM-LED4-ORL-B

- low voltage 12 watt spotlight
- 17.16" long from end to end
- mounts to dovetails and extrusion channel
- available in black only



NEW

LED SPOT LUM-LED3-ORL-B

- low voltage 5 watt slender spotlight
- 17.18" long from end to end
- mounts to banner stands
- available in black only

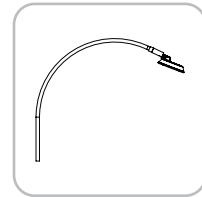

NEW

LED STRIP LUM-LED5-ORL-B

- low voltage 12 watt
- 16.1" long from end to end
- mounts to dovetails and extrusion channel
- available in black only

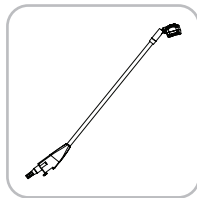

NEW

LED EXHIBITION LUM-LED6-ORL-B

- low voltage 12 watt spotlight
- 17.13" long from end to end
- mounts to extrusion channels
- available in black only

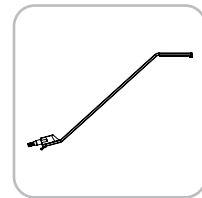

LUMINA 200 LED

black: LUM-LED2-ORL-B
silver: LUM-LED2-ORL-S

- LED Lumina 200 floodlight
- Uses multi cups chip on board (MCOB) light technology and features a slim profile
- LED rated for 20,000 continuous hours
- 19" long from end to end

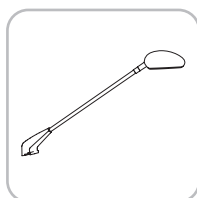

LIGHTING IS AN IMPORTANT ELEMENT TO ANY DISPLAY



LIGHTING DRAWS ATTENTION TO YOUR BRAND AND MESSAGE WITH ELEGANCE.



LUMINOSITY™ DISPLAY LIGHTING

Lighting can create a powerful, impactful presence or display. Illumination is an important piece of the puzzle to achieve the mood, style and staging that you desire. A variety of Luminosity™ display lights, lighting kits and solutions are available to help clients make their projects shine!



LUMINA 1

black: LUM-1-B
chrome: LUM-1-C

- low voltage 50 watt spotlight & universal fittings kit
- "goose neck" arm
- mounts horizontally
- LED option available

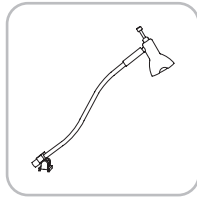

LUMINA 2

LUM-2-1

- low voltage 50 watt slender banner stand spotlight
- mounts to a vertical pole
- brushed stainless steel finish
- LED option available

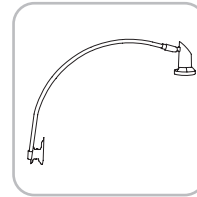

LUMINA 5

LUM-5

- low voltage 50 watt spotlight & universal fittings kit
- deluxe chrome head
- telescopic arm
- extends from 7" - 22" long
- LED option available

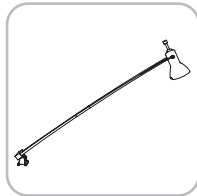

LUMINA 6

LUM-6

- low voltage, 50 watt spotlight & universal fittings kit
- stylish curved twin arms
- silk black only
- LED option available

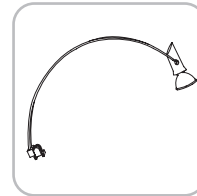

LUMINA 8

black: LUM-8-B
silver: LUM-8-C

- 12 volt spotlight with straight arm & adjustable head
- includes 110 volt UL approved transformer, 50 watt bulb & universal fittings kit
- 17" long from end to end
- LED option available

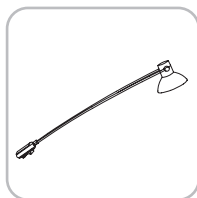

LUMINA 200 FLOODLIGHT

LUM-200-ORL

- 110 volt ETL approved wall washer floodlight with a straight arm & adjustable head
- light includes 120 watt halogen bulb
- 19.5" long from end to end
- silk black finish

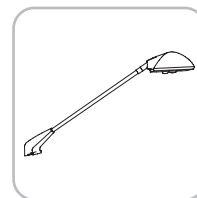

UNIVERSAL LIGHT CLAMP KIT

UNI-LT-CLP30
UNI-LT-CLP50

- comes standard with the Lumina 1, 5, 6, 8 and allows our lights to fit a majority of banners, truss & panel kits



SPT CASE

SPT-CASE

- EVA semi-rigid lighting case
- foam-lined padded compartments
- holds two Lumina 200 lights & power supply
- fits Lumina 1, 2, 5, 6, 8 and power supply



LED BULB OPTION

LUM-LV-LED-BLB16

- a green solution for Lumina 1, 2, 5, 6, 8
- 50 watt equivalent LED bulb



LUMINA SPARE BULB KIT

LUM-BULB

- (2) 50 watt low voltage spare bulbs in a padded, protective EVA formed case



FLOODLIGHTS & WALL WASHERS

LED FLOOD LIGHT

LED-FLOOD

- 85-265 voltage, 42 watt LED Flood light (equivalent to 400 watt halogen)
- projects cool WHITE light
- 7.4" w x 9.44" l x 5.11" d
- angles to 120°
- UL approved



MINI LED FLOOD LIGHT

LED-10W-FLOOD-RGB

LED-10W-FLOOD-W

- 10 watt LED Flood light
- projects cool WHITE or RGB spectrum light
- remote control provided with RGB version
- each light measures 4.49" w x 3.39" h x 3.98" d
- angles to 120°
- UL approved



COLOR BLAST ACCENT LIGHTS

- 85-265 voltage, 13 watt LED blast light
- projects your choice of warm or cool WHITE, and a RGB spectrum flashing pattern
- 7" round x 7" h (when faceplate is flush with base and not angled)
- angles to 60°
- UL approved



LED-WRM-WHT-BLAST
Features a warm white LED light output; good for light-colored and neutral graphic prints. 3,000K



LED-COOL-WHT-BLAST
Features a cool LED light output; good for darker graphic prints. 6,000K



LED-RGB-BLAST
Features multi-pattern flashing RGB LED light output; RGB spectrum cannot be controlled.

It's critical to protect your tradeshow exhibit investment with a quality constructed transit and shipping case. An extensive selection of exhibit and display cases and crates to choose from that are all made in the USA and are designed to house specific lines of exhibits and displays for maximum portability and protection during shipping.

LIGHTING & ACCESSORY CASE

OCA-2

- ideal for lights and accessories
- secure straps help to ensure case will remain closed during transport
- interior size:
32.81" w x 4.13" h x 13.75" d
- exterior size:
34" w x 7" h x 15" d
- weight when empty: 8 lbs



SMALL & LARGE GRAPHIC CASES

small: OCS

large: OCL

- premium latches for maximum strength
- built in wheels and easy-to-grip molded handle

OCS

- interior size:
14" w x 39.13" h x 13.25" d
- exterior size:
18" w x 42.25" h x 16.5" d
- weight when empty: 18 lbs

OCL

- interior size:
14" w x 51.5" h x 13.25" d
- exterior size:
18" w x 55.13" h x 16.5" d
- weight when empty: 20 lbs



BANNER STAND CASE

OCB

- this expandable shipping case fits up to three swivel-foot banner stands with bags or one premium stand with bag*
- also used for Formulate™ Lite displays
- interior size min/max:
min - 12" w x 30.13" h x 3.75" d
max - 12" w x 47.13" h x 3.75" d
- exterior size:
min - 14.56" w x 30.38" h x 5.88" d
max - 14.56" w x 47.38" h x 5.88" d
- weight when empty: 9 lbs
- *case does not fit Uno, Spring 5, Contender 48 or banners over 39.37" wide



EXPANDABLE CASE

OCE

- the perfect protective shipping and/or storage case for all Formulate™ exhibit kits, hanging structures and accessory products
- adjustable roto-molded expandable display case
- adjustable lid and easy pin latch
- interior size min/max:
min - 13.75" w x 39.63" h x 11.75" d
max - 13.75" w x 64" h x 11.75" d
- exterior size min/max:
min - 16.75" w x 39.88" h x 16.88" d
max - 16.75" w x 64.25" h x 16.88" d
- weight when empty: 27 lbs
- separate fabric graphic converts the case into a counter



All cases come with a one year limited warranty, are an economic & eco-friendly choice & made in the USA. Shipping dimensions may vary.

STANDARD WHEELED DISPLAY CASE

OCX

- light storage in the lid
- premium latches for maximum strength
- interior size:
23.5" w x 35.75" h x 13.07" d
- exterior size:
26.73" w x 39.49" h x 17.05" d
- weight when empty: 31 lbs



PREMIUM WHEELED DISPLAY CASE

OCP-2

- premium latches for maximum strength
- hinged lid with internal light storage
- robust, roto-molded plastic
- interior size:
22" w x 35.5" h x 14.13" d
- exterior size:
26" w x 39.56" h x 17.75" d
- approximate weight when empty: 32 lbs



DELUXE WHEELED DISPLAY CASE

OCP-ELITE

- lid can be used as a step stool while assembling displays
- access door provides storage when unit is used as a counter
- interior size:
14.13" w x 31.75" h x 19.75" d
- exterior size:
16.75" w x 38.25" h x 26.25" d
- weight when empty: 31 lbs



HOPUP/MEDIUM WHEELED CASE

OC-HOP

- ideal for Hopup backwall displays (fits up to 4x3 hopup)
- built-in handle and wheels for easy transport
- interior size:
13.5" w x 35.5" h x 13.5" d
- exterior size:
15.5" w x 35.69" h x 17" d
- weight when empty: 17 lbs



LARGE DISPLAY CASE

OCH

- roto-molded case for exhibits, graphics & accessories
- secure reinforced straps help to ensure case will remain closed during transport
- strong yet lightweight
- interior size:
23.25" w x 7.63" h x 46.5" d
- exterior size:
26" w x 12" h x 50" d
- weight when empty: 22 lbs



LARGE DISPLAY CASE

OCH2

- heavy-duty shipping and storage case
- ideal for Linear hybrid displays
- secure reinforced straps help to ensure case will remain closed during transport
- interior size:
24.13" w x 12.25" h x 47.25" d
- exterior size:
29" w x 15" h x 52" d
- weight when empty: 30 lbs
- wheels and handles recessed



All cases come with a one year limited warranty, are an economic & eco-friendly choice & made in the USA. Shipping dimensions may vary.

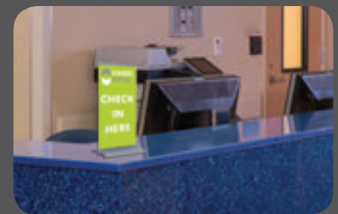
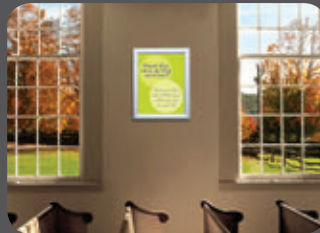
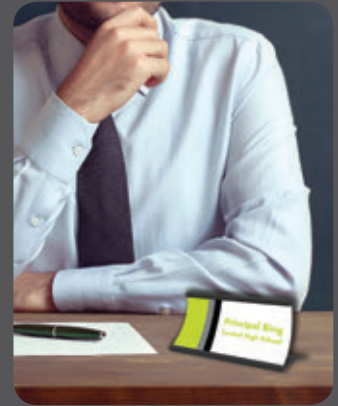
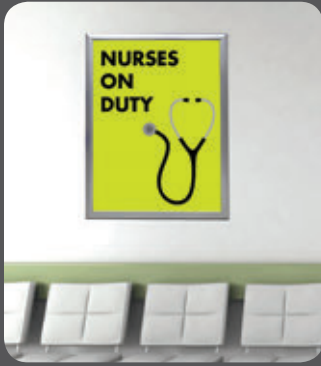

Wayfinding 101: Directional Signage Solutions

THE SIGN MAKERS™
HANDBOOK
WAYFINDING SYSTEMS

www.signmakers-handbook.com



FABRIC DISPLAYS & STRUCTURES

88 | FORMULATE™ ESSENTIAL

BANNERS | TABLETOP DISPLAYS | 8' DISPLAYS | 10' DISPLAYS



93 | FORMULATE MASTER

TABLETOP DISPLAYS | 10' DISPLAYS | 20' DISPLAYS | ACCENTS



110 | FORMULATE DESIGNER SERIES

10' DISPLAYS | 20' DISPLAYS | 30' DISPLAYS



124 | FORMULATE FUSION 20' X 20' ISLAND KITS



136 | FORMULATE HANGING STRUCTURES



146 | FORMULATE ARCHITECTURAL STRUCTURES

FUNNELS | COLUMNS | TOWERS | ARCHES | CONFERENCE WALLS

SYMBOLS USED:



product made in the USA



economy product



standard product



premium product



product can be recycled (does not include graphic application)



product comes with a carry bag or case



rental product



new product

MODULAR EXHIBIT SYSTEMS

HYBRID PRO™ MODULAR DISPLAYS | 156

10' DISPLAYS | 20' DISPLAYS | ISLANDS



VECTOR FRAME™ MODULAR DISPLAYS | 168

BANNER DISPLAYS | 10' DISPLAYS | 20' DISPLAYS | ACCENTS



LINEAR™ PRO MODULAR DISPLAYS | 182

10' DISPLAYS | 20' DISPLAYS | ACCENTS



MERCHANDISE EXPRESS™ MODULAR DISPLAYS | 186



ORBITAL EXPRESS™ TRUSS MODULAR DISPLAYS | 190

10' DISPLAYS | 20' DISPLAYS | ISLANDS | ACCENTS

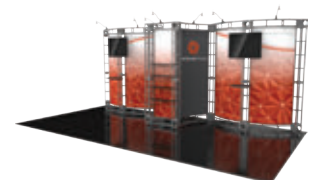

ACCENTS & ACCESSORIES | 214

AERO | COUNTERS | LIGHTS | CASES



WARRANTY KEY:



lifetime limited warranty (hardware)



5 year limited warranty (hardware)



1 year limited warranty (hardware)



90 day limited warranty (hardware)



graphics limited 1 year warranty (indoor products)



graphics limited 6 month warranty (outdoor & table throw products)

FORMULATE **FABRIC** STRUCTURES

From straight and angular shapes to ergonomic, flowing forms the Formulate™ line of fabric exhibits and structures encompasses a full spectrum of beautiful fabric-based exhibits, environments and structures, off-the-shelf to custom. Formulate fabric structures and solutions combine shape, specialty fabrics, lightweight frames and lighting to create captivating and artistic presentations and spaces.

Shapes to mix & match...

Formulate's off-the-shelf fabric structures couple lightweight aluminum tube frames with stretch, zipper pillowcase fabric graphics. Formulate fabric structures are formed with expert aluminum bending machinery and skilled welding and metal-working technicians. We offer a complete line of fabric backwalls, exhibit kits, hanging shapes and structures, towers, archways, walls, rooms and more.

Off-the-shelf display systems and architectural structures include:

- Formulate inline tension fabric displays
- Formulate counters, kiosks, iPad stands & accessories
- Formulate hanging structures
- Formulate towers, funnels & arches
- Formulate Fusion island exhibits, conference rooms & more

With the endless off-the-shelf and customized options Formulate provides, you can mix and match to create the ideal display, booth or environment.

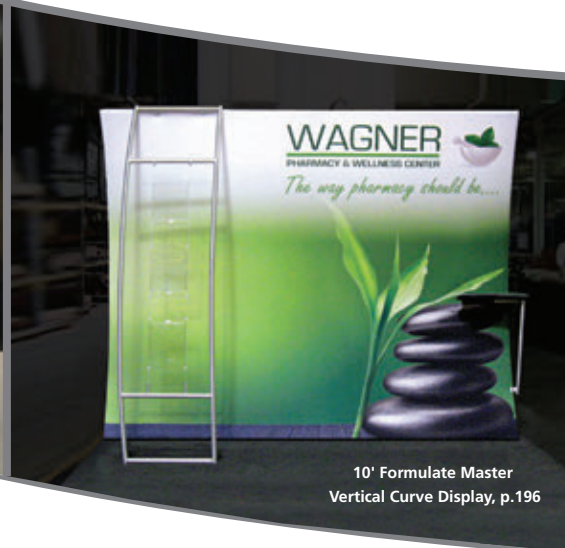

MODULAR **EXHIBIT** SYSTEMS

Modular exhibit systems and displays provide exhibitors with sophisticated, custom-looking exhibits that stand the test of time and can adapt and evolve from show to show. Using standardized components as building blocks, modular displays can often be reconfigured to fit multiple size spaces and customized to fit unique needs.

Modular exhibits are smart, versatile and often feature recyclable aluminum components that support longevity and reusability.

Our modular exhibit systems are created by expert welding and metal-working technicians. With the latest state-of-the-art printing technology and large format printing capabilities, we ensure your desired message stands out from the competition; graphics are produced and finished by hand by highly-skilled sewers in the USA.

Off-the-shelf modular exhibit systems include:

- Hybrid Pro™ Modular inline & island exhibit kits & counters
- Vector Frame™ banners, light boxes, exhibit kits, kiosks & counters
- Linear™ Pro modular inline exhibit kits, kiosks and counters
- Merchandise Express™ portable point-of-purchase displays
- Orbital Express™ Truss modular inline & island exhibit kits, counters, kiosks & accessories
- Aero portable modular display system

With such an expansive range of off-the-shelf modular exhibit systems to choose from, you can easily create an impactful, versatile exhibit that will evolve with your exhibiting needs and demands over time.

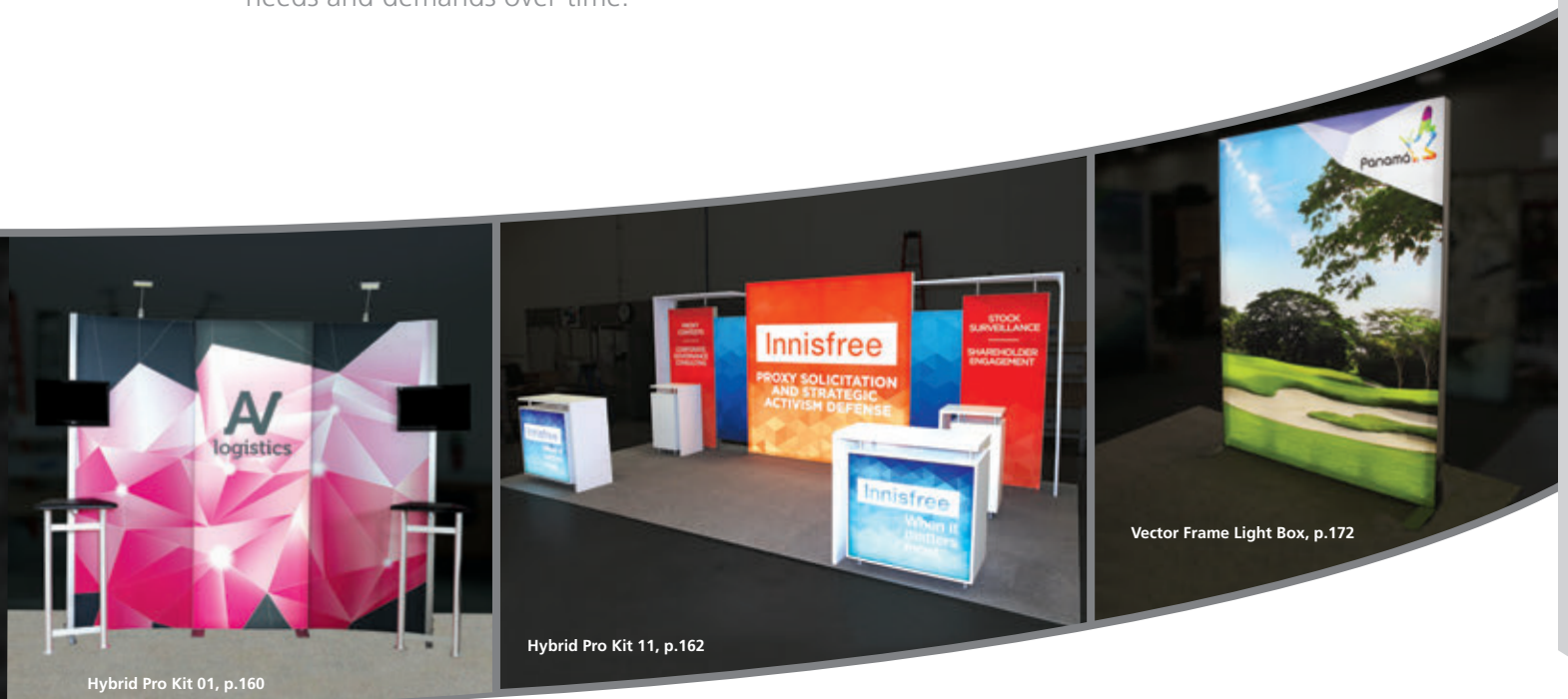

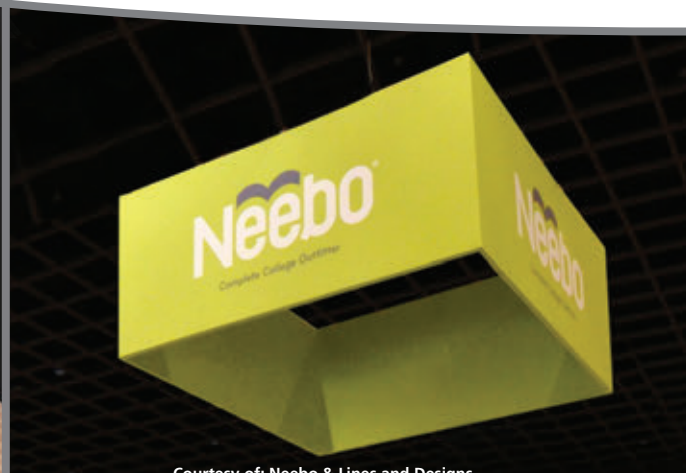

FORMULATE **FABRIC** STRUCTURES

The Formulate™ line spans from a collection of portable, off-the-shelf exhibit kits, hanging structures and architectural accessories to custom-designed and built exhibits, environments and interior display solutions. Formulate combines state-of-the-art zipper pillowcase dye-sublimated fabric coverings with advanced lightweight aluminum tube structures to provide elegance, functionality and style.

The quality of the Formulate line is excellent. The perfect combination of form, sophistication and function make Formulate displays the ideal solution for any space. All Formulate stretch fabric graphics are made in the USA, printed on state-of-the-art, G7 color certified printers and are hand-sewn, durable and dry-cleanable.

The Formulate line includes tabletop, 8', 10', 20' and 30' backwalls and exhibit kits, 20' x 20' island exhibit kits, hanging structures, towers, columns, funnels, archways, counters and more. Easily mix and match to create your ideal display, exhibit or environment or work with us to create a custom solution from scratch.

NO MATTER WHAT YOUR SPACE NEEDS,
WE CAN **FORM** A SOLUTION FOR YOU.





Formulate™ Essential banner displays feature basic tubular frames coupled with pillowcase fabric graphics. The economy tube frames come with a one year limited warranty. Simply pull the graphic over the frame.

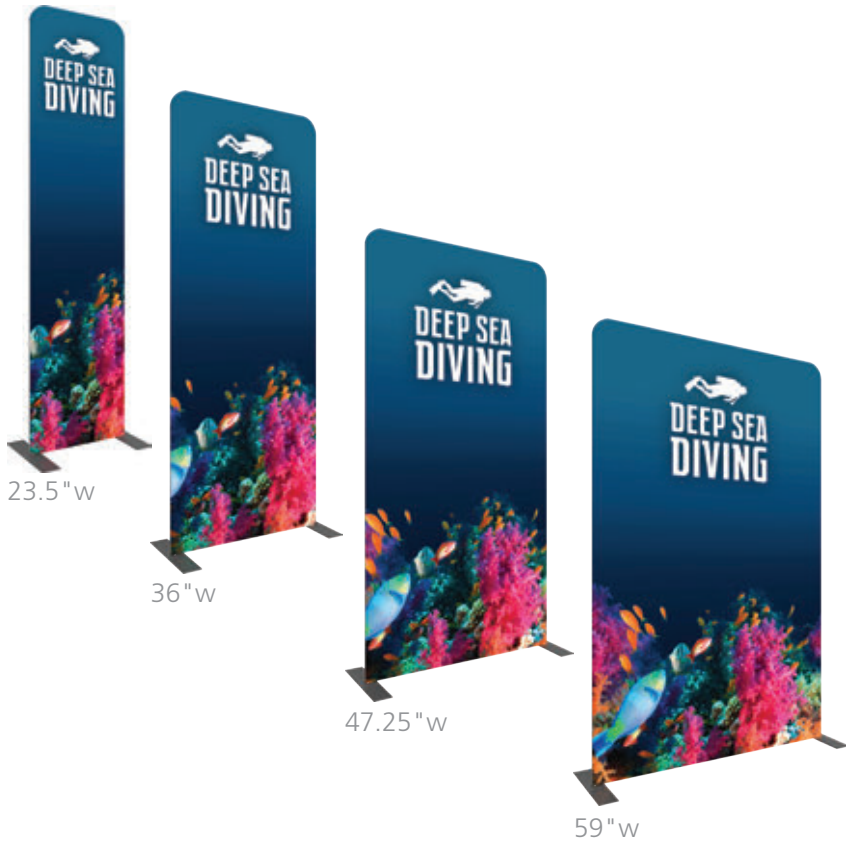

FORMULATE ESSENTIAL BANNER – STRAIGHT

- 23.5" WIDE** FMLT-ESS-S-600
- 36" WIDE** FMLT-ESS-S-920
- 47.25" WIDE** FMLT-ESS-S-1200
- 59" WIDE** FMLT-ESS-S-1500

- standard graphic height = 92"
- standard depth = 17.72"
- straight aluminum tube frame
- rounded corners
- bungee cords for easy assembly
- sturdy feet anchor the display
- pillowcase fabric graphic
- comes with carry bag



FORMULATE ESSENTIAL BANNER – CURVED

- 23.5" WIDE** FMLT-ESS-C-600
- 36" WIDE** FMLT-ESS-C-920
- 47.25" WIDE** FMLT-ESS-C-1200
- 59" WIDE** FMLT-ESS-C-1500

- standard graphic height = 92"
- standard depth = 23.96"
- curved aluminum tube frame
- rounded corners
- bungee cords for easy assembly
- sturdy feet anchor the display
- pillowcase fabric graphic
- comes with carry bag



COBRA
FMLT-ESS-COBRA

36.25" w x 89.5" h x 34.5" d
The Cobra is a single or double sided fabric banner stand. Simply connect the basic lightweight aluminum tube frame, slip the fabric graphic on and you have a sleek serpentine-curved banner stand in minutes. Includes a canvas carry bag.



ENTICE
FMLT-ESS-ENTICE-01
FMLT-ESS-ENTICE-02

31.5" w x 89.5" h - 99.13" h x 17.88" d
Entice is a double sided tension fabric display stand that features a small, clear, acrylic shelf. Entice is offered with a curved or sloped top and allows you to dress up any space with your own graphic. Entice comes with a canvas over-the-shoulder carry bag. Shelf spans 34.5" w and is 6.25" deep, and can hold a maximum of 15 lbs.



SHARK FIN
SHARK-FIN

70" w x 86" h x 17.7" d
The Formulate™ Shark Fin is an ideal banner for any indoor event. Simply slip the fabric graphic over the frame and you have an instant display. Includes a wheeled, molded storage case (OCB).



easy to apply
pillowcase
fabric graphics



bungee corded
poles allow for
simple assembly*

*select Formulate banners feature bungee cords



FORMULATE FABRIC BANNER
FMLT-WV03-01

36" w x 92.7" h x 24" d
A sophisticated display for any space, the Formulate Vertical Curve fabric banner combines a lightweight aluminum frame with a zipper-pillowcase graphic. Includes a wheeled, molded storage case (OCL).



Formulate Essential displays are portable and come with a one year limited hardware warranty.

formulate™ essential | TABLETOP & 8' DISPLAYS

FORMULATE ESSENTIAL TABLETOP DISPLAYS

Formulate™ Essential Tabletop displays have customary frame features, are portable and come in Straight, Vertical Curved and Horizontal Curved options. The economy aluminum tube frame features bungee cords, rounded corners and comes with a one year limited warranty. Simply pull the pillowcase fabric graphic over the frame and zip. All displays have an overall height of 5' and fit on an 8' wide table and come with a canvas carry bag.



Vertical Curved
FMLT-ESS-VTT-01



Straight
FMLT-ESS-STT-01



Horizontal Curved
FMLT-ESS-HTT-01

FORMULATE ESSENTIALS 8' DISPLAYS

Formulate™ Essential 8' displays have customary frame features, are portable and come in Straight, Vertical Curved and Horizontal Curved options. The economy aluminum tube frame features bungee cords, rounded corners and comes with a one year limited warranty. Simply pull the pillowcase fabric graphic over the frame and zip. All displays come with a canvas carry bag.



Straight
FMLT-ESS-S08-01



Horizontal Curved
FMLT-ESS-H08-01



Vertical Curved
FMLT-ESS-V08-01

10' DISPLAYS | formulate™ essential

FORMULATE ESSENTIAL 10' DISPLAYS

Formulate™ Essential 10' displays have customary frame features, are portable and come in Straight, Vertical Curved, Horizontal Curved and Serpentine Curved options. The economy aluminum tube frame features bungee cords, rounded corners and comes with a one year limited warranty. Simply pull the pillowcase fabric graphic over the frame and zip. All displays come with a canvas carry bag.



Vertical Curved
FMLT-ESS-V10-01



Straight
FMLT-ESS-S10-01



Horizontal Curved
FMLT-ESS-H10-01



Serpentine Curved
FMLT-ESS-SC10-01



Formulate Essential displays come with a carry bag and a one year limited hardware warranty.

formulate™ lite | 8' & 10' DISPLAYS

FORMULATE LITE 8'/10' DISPLAYS

Looking for a sharp, simple, portable fabric backwall that sets up in 5 minutes or less? Look no further. The Formulate™ Lite 8' x 10' fabric backdrop is one of the fastest and easiest solutions you can find. In addition to the standard landscape/horizontal configuration, Formulate Lite can be turned on its side to create a portrait/vertical wall as well.

The sturdy, lightweight 30mm aluminum frame assembles with simple push-buttons. Simply stretch the graphic over the corners of the frame and you're done. You have an instant, impressive fabric backwall!

The Formulate Lite kit is supplied in a carry bag. Shown with an optional, upgraded OCB case.

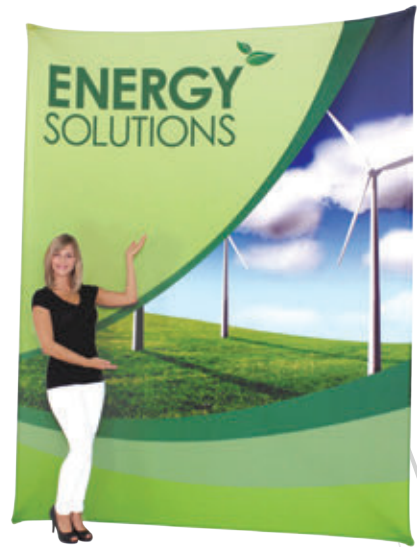

Formulate Lite - portrait/vertical graphic
FMLT-LT-01



Formulate Lite -
landscape/horizontal graphic



FORMULATE MASTER 8' DISPLAYS

Simplicity and style make Formulate™ Master 8' displays an ideal solution. Available in Straight, Vertical Curved and Horizontal Curved options, Formulate Master 8' displays are easy-to-assemble with snap-buttons and pull-over zipper pillowcase fabric graphics. All displays come in a portable, wheeled transit case.



Formulate 8H
FMLT-WH8-01



Formulate 8S
FMLT-WS8-01

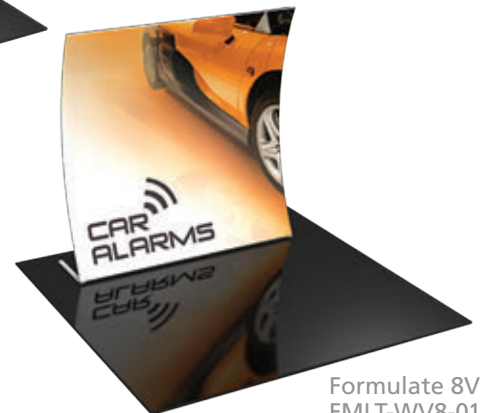

Formulate 8V
FMLT-WV8-01



Formulate TT1
FMLT-WTT-V01

**FORMULATE
TABLETOP DISPLAYS**

Having a small space doesn't mean you can't make a big impact! Formulate™ Master Tabletop displays are lightweight, highly-portable and come in Straight and Vertical Curved options. The frame assembles with easy-to-use snap buttons; simply pull the pillowcase fabric graphic over the frame and zip. All displays have an overall height of 46.5 inches, fit on a 6' wide table and come in a convenient transit case.

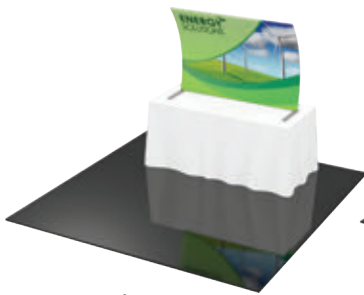

Formulate TT2
FMLT-WTT-V02



Formulate TT3
FMLT-WTT-V03

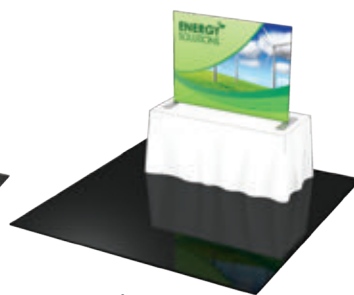

Formulate TT4
FMLT-WTT-S01

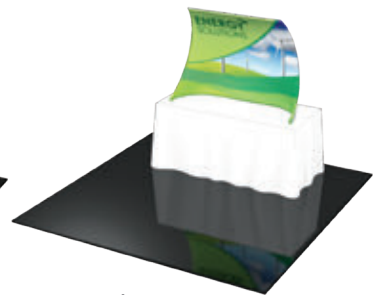

Formulate TT5
FMLT-WTT-S02



CLAMP
UC-FMLT



TABLET HOLDER
UC-VESA-BRKT



LIT HOLDER BRACKET
UC-LIT-BRKT-ABH-02
UC-LIT-BRKT-ABH-03



SHELF BRACKET
UC-SHLF-BRKT-01-CIR
UC-SHLF-BRKT-02-TRI
UC-SHLF-BRKT-03-SQU

**FORMULATE
UNIVERSAL
CONNECTORS
& ACCESSORIES**

The Formulate Universal Accessory system is designed to give you the freedom to add and change your accessories when you need to. Using a clamp that fits to the tube, easily attach a literature holder, shelf or iPad holder.



Formulate Lite and Master displays are made in the USA, come with a portable carry bag or case and a limited lifetime hardware warranty.

formulate™ master | 10' VERTICAL CURVED DISPLAYS

FORMULATE MASTER 10' VERTICAL CURVED DISPLAYS

Slightly arched from top to bottom, Formulate™ Master 10' Vertical Curved exhibits combine pillowcase fabric graphics with lightweight aluminum tube frames to form fashionable and functional exhibits. Accessories such as headers, adjustable literature holders, tables and accents provide enhanced functionality and more real estate for messaging. The wide array of Formulate Master Vertical Curved kits and accessories make it easy to glamorize any 10' space.



Formulate VC10
FMLT-WV10-10



Courtesy of:
CamelbackDisplays.com



Courtesy of: Motif Events



Courtesy of: Worldwide
Graphics & Sign Company

10' VERTICAL CURVED DISPLAYS | **formulate™ master**



Formulate VC1
FMLT-WV10-01



Formulate VC2
FMLT-WV10-02



Formulate VC3
FMLT-WV10-03



Formulate VC4
FMLT-WV10-04



Formulate VC5
FMLT-WV10-05



Formulate VC6
FMLT-WV10-06



Formulate VC7
FMLT-WV10-07



Formulate VC8
FMLT-WV10-08



Formulate VC9
FMLT-WV10-09



Formulate VC11
FMLT-WV10-11

FORMULATE MASTER | 10' VERTICAL CURVED DISPLAYS



*Monitors not included.

Formulate Master displays are made in the USA, come with portable cases and a limited lifetime hardware warranty.

formulate™ master | 10' HORIZONTAL CURVED DISPLAYS

FORMULATE MASTER 10' HORIZONTAL CURVED DISPLAYS

Ergonomically designed, Formulate™ Master 10' Horizontal Curved exhibits combine the latest developments in fabric printed technology with a gently curved aluminum frame to create a seamless, elegant exhibit that enhances the message of your exhibit or environment. Accents provide added functionality and messaging areas. With so many choices, you're sure to find a design that suits your desire for style!



FORMULATE MASTER | 10' HORIZONTAL CURVED DISPLAYS



Formulate HC1



Formulate HC2



Courtesy of: Hanscom Federal Credit Union



Formulate HC1
FMLT-WH10-01



Formulate HC2
FMLT-WH10-02

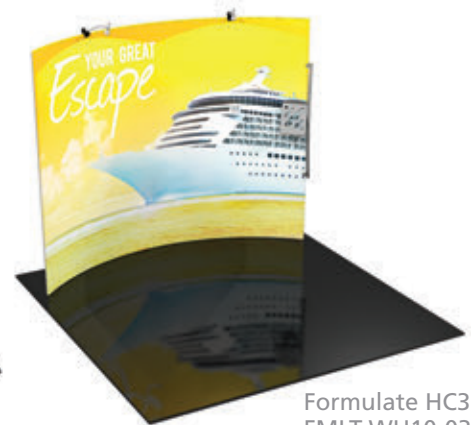

Formulate HC3
FMLT-WH10-03



Formulate HC4
FMLT-WH10-04



Formulate HC5
FMLT-WH10-05



Formulate HC7
FMLT-WH10-07

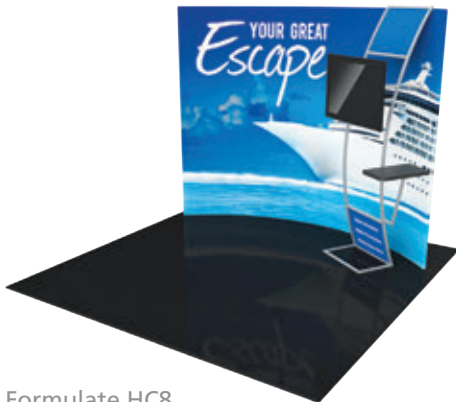

Formulate HC8
FMLT-WH10-08



Formulate HC9
FMLT-WH10-09



Formulate HC10
FMLT-WH10-10



*Monitors not included.

Formulate Master displays are made in the USA, come with portable cases and a limited lifetime hardware warranty.

formulate™ master | 10' STRAIGHT DISPLAYS

FORMULATE MASTER 10' STRAIGHT DISPLAYS

Space maximizing Formulate™ Master 10' Straight exhibits incorporate sleek, straight aluminum frames with zipper pillowcase fabric graphics to create a sharp, bold backwall that clearly conveys who you are and what you do. With a variety of accents including graphic headers, adjustable literature pockets, shelves, tables, counters and more, you are sure to find a design that best suits your space needs!



Formulate S5
FMLT-WS10-05



Formulate S1
FMLT-WS10-01



Formulate S2
FMLT-WS10-02



Formulate S3
FMLT-WS10-03



Formulate S4
FMLT-WS10-04



Formulate S6
FMLT-WS10-06



Formulate S7
FMLT-WS10-07

FORMULATE MASTER | 10' STRAIGHT DISPLAYS



Formulate Master displays are made in the USA, come with a portable case and a limited lifetime hardware warranty.

FORMULATE MASTER ACCENTS

Formulate™ Master Accents enhance the functionality of most Formulate Master 10' and 20' backwalls and add more real estate for messaging too! With monitor supports, literature pockets, shelves, tables, counters and more, you are sure to find the accent that best suits your needs. Side tables and graphic headers also available.

FORMULATE
BACKWALL CONNECTOR

FMLT-WBWC

The Formulate™ Master Backwall Connector is an ideal accessory to connect two 10' or 20' Formulate backwalls. It features a pillowcase fabric graphic and connects easily to create the appearance of one seamless display.

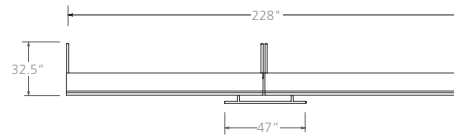

CONNECTOR 02
FMLT-WBWC-02

Pillowcase fabric graphic



CONNECTOR 03
FMLT-WBWC-03

Pillowcase fabric graphic and monitor mounts for a medium sized monitor*



CONNECTOR 04
FMLT-WBWC-04

Pillowcase fabric graphic

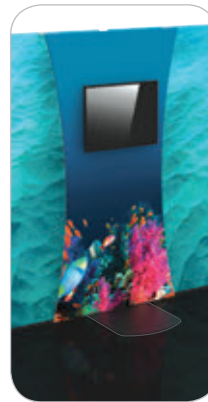

CONNECTOR 05
FMLT-WBWC-05

Pillowcase fabric graphic and monitor mounts for a medium sized monitor*



CONNECTOR 06
FMLT-WBWC-06

Pillowcase fabric graphic



CONNECTOR 07
FMLT-WBWC-07

Pillowcase fabric graphic and monitor mount for a medium sized monitor*

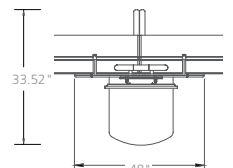
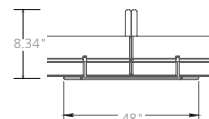
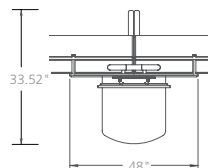
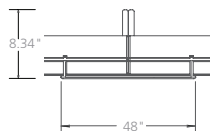
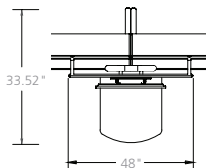
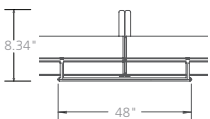

NEW

*Monitors not included.

formulate™ master | ACCENTS

FORMULATE MASTER ACCENTS

Formulate™ Master Accents enhance the functionality of many Formulate Master 10' and 20' backwalls and add more real estate for messaging too! With monitor supports, literature pockets, shelves, tables, counters and more, you are sure to find the accent that best suits your needs. Side tables and graphic headers also available.



ACCENT 01
FMLT-WL01

Pillowcase fabric graphic



ACCENT 02
FMLT-WL02

Three 20" w shelves and top and bottom printed infill panels



ACCENT 03
FMLT-WL03/ -L, -R

Choice of right-hand or left-hand arm tables, no table, top and bottom printed infill panels; fits a medium sized monitor*



ACCENT 04
FMLT-WL04

Features a 36" w table top, top and bottom velcro applied printed fabric graphics and hardware mounts for a medium sized monitor*



ACCENT 05
FMLT-WLLH

Three literature pockets, and top and bottom printed infill panels



ACCENT 06
FMLT-WLC

Features a 20" w shelf and top and bottom printed infill panels



Accent 02, 03, 03-R, 03-L & 06 are also available for rent



NEW

ACCENT 07
FMLT-WL07

- 36" w x 93.43" h x 18.21" d
- three 30.31" w shelves
- one 36" w graphic counter

ACCENT 08
FMLT-WL08

- 36" w x 92.1" h x 21.2" d
- rectangular shaped pillowcase fabric graphic
- wood platform

ACCENT 09
FMLT-WL09

- 37.55" w x 92.69" h x 11.07" d
- pillowcase fabric graphic



*Monitors not included.

Formulate Master accents are made in the USA, come with a portable case and a limited lifetime hardware warranty.

FORMULATE MASTER ACCENTS

NEW



ACCENT 10

FMLT-WL10

- 37.18" w x 93.18" h x 16.2" d
- medium monitor mount*
- one 36" w shelf

ACCENT 11

FMLT-WL11

- 37.18" w x 91.96" h x 16.85" d
- bottom shelf is 27.56" w
- top shelf is 21.26" w

ACCENT 12

FMLT-WL12

- 35.77" w (without monitor) x 92.39" h x 15" d
- dimensional pillowcase fabric graphic
- small monitor mount*
- three 18.5" w shelves

NEW



ACCENT 13

FMLT-WL13

- 48" w x 92.68" h x 14.26" d
- S-curved pillowcase fabric graphic

ACCENT 14

FMLT-WL14

- 51.72" w x 96.28" h x 27.72" d
- L-shaped pillowcase fabric graphic

ACCENT 15

FMLT-WL15

- 17.72" w x 96" h x 17.45" d
- L-shaped pillowcase fabric graphic
- three literature pockets



*Monitors not included.

Formulate Master accents are made in the USA, come with portable cases and a limited lifetime hardware warranty.

FORMULATE MASTER ACCENTS

Formulate™ Master Accents enhance the functionality of the Formulate Master 20' Straight backwall and add more real estate for messaging too!



BACKWALL ACCENT 01

FMLT-WBWA-01

- 227.07" w x 57.46" h x 9.22" d
- curved pillowcase fabric graphic attaches to a Formulate 20' Straight Master backwall



BACKWALL ACCENT 02

FMLT-WBWA-02

- 227.36" w x 45.83" h x 9.22" d
- slanted pillowcase fabric graphic attaches to a Formulate 20' Straight Master backwall



BACKWALL ACCENT 03

FMLT-WBWA-03

- 227.32w x 45.78" h x 9.22" d
- pillowcase fabric graphic attaches to a Formulate 20' Straight Master backwall



BACKWALL ACCENT 04

(straight) FMLT-WBWA-04S-L-R
(curved) FMLT-WBWA-04C-L-R

- (straight) 39.37" w x 35.43" h x 114.41" d
- (curved) 59.06" w x 35.43" h x 114.41" d
- L-shaped pillowcase divider walls attach to any Formulate Master Straight backwall

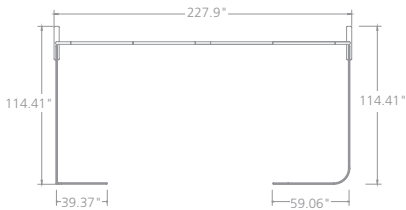

BACKWALL ACCENT 05

FMLT-WBWA-05

- 51.82" w x 96.87" h x 103.65" d
- L-shaped pillowcase fabric graphic attaches to any Formulate Master Straight style backwall
- 48.82" w tabletop included on interior of accent

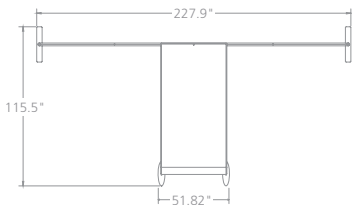

*only for use in peninsula or island tradeshow spaces

BACKWALL ACCENT 06

FMLT-WBWA-06

- 51.9" w x 98.99" h x 107.47" d
- one straight and one curved panel connect and attach to any Formulate Master Straight style backwall
- 44.94" w x 41.18" h x 14" d laminate counter included on interior of accent provides lockable storage

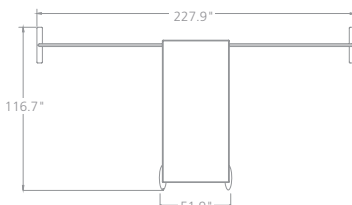

*only for use in peninsula or island tradeshow spaces



Formulate Master Accents are made in the USA, come with portable cases and a limited lifetime hardware warranty.

formulate™ master | 20' SERPENTINE CURVED DISPLAYS

FORMULATE MASTER 20' SERPENTINE CURVED DISPLAYS

The gentle and organic S-shaped curves of the Formulate™ Master Serpentine line of 20' exhibits create an elegant flow within a space. These displays can feature a single or double sided fabric graphic, which provides more real estate for branding and messaging. Pillowcase style fabric graphics are coupled with sturdy, yet lightweight aluminum frames to create the unique and flowing Serpentine shape. Accents provide shelving, surface areas, monitor displays and additional messaging areas.



Formulate SC2
FMLT-WSC-20-02

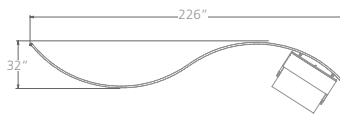

FORMULATE MASTER | 20' SERPENTINE CURVED DISPLAYS



Formulate SC1



Courtesy of: Hamilton Exhibits

20' SERPENTINE CURVED DISPLAYS | **formulate™ master**



Formulate SC1
FMLT-WSC20-01

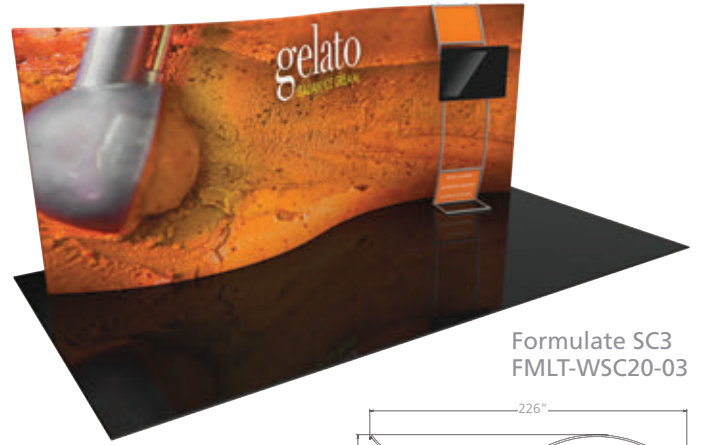
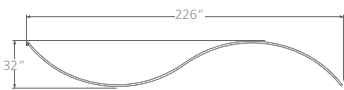

Formulate SC3
FMLT-WSC20-03

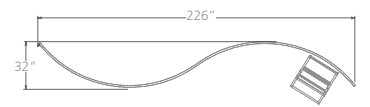

Formulate SC4
FMLT-WSC20-04

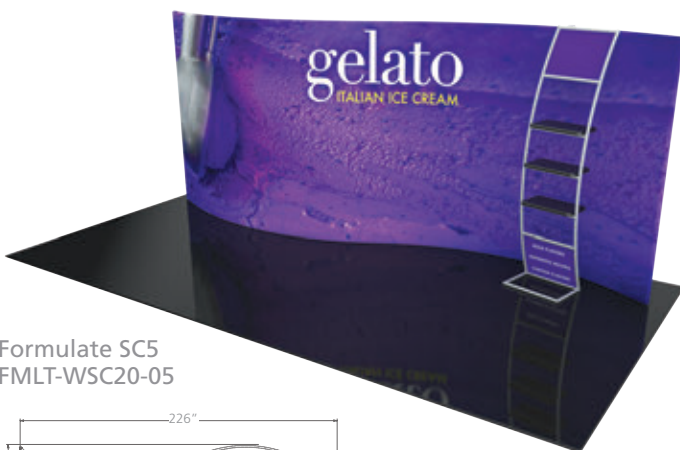
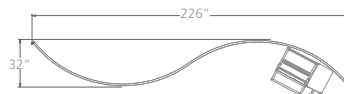

Formulate SC5
FMLT-WSC20-05

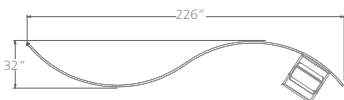

Formulate SC6
FMLT-WSC20-06

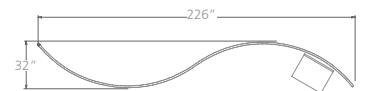

FORMULATE MASTER | 20' SERPENTINE CURVED DISPLAYS



*Monitors not included.

Formulate Master displays are made in the USA, come with a portable case and a limited lifetime hardware warranty.

formulate™ master | 20' VERTICAL CURVED DISPLAYS

FORMULATE MASTER 20' VERTICAL CURVED DISPLAYS

Slightly arched from top to bottom, Formulate™ Master 20' Vertical Curved displays combine pillowcase fabric graphics with lightweight aluminum tube frames to form fashionable and functional exhibits. Accents provide enhanced functionality and more real estate for messaging. The wide array of Formulate Master Vertical Curved kits and accessories make it easy to glamorize any 20' space. Easily convert the 20' Master Vertical Curve Formulate to a 10' backwall with the purchase of a 10' graphic. No additional hardware needed.



Formulate WV3
FMLT-WV20-03

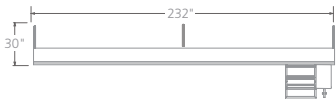

easily
converts to a
10' backwall



10' Vertical
Curved Backwall



Courtesy of: Eco Exhibits/Advantum Displays



Courtesy of: Eye Catching Solutions

20' VERTICAL CURVED DISPLAYS | formulate™ master



Formulate WV1
FMLT-WV20-01

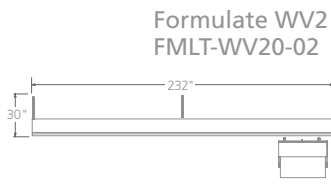

Formulate WV2
FMLT-WV20-02



Formulate WV4
FMLT-WV20-04

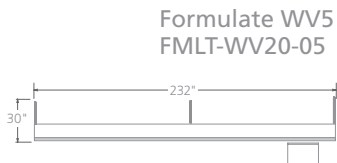

Formulate WV5
FMLT-WV20-05



FORMULATE MASTER | 20' VERTICAL CURVED DISPLAYS



*Monitors not included.

Formulate Master displays are made in the USA, come with a portable case and a limited lifetime hardware warranty.

formulate™ master | 20' HORIZONTAL CURVED DISPLAYS

FORMULATE MASTER 20' HORIZONTAL CURVED DISPLAYS

Ergonomically designed, Formulate™ 20' Master Horizontal Curved exhibit kits combine the latest developments in fabric printed technology with a gently curved aluminum frame to create a seamless, elegant exhibit that enhances the message of your exhibit or environment. Accents provide added functionality and messaging areas. With so many choices, you're sure to find a design that suits your desire for style! Easily convert the 20' Master Horizontal Curve Formulate to a 10' backwall with the purchase of a 10' graphic. No additional hardware needed.



Formulate WH4
FMLT-WH20-04



easily
converts to a
10' backwall



10' Horizontal
Curved Backwall



Formulate WH1
FMLT-WH20-01

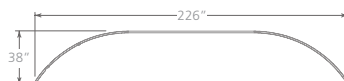

Formulate WH2
FMLT-WH20-02

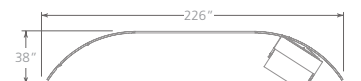

*Monitors not included.



Formulate WH3
FMLT-WH20-03



Formulate WH5
FMLT-WH20-05

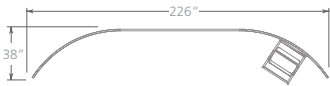

Formulate WH6
FMLT-WH20-06

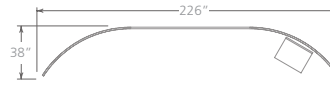

Formulate 20 Straight
FMLT-WS20-01



FORMULATE MASTER 20' STRAIGHT DISPLAY

The Formulate™ 20' Master Straight backwall incorporates a sleek, straight aluminum frame with a zipper pillowcase fabric graphic to create a sharp, bold backwall that clearly conveys who you are and what you do. Print on just one side or on both sides of the graphic to maximize your message and brand exposure!

FORMULATE MASTER | 20' HORIZONTAL CURVED & STRAIGHT DISPLAYS



*Monitors not included.

Formulate Master displays are made in the USA, come with a portable case and a limited lifetime hardware warranty.

formulate™ designer series | 10' DISPLAYS

FORMULATE DESIGNER SERIES 10' DISPLAYS

Formulate™ Designer Series exhibits and structures feature unique stylistic elements, making them modern and sophisticated in style. Formulate Designer Series structures couple lightweight aluminum frames with push-fit and zipper pillowcase fabric graphics. Formulate Designer Series fabric structures are formed with expert aluminum bending machinery and skilled welding and metal-working technicians.



FORMULATE DESIGNER SERIES KIT 08

FMLT-DS-10-08



NEW



10' DISPLAYS | formulate™ designer series

NEW

FORMULATE DESIGNER SERIES 10' DISPLAYS

Formulate™ Designer Series 10' displays have unique stylistic features and shapes, are portable and easy to assemble. The aluminum tube frame features snap-buttons and zipper pillowcase fabric graphics. All displays come in portable, wheeled transit cases. Simply pull the pillowcase fabric graphic over the frame and zip.



FMLT-DS-10-01

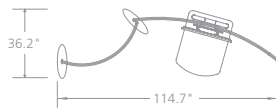

FMLT-DS-10-02

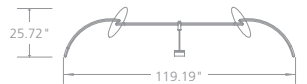

FMLT-DS-10-03



FMLT-DS-10-04



*Monitors not included.

Formulate Designer Series displays are made in the USA, come with portable cases and a limited lifetime hardware warranty.



formulate™ designer series | 10' DISPLAYS

FORMULATE DESIGNER SERIES 10' DISPLAYS



Formulate™ Designer Series 10' displays have unique stylistic features and shapes, are portable and easy to assemble. The aluminum tube frame features snap-buttons and zipper pillowcase fabric graphics. All displays come in portable, wheeled transit cases. Simply pull the pillowcase fabric graphic over the frame and zip.



FMLT-DS-10-05



FMLT-DS-10-06

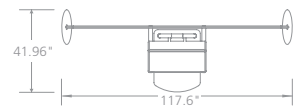

FMLT-DS-10-07

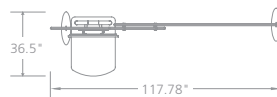

FMLT-DS-10-09

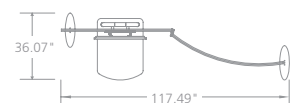

*Monitors not included.

Formulate Designer Series displays are made in the USA, come with portable cases and a limited lifetime hardware warranty.



10' DISPLAYS | formulate™ designer series

NEW

FORMULATE DESIGNER SERIES
10' DISPLAYS



FMLT-DS-10-10

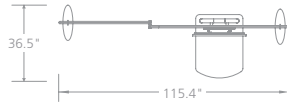

FMLT-DS-10-11

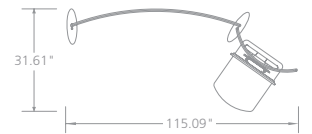

FMLT-DS-10-12

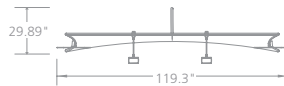

FMLT-DS-10-13

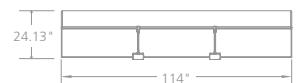

*Monitors not included.

Formulate Designer Series displays are made in the USA, come with portable cases and a limited lifetime hardware warranty.

formulate™ designer series | 20' DISPLAYS

FORMULATE DESIGNER SERIES 20' DISPLAYS



Formulate™ Designer Series 20' inline exhibits feature unique stylistic elements, making them modern and sophisticated in style. Formulate Designer Series structures couple lightweight aluminum frames with stretch, zipper pillowcase fabric graphics. Formulate Designer Series fabric structures are formed with expert aluminum bending machinery and skilled welding and metal-working technicians.



FMLT-DS-20-01

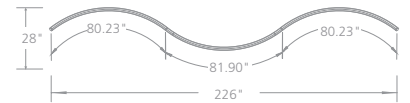

FMLT-DS-20-02

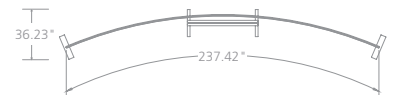

Formulate Designer Series displays are made in the USA, come with portable cases and a limited lifetime hardware warranty.

20' DISPLAYS | formulate™ designer series

NEW

FORMULATE DESIGNER SERIES
20' DISPLAYS



FMLT-DS-20-03

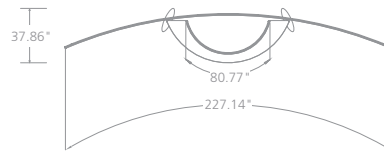

FMLT-DS-20-04



FMLT-DS-20-05

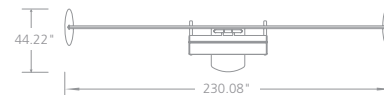

*Monitors not included.

Formulate Designer Series displays are made in the USA, come with portable cases and a limited lifetime hardware warranty.



formulate™ designer series | 20' DISPLAYS

FORMULATE DESIGNER SERIES 20' DISPLAYS



Formulate™ Designer Series 20' inline exhibits feature unique stylistic elements, making them modern and sophisticated in style. Formulate Designer Series structures couple lightweight aluminum frames with stretch, zipper pillowcase fabric graphics. Formulate Designer Series fabric structures are formed with expert aluminum bending machinery and skilled welding and metal-working technicians.



FMLT-DS-20-06

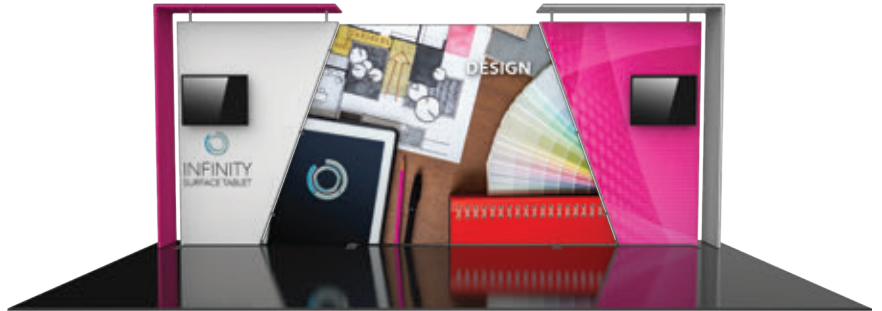

FMLT-DS-20-07

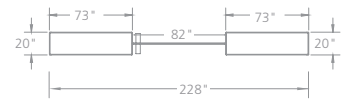

FMLT-DS-20-08

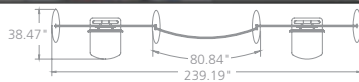

FMLT-DS-20-09

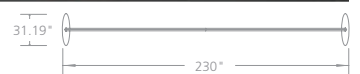

*Monitors not included.

Formulate Designer Series displays are made in the USA, come with portable cases and a limited lifetime hardware warranty.



20' DISPLAYS | formulate™ designer series

NEW

FORMULATE DESIGNER SERIES
20' DISPLAYS



FMLT-DS-20-10

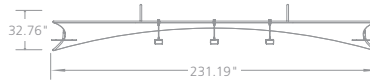

FMLT-DS-20-11



FMLT-DS-20-12



FMLT-DS-20-13



*Monitors not included.

Formulate Designer Series displays are made in the USA, come with portable cases and a limited lifetime hardware warranty.



formulate™ designer series | 30' DISPLAYS

FORMULATE DESIGNER SERIES 30' DISPLAYS



Formulate™ Designer Series 30' kits come in Straight, Straight Layered, Vertical Curve, Horizontal Curve and Serpentine Curve options. Formulate Designer Series 30' displays feature USA-made lightweight aluminum tube frames and pillowcase fabric graphics that simply slide over the frame and zip at the bottom.



FMLT-DS-30-01



FMLT-DS-30-02



FMLT-DS-30-03

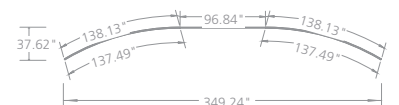

FORMULATE DESIGNER SERIES | 30' DISPLAYS



Formulate Designer Series displays are made in the USA, come with portable cases and a limited lifetime hardware warranty.

30' DISPLAYS | **formulate™ designer series**

NEW

FORMULATE DESIGNER SERIES
30' DISPLAYS



FMLT-DS-30-04

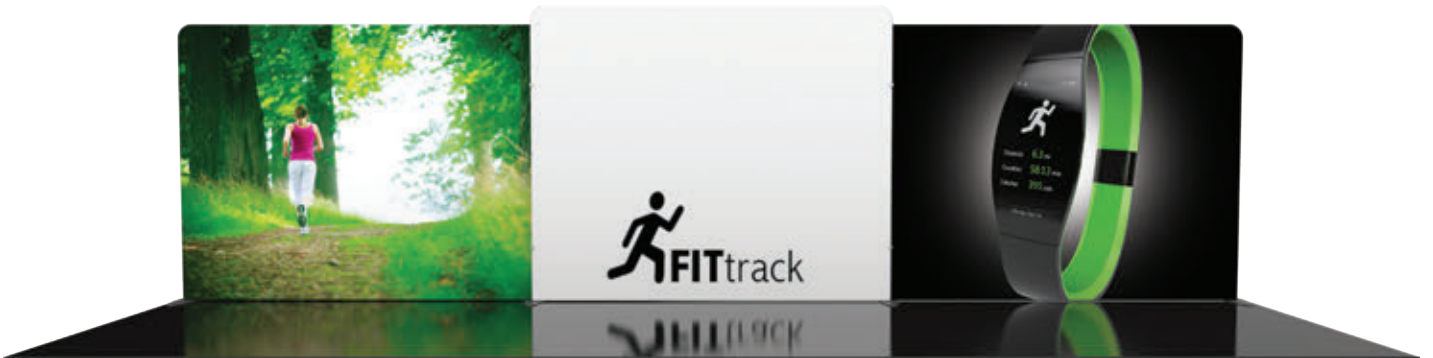

FMLT-DS-30-05



FMLT-DS-30-06

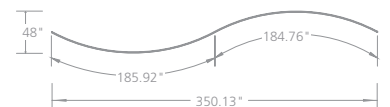

FORMULATE DESIGNER SERIES | 30' DISPLAYS



Formulate Designer Series displays are made in the USA, come with portable cases and a limited lifetime hardware warranty.

SPIN OR FLIP

TO CREATE A DIFFERENT LOOK
& SHOW A NEW MESSAGE!

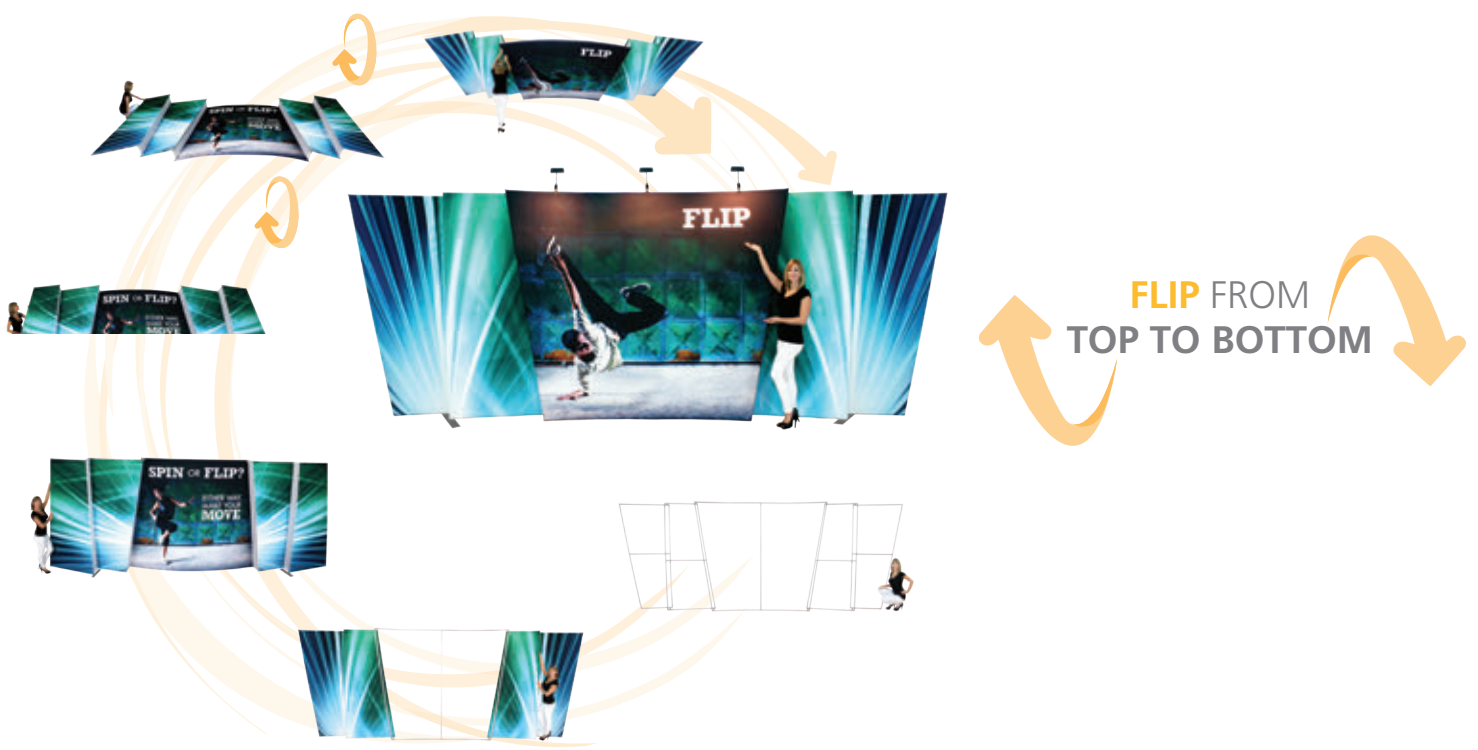
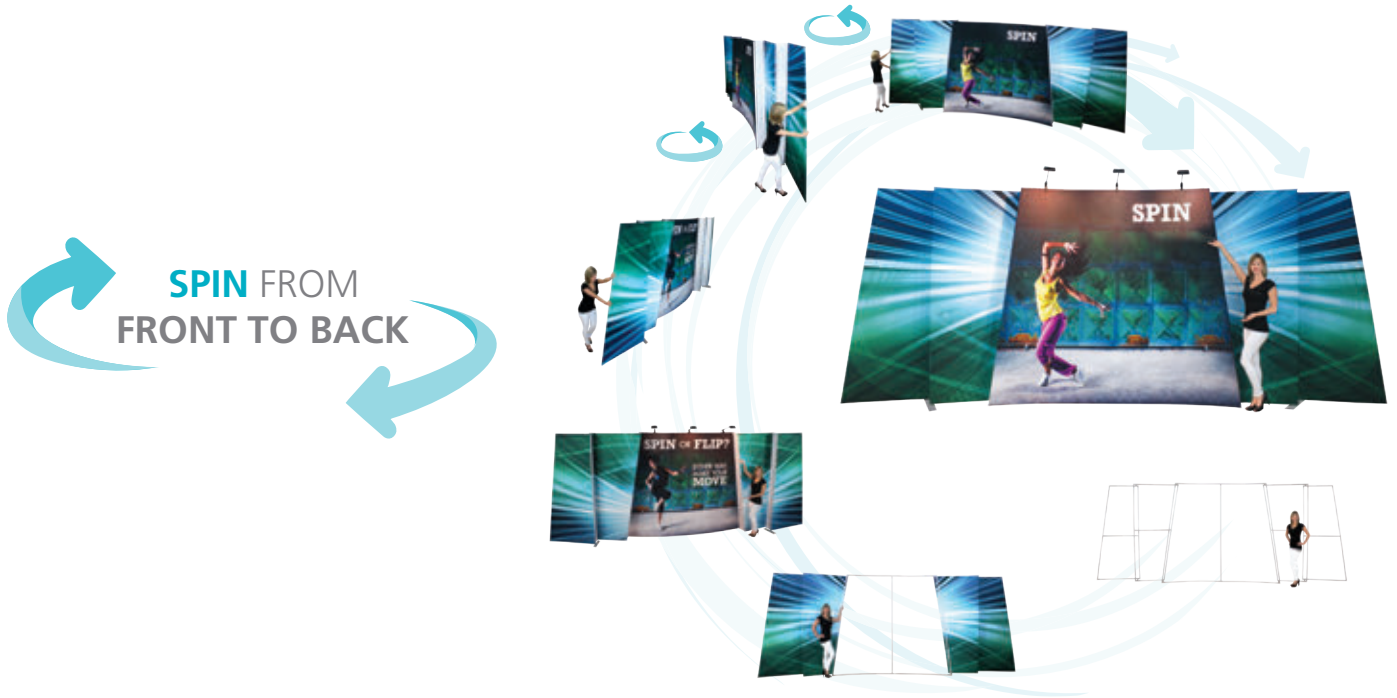

Formulate Flip kits are made in the USA, come with portable cases and a limited lifetime hardware warranty.

FLIP 20' EXHIBIT KITS

FLIP™ 20' exhibits incorporate layered, staggered walls that are connected to create a unique, dimensional and versatile display. Ask to incorporate LED lights to make your FLIP™ display shine.

SO FLIPPIN' COOL

Double sided graphics enable you to feature a different look, brand or messaging so you can **SPIN from front to back** OR use as a creative space divider for a larger space. With an easy graphic change, you can also **FLIP from top to bottom** to create a new, different exhibit and look for your next event.

SO FLIPPIN' EASY

FLIP kits combine 30mm lightweight aluminum frames with your choice of single or double sided zipper pillowcase fabric graphics. Simply join the aluminum tubes together with strong internal spigots, slide the fabric graphics over the frames, then zip. It's that easy.



FLIP-01

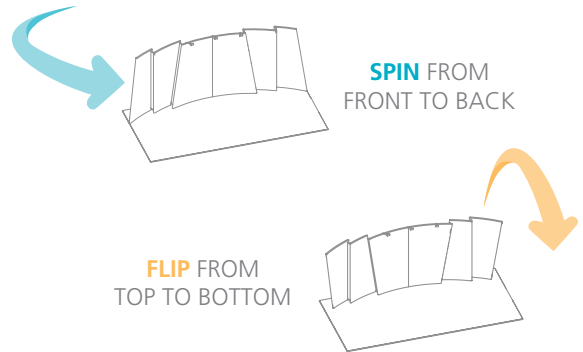

FLIP-03

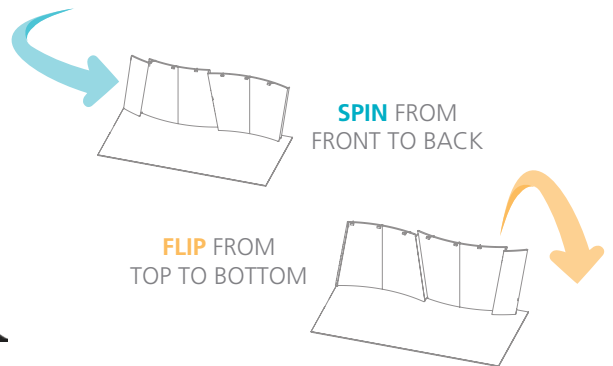

FLIP-04

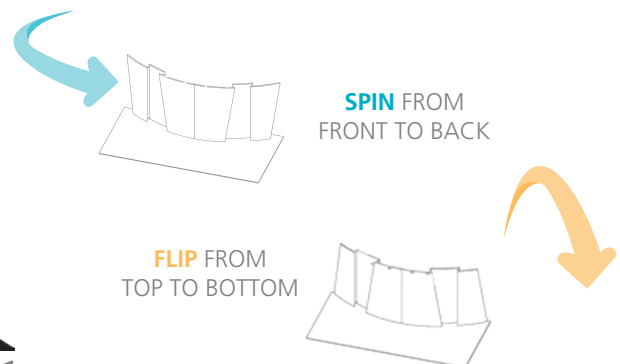
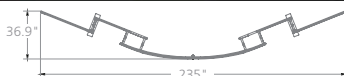

*Counters, lighting and lighting hardware not included in kits. A la carte counter options presented on pages 134-135.

VIBE 10' EXHIBIT KITS

Vibe™ is a collection of cleverly-designed, dimensionally layered 10' exhibit kits. Vibe combines layered lightweight aluminum tube frames with zippered pillowcase printed fabric graphics. Unique shapes, angles and exposed framework create a truly unique appearance and experience. Where they appear, kits include graphic headers, lights and monitor kiosks to provide additional branding and messaging areas.



KIT 05
VBK-5



Vibe kits are made in the USA, come with portable carry cases and a limited lifetime hardware warranty.



KIT 01
VBK-1



KIT 02
VBK-2



KIT 03
VBK-3

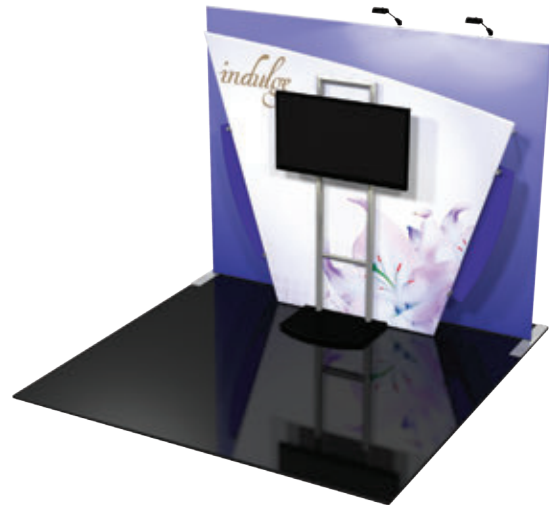

KIT 06
VBK-6



VIBE MONITOR KIOSK

VB-MK-01

Simply add the Vibe™ kiosk to create an interactive, multimedia display. Kiosk comes with a monitor bracket that holds a max weight of 50 lbs and a convenient, portable shipping case. Monitor is not included with kiosk or kit.

formulate™ fusion | 20' x 20' ISLAND EXHIBIT KITS

Formulate™ Fusion provides an unparalleled dynamic that elevates and accentuates a message and brand, but also maximizes the return on tradeshow investment. Formulate Fusion is a collection of island exhibit kits and custom solutions. A fusion of FORM, FABRIC and FUNCTION, these kits combine organic and architectural shapes with state-of-the-art zipper pillowcase dye-sublimated fabric graphics to create unique, dynamic and functional island spaces. All Formulate Fusion exhibits and graphics are made in the USA.



FORMULATE FUSION KIT 02

CFAB-K-02

You won't get bypassed with this 20' x 20' island exhibit in your next event or tradeshow!

Formulate™ Fusion Kit 02 features a fabric archway, a dimensional hanging structure and curved conference area to create a space that fosters flow, yet provides privacy for meetings and demonstrations. Each display element combines state-of-the-art zipper pillowcase dye-sublimated fabric coverings with advanced lightweight aluminum tube structures.

The overhead hanging structure is 13' wide, 5' tall and 1' thick, providing ample space for a company brand. The prominent arch spans 14' wide and reaches 11 ½' high. An 8' tall by 9 ½' wide fabric backwall is positioned behind the fabric display counter to add a messaging area, privacy and a display surface on the interior side. An 8' tall "potato chip" shaped, curved fabric wall creates a semi-private conference/meeting area or projection wall within the space. Monitor mounts and stylish display lighting are included.

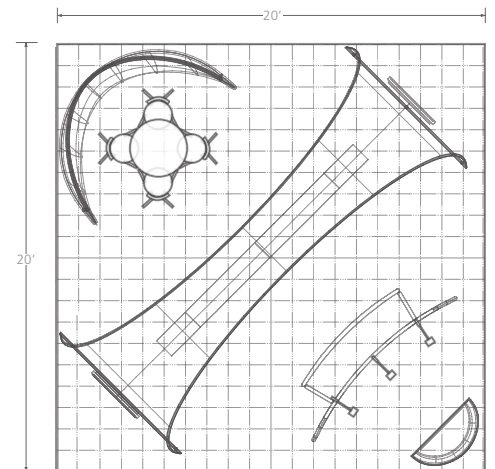



FORMULATE FUSION KIT 05

CFAB-K-05



Dominate the exhibit hall with this 20' x 20' island exhibit and stand out from the rest!

Formulate™ Fusion Kit 05 combines architectural lines and shapes with the latest developments in fabric to create a sophisticated, memorable and breathtaking presence.

The 18' tall fabric covered tower centerpiece features a 7' diameter cone and three curved architectural support beams. You can easily incorporate monitors and AV into the support structures to add multimedia messaging. The reception counter features a white laminate base and printed slat accents, as well as abundant lockable storage.

Monitor mounts are included. Internal LED light kits are not included, but can be purchased à la carte to add a glow within the support structures.

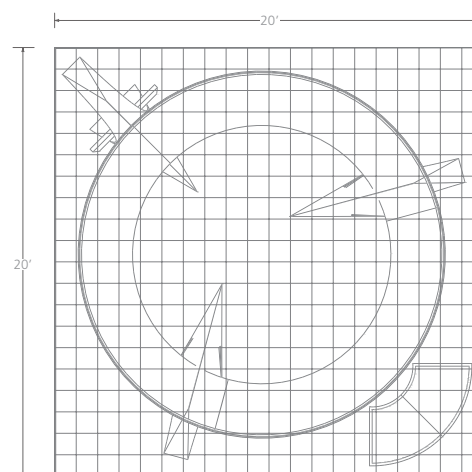

*Monitors not included.

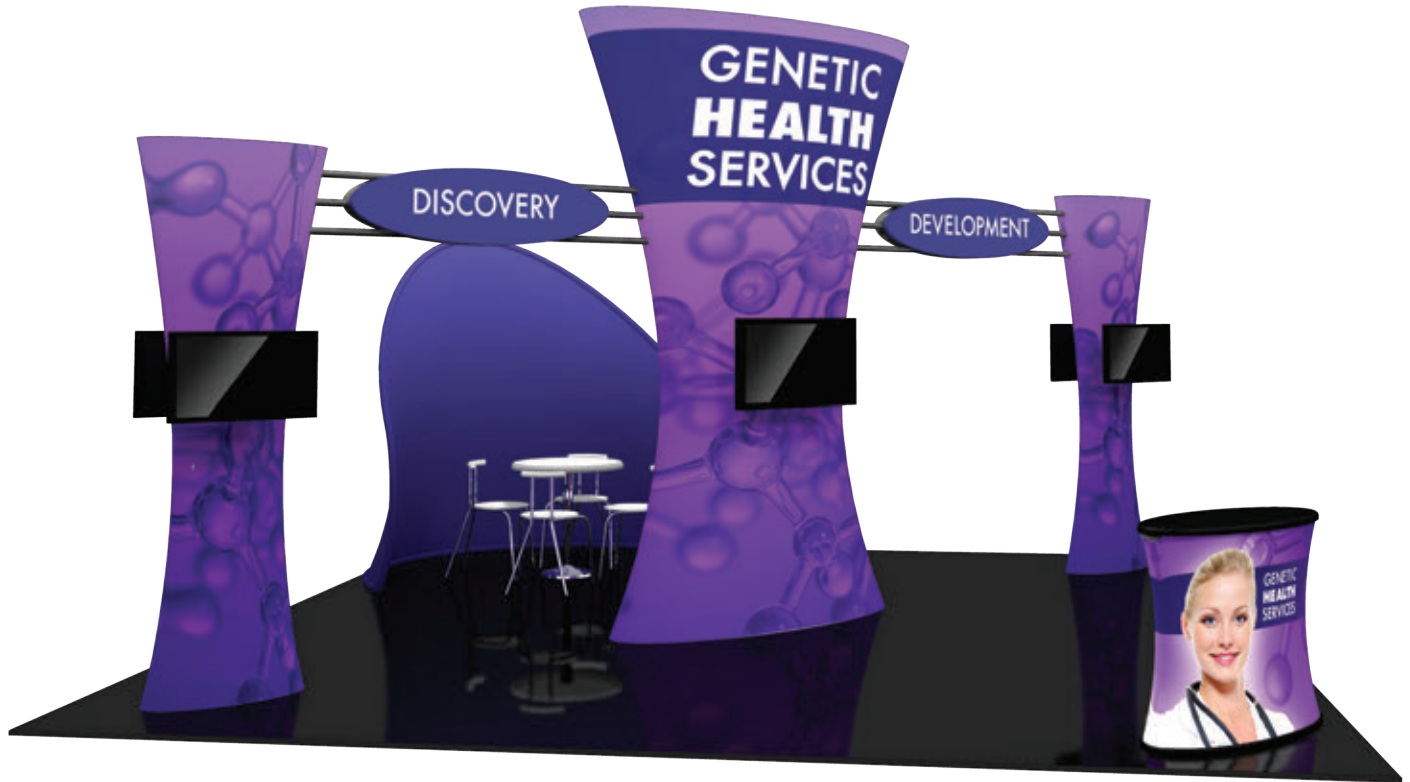

FORMULATE FUSION KIT 06

CFAB-K-06

An airy floor plan encourages maximum traffic flow into this 20' x 20' island exhibit!

Formulate™ Fusion Kit 06 features structures that combine the latest developments in fabric printed technology with heavy-duty aluminum frames to create a space that fosters great traffic flow and conversation areas.

The 12' tall center fabric tower is connected to two 9' tall fabric towers via exposed aluminum tube. Oval-shaped sintra panels are located on front and back sides of the aluminum tubes providing four messaging and branding areas. An oval-shaped fabric reception counter provides a fashionable, yet functional greeting area. Additionally, an 8' tall "potato chip" shaped, curved fabric wall creates a semi-private conference/meeting area or projection wall within the space.

Six monitor mounts are included. Internal LED light kits are not included, but can be purchased a la carte to add a glow within the three tower structures.

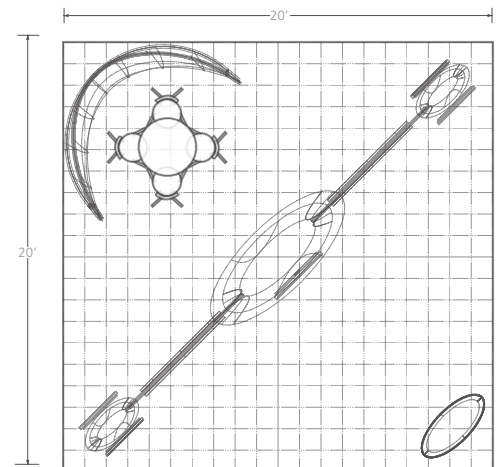

*Monitors and furniture not included.

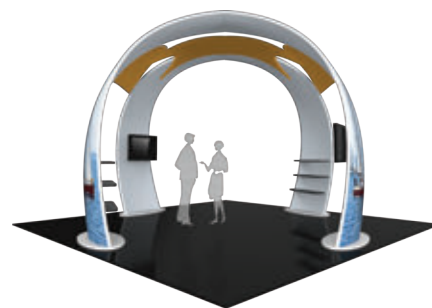
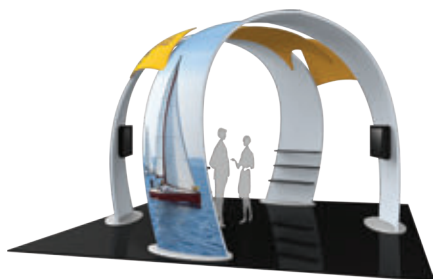
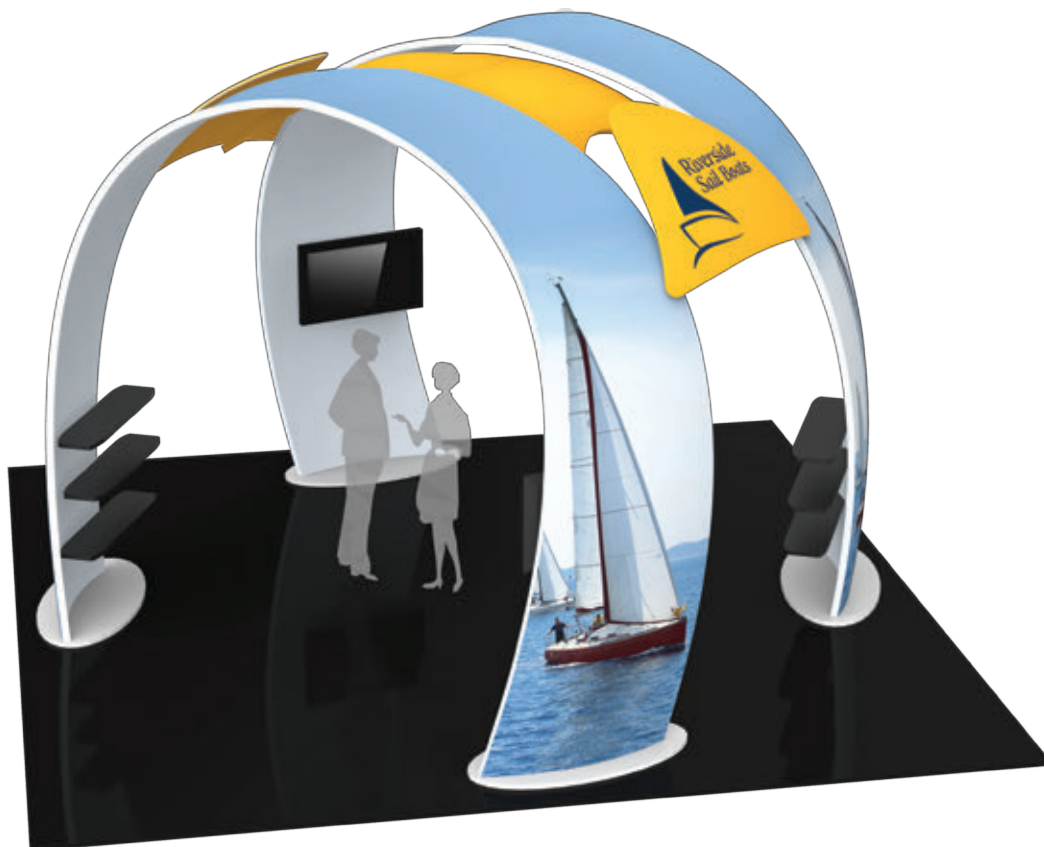

FORMULATE FUSION KIT 07

CFAB-K-07



This organically-shaped, eye-catching structure allows for ample floor space for traffic flow, product demonstrations and engaging meetings.

The 12.5' tall, 16' wide curved fabric arches provide areas within the space for shelving to display merchandise and products, as well as two areas for TVs to display digital media. One centrally-located fabric structure sits slightly underneath and in the middle of the two main arches, providing additional real estate for messaging and branding. Two canopy-like accent fabric structures connect the arches and are perfect areas for your company logo.

Formulate™ Fusion 07 combines five lightweight tubular frame structures with zipper-pillowcase fabric graphics. Display shelves and monitors mounts are included; medium monitor mounts hold 40-50" TVs up to 50 lbs.

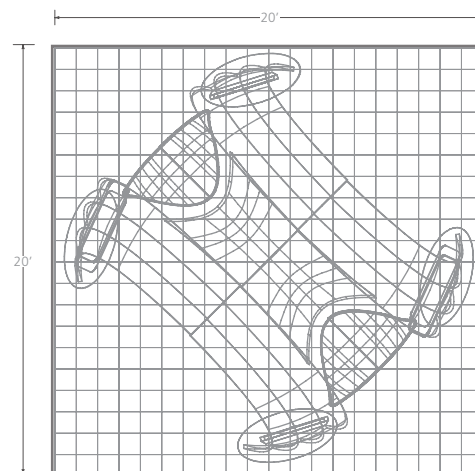

*Monitors not included.



FORMULATE FUSION KIT 08
CFAB-K-08



Engage your audience inside this 20' x 20' island display at your next event! Formulate™ Fusion Kit 08 provides ample floor space for traffic flow, product demonstrations and semi-private meetings.

The main arch structure is 15' 8" tall and has a footprint that spans 27' 3", which requires that it is placed in a 20' x 20' exhibit space on a diagonal. Two oval-shaped accents mounted on the sides of the arch provide areas for company branding and messaging. Two structural accent displays are placed on the inside of the archway anchors, each featuring three 29.5" illuminated squares that can be used to feature product or service images, taglines, branding and more. These displays stand 105" tall and are 42" wide.

Host meetings in the semi-private conference room, which can fit a 36" diameter bistro style table four chairs or stools. The oval fabric counter can be used for reception and storage.

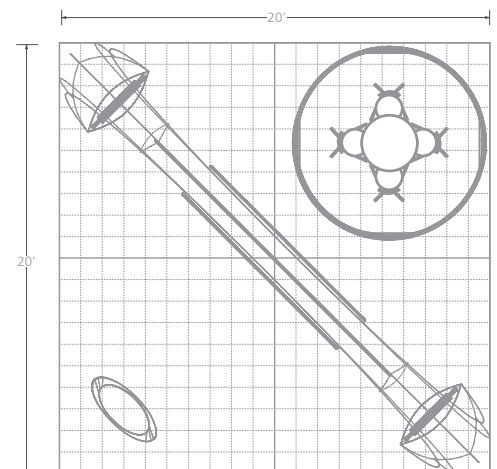



FORMULATE FUSION KIT 09

CFAB-K-09



Monopolize the tradeshow floor with the bold, sophisticated presence of Formulate™ Fusion Kit 09.

Standing 14' tall and over 10' wide, the L-shaped exhibit structure features a roof-top that extends 18' into the exhibit space. This main structure is comprised of an aluminum tube frame, coupled with pillowcase fabric graphics. This main fabric structure is structurally supported by a freestanding laminated counter that is 7' 10.5" wide by 3' h by 2.5' deep, providing plentiful secure storage and counter-top space.

Two structural walls are positioned at 45 degree angles in the space and stand 11' tall by 5' wide, with a depth of 1.5'. The rectangular structures combine heavy-duty aluminum extrusion frames with push-fit fabric graphics, which are designed for bold, vibrant graphics and messaging! A freestanding laminated reception counter establishes the area for exhibit staff to meet and greet guests.

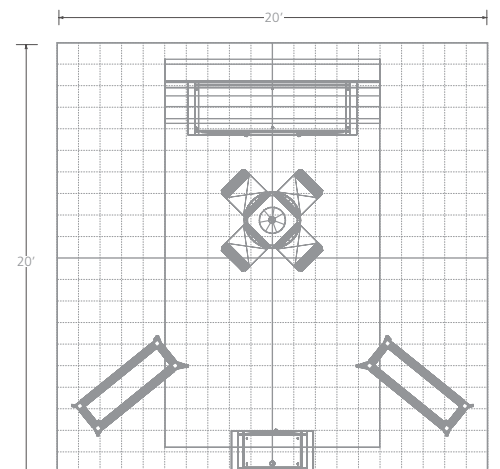

*Monitors and furniture not included.

formulate™ fusion | 20' x 20' ISLAND EXHIBIT KITS



FORMULATE FUSION KIT 10

CFAB-K-10

NEW

Formulate™ Fusion Kit 10 combines a variety of off-the-shelf Formulate fabric structures to create a dynamic and charming exhibit!

Hanging above is a rounded-corner 16' square hanging structure, designed to proclaim your brand and help visitors find you in a crowded exhibit hall.

Four 10' tall, 5' wide towers anchor each corner and are intended to help draw traffic inside the booth and engage passersby with multimedia messaging. Each tubular fabric tower features two 40-50" medium monitors to display digital media. A chip-shaped fabric wall sits near the center of the floor space, providing a semi-private meeting space that fits a small bistro-style table and three chairs or stools. A freestanding pillar-shaped fabric counter serves as an area for conversation and reception.

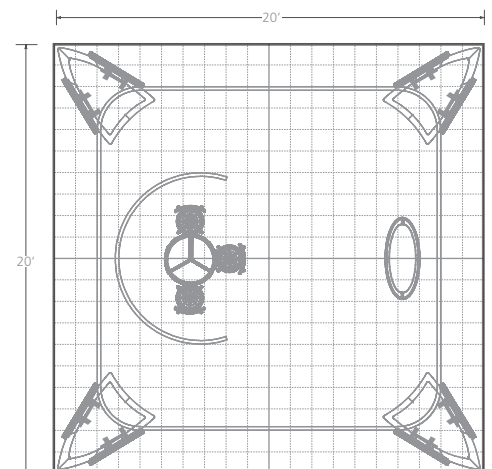

*Monitors and furniture not included.

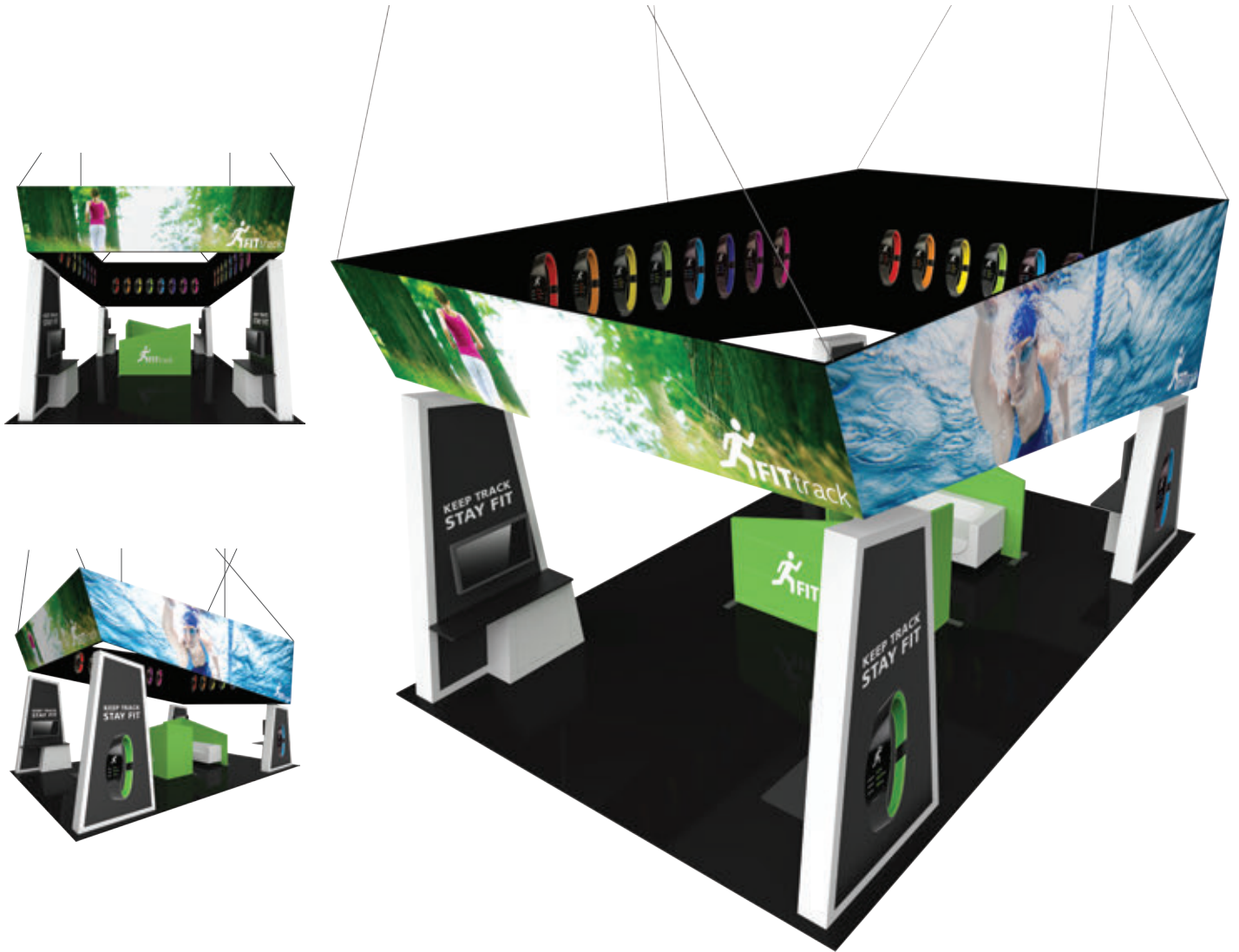

FORMULATE FUSION KIT 11
CFAB-K-11



This bold and dominant 20' x 30' exhibit certainly won't be one that attendees simply walk past.

A big, bold trapezoidal-shaped fabric structure hangs just slightly above the four mirrored trapezoidal-shaped corner towers. The large fabric hanging structure provides a plethora of real estate for branding, imagery and messaging to draw visitors into the exhibit space. The corner tower structures feature laminated wood perimeters and push-fit fabric graphics; wood counters stand in front of the towers, providing structural support and secure storage. Above each of the four counters are areas for large TV monitors to display digital media.

In the center of the space are two L-shaped divider walls, designed to help create a semi-private space for meetings.

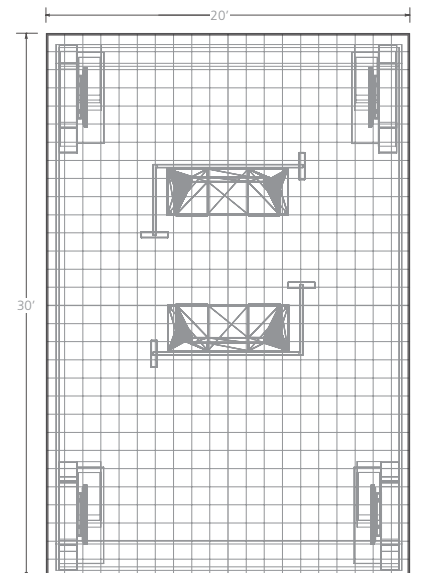

*Monitors and furniture not included.

formulate™ | TENSION FABRIC COUNTERS



FORMULATE™ COUNTERS

Formulate™ counters couple lightweight hardware with state-of-the-art printed stretch silicone edge push-fit fabric graphics to create funky and functional reception stands.



PILLAR
W-01-C 



HALF MOON
W-02-C



ELLIPSE
W-03-C 



BULLET
W-04-C



OVAL
W-05-C 



BAR
W-06-C 



Half Moon



Illuminated Oval



Bullet

FORMULATE | TENSION FABRIC COUNTERS

SYMPHONY™ COUNTERS

Symphony™ counters provide a unique, sleek design that lends an attractive element to any trade show or POP display. Symphony counters combine extrusion-based hardware with state-of-the-art PRINTED or SOLID COLOR stretch push-fit fabric graphics.



OVAL
SYM-OV



RECTANGLE
SYM-RCT



BULLET
SYM-BLLT



OVAL DOUBLE GRAND
SYM-OV-DBL-GRND



3 QUAD KIT
SYM-QD-3

tension fabric counter tops are available in your choice of finishes



silver black mahogany natural

counter stretch skirts are available in custom printed options as well as the following colors:



amethyst ruby sapphire emerald silver jet



Half Moon



Half Moon



Half Moon

FORMULATE CHARGING STATIONS



Formulate™ Charging Stations add technology and great value for visitors in need of a quick charge. Excellent for retail applications, trade shows and events.

CHARGING TOWER

FMLT-CHRG-01

- 33.56" w x 86.81" h x 33.46" d
- features 16 high-speed charging tips: (8) Micro USB for Android devices and (8) Apple 8-pin for Apple iPhone/iPad/ Lightning devices
- features a circular fabric header for branding and an illuminated fabric center structure
- base and tabletop color offered in choice of four thermoform color options



CHARGING COUNTER

FMLT-CHRG-COUNTER-01

- 23.72" w x 41.54" h x 23.62" d
- features 8 high-speed charging tips: (4) Micro USB for Android devices and (4) Apple 8-pin for Apple iPhone/iPad/ Lightning devices
- features stretch fabric graphic
- tabletop offered in choice of four thermoform color options



TENSION FABRIC iPad STANDS

Are you looking to incorporate iPads into your display or environment? Sleekly-designed free standing iPad stands and kiosks make it easy to encourage interactivity, present information and engage your customers in any space. Stands feature stretch fabric graphics.



iPAD STAND 01
TABLET-STD-01

- 30" w x 84" h x 23" d
- small monitor mount*, holds 32" TV/32lbs max
- iPad holder (2nd, 3rd, 4th gen and Air models)*
- pillowcase fabric graphic



iPAD STAND 02
TABLET-STD-02

- 20.25" w x 85.11" h x 23.8" d
- iPad holder (2nd, 3rd, 4th gen and Air models)*
- pillowcase fabric graphic



iPAD STAND 03
TABLET-STD-03

- 19.98" w x 64.34" h x 15.2" d
- iPad holder (2nd, 3rd, 4th gen and Air models)*
- pillowcase fabric graphic



iPAD STAND 04
TABLET-STD-04

- 26.26" w x 46.26" h x 22.64" d
- iPad holder (2nd, 3rd, 4th gen and Air models)*
- pillowcase fabric graphic

NEW

*Monitor and devices not included.

Charging stations and kiosks are available in your choice of four thermoform finishes



NEW

FORMULATE™ KIOSKS

Formulate™ Kiosks couple lightweight aluminum tube frames with state-of-the-art printed stretch zipper pillowcase fabric graphics to create funky and functional multimedia kiosks.



KIOSK 1
FMLT-KIOSK-01

- 29.53" w x 98.53" h x 31.78" d
- pillowcase fabric graphic
- supports medium monitor*

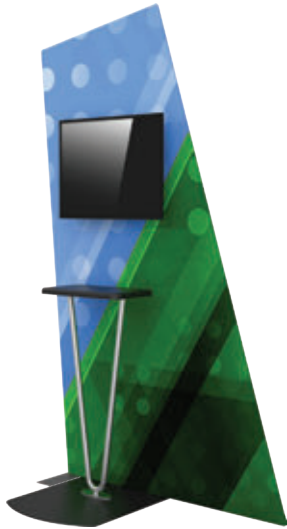

KIOSK 2
FMLT-KIOSK-02

- 61.72" w x 98.16" h x 34.57" d
- pillowcase fabric graphic
- supports medium monitor*



KIOSK 3
FMLT-KIOSK-03

- 55.12" w x 98.61" h x 36.03" d
- pillowcase fabric graphic
- supports medium monitor*



KIOSK 4
FMLT-KIOSK-04

- 39.37" w x 92.52" h x 35.75" d
- pillowcase fabric graphic
- supports medium monitor*

*Monitors not included.



FORMULATE ESSENTIAL HANGING STRUCTURES



Formulate™ Essential fabric hanging structures are an economy range of standard, simple hanging structure shapes. The customary, economy aluminum tube frame features bungee cords and comes with a one year limited hardware warranty. Simply pull the pillowcase fabric graphic over the frame and zip. Essential hanging structure graphics do not come with a liner.

RING

8' diam. x 2'h/3'h/4'h
 10' diam. x 2'h/3'h/4'h
 12' diam. x 2'h/3'h/4'h

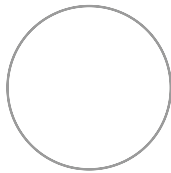

double sided graphic



bottom graphic

SQUARE

8'w x 2'h/3'h/4'h
 10'w x 2'h/3'h/4'h
 12'w x 2'h/3'h/4'h

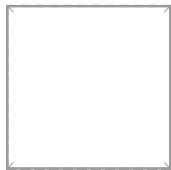

double sided graphic



bottom graphic

TRIANGLE

8'w x 2'h/3'h/4'h
 10'w x 2'h/3'h/4'h
 12'w x 2'h/3'h/4'h



double sided graphic



bottom graphic



Formulate Essential hanging structures come with a one year limited hardware warranty.

FORMULATE MASTER HANGING STRUCTURES

Formulate™ tension fabric hanging structures are made in the USA and are of the utmost quality and durability. Formulate combines state-of-the-art zipper pillowcase dye-sublimated stretch fabric coverings with advanced, lightweight aluminum structures to provide unique design, functionality, and style. The excellence of the Formulate line of hanging structures is simply unmatched!

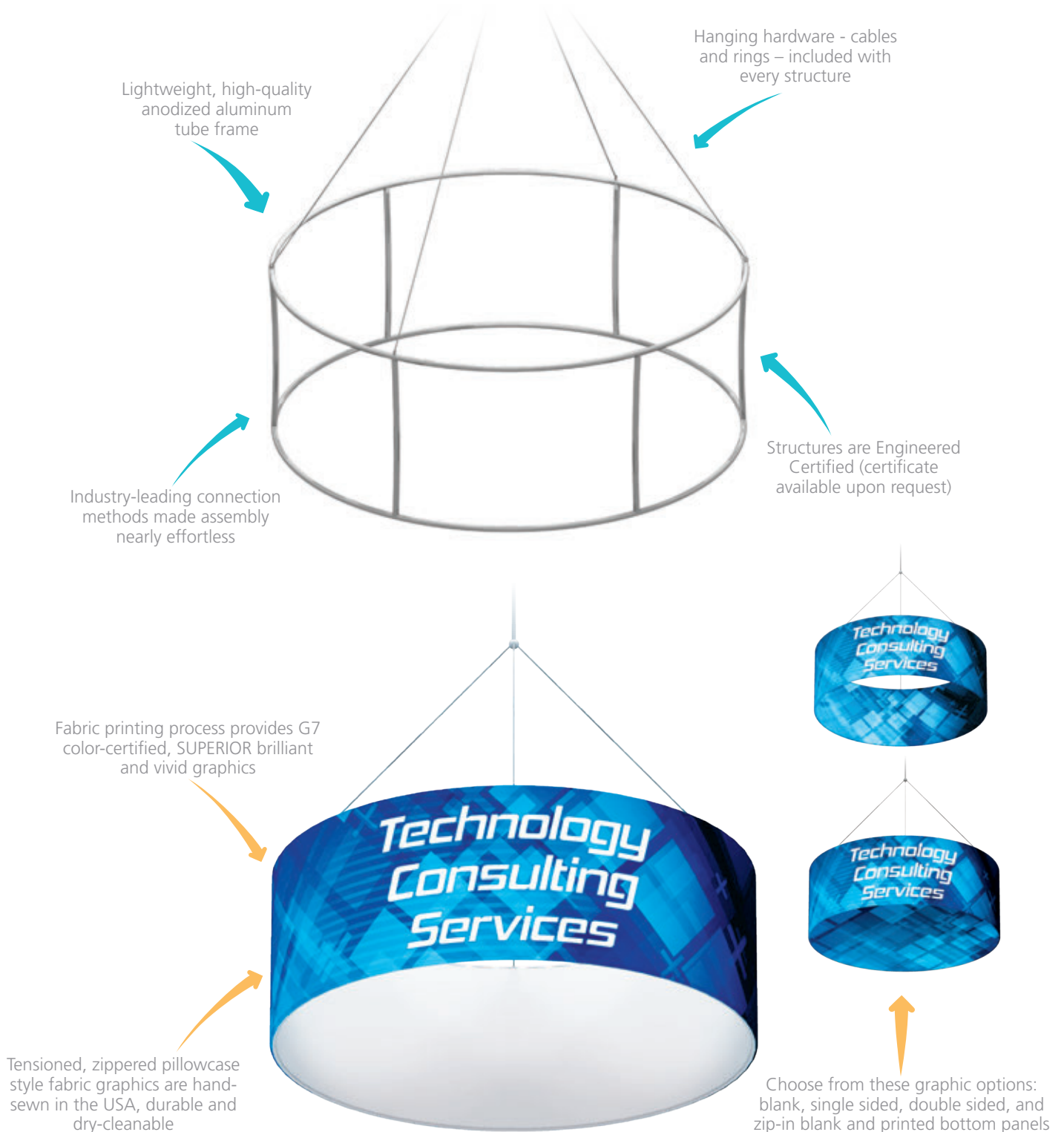

Formulate Master hanging structures are made in the USA and have a limited lifetime hardware warranty.

RING

8' diam. x 2'h/3'h/4'h/5'h/6'h
 10' diam. x 2'h/3'h/4'h/5'h/6'h
 12' diam. x 2'h/3'h/4'h/5'h/6'h
 14' diam. x 2'h/3'h/4'h/5'h/6'h
 16' diam. x 2'h/3'h/4'h/5'h/6'h
 18' diam. x 2'h/3'h/4'h/5'h/6'h
 20' diam. x 2'h/3'h/4'h/5'h/6'h

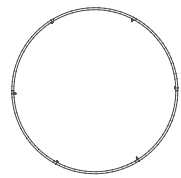

double sided graphic



bottom graphic

TAPERED RING

8' diam. x 2'h/3'h/4'h/5'h/6'h
 10' diam. x 2'h/3'h/4'h/5'h/6'h
 12' diam. x 2'h/3'h/4'h/5'h/6'h
 14' diam. x 2'h/3'h/4'h/5'h/6'h
 16' diam. x 2'h/3'h/4'h/5'h/6'h
 18' diam. x 2'h/3'h/4'h/5'h/6'h
 20' diam. x 2'h/3'h/4'h/5'h/6'h

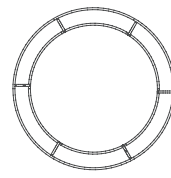

double sided graphic

SQUARE

8'w x 2'h/3'h/4'h/5'h/6'h
 10'w x 2'h/3'h/4'h/5'h/6'h
 12'w x 2'h/3'h/4'h/5'h/6'h
 14'w x 2'h/3'h/4'h/5'h/6'h
 16'w x 2'h/3'h/4'h/5'h/6'h
 18'w x 2'h/3'h/4'h/5'h/6'h
 20'w x 2'h/3'h/4'h/5'h/6'h

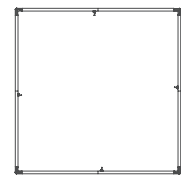

double sided graphic



bottom graphic

TAPERED SQUARE

8'w x 2'h/3'h/4'h/5'h/6'h
 10'w x 2'h/3'h/4'h/5'h/6'h
 12'w x 2'h/3'h/4'h/5'h/6'h
 14'w x 2'h/3'h/4'h/5'h/6'h
 16'w x 2'h/3'h/4'h/5'h/6'h
 18'w x 2'h/3'h/4'h/5'h/6'h
 20'w x 2'h/3'h/4'h/5'h/6'h

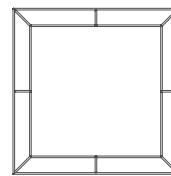

double sided graphic



certain shapes and sizes also available for rent



Formulate Master hanging structures are made in the USA and have a limited lifetime hardware warranty.

CONCAVE SQUARE

- 8'w x 2'h/3'h/4'h/5'h/6'h
- 10'w x 2'h/3'h/4'h/5'h/6'h
- 12'w x 2'h/3'h/4'h/5'h/6'h
- 14'w x 2'h/3'h/4'h/5'h/6'h
- 16'w x 2'h/3'h/4'h/5'h/6'h
- 18'w x 2'h/3'h/4'h/5'h/6'h
- 20'w x 2'h/3'h/4'h/5'h/6'h



TRIANGLE

- 8'w x 2'h/3'h/4'h/5'h/6'h
- 10'w x 2'h/3'h/4'h/5'h/6'h
- 12'w x 2'h/3'h/4'h/5'h/6'h
- 14'w x 2'h/3'h/4'h/5'h/6'h
- 16'w x 2'h/3'h/4'h/5'h/6'h
- 18'w x 2'h/3'h/4'h/5'h/6'h
- 20'w x 2'h/3'h/4'h/5'h/6'h

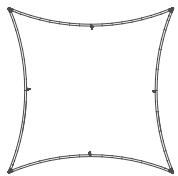

double sided graphic

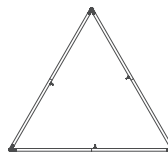

double sided graphic



bottom graphic

TAPERED TRIANGLE

- 8'w x 2'h/3'h/4'h/5'h/6'h
- 10'w x 2'h/3'h/4'h/5'h/6'h
- 12'w x 2'h/3'h/4'h/5'h/6'h
- 14'w x 2'h/3'h/4'h/5'h/6'h
- 16'w x 2'h/3'h/4'h/5'h/6'h
- 18'w x 2'h/3'h/4'h/5'h/6'h
- 20'w x 2'h/3'h/4'h/5'h/6'h



CONVEX TRIANGLE (SHIELD)

- 8'w x 2'h/3'h/4'h/5'h/6'h
- 10'w x 2'h/3'h/4'h/5'h/6'h
- 12'w x 2'h/3'h/4'h/5'h/6'h
- 14'w x 2'h/3'h/4'h/5'h/6'h
- 16'w x 2'h/3'h/4'h/5'h/6'h
- 18'w x 2'h/3'h/4'h/5'h/6'h
- 20'w x 2'h/3'h/4'h/5'h/6'h

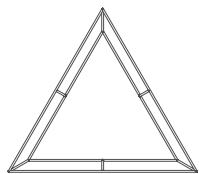

double sided graphic

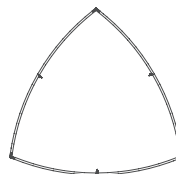

double sided graphic



OCE - Formulate Expandable Case

Structures collapse to a fraction of their size and come in standard carry bags and heavy-duty shipping and storage box(es).

Expandable, rugged molded shipping and transportation cases available as an upgrade.



certain shapes and sizes also available for rent



Formulate Master hanging structures are made in the USA and have a limited lifetime hardware warranty.

PINWHEEL

- 8'w x 2'h/3'h/4'h/5'h/6'h
- 10'w x 2'h/3'h/4'h/5'h/6'h
- 12'w x 2'h/3'h/4'h/5'h/6'h
- 14'w x 2'h/3'h/4'h/5'h/6'h
- 16'w x 2'h/3'h/4'h/5'h/6'h
- 18'w x 2'h/3'h/4'h/5'h/6'h
- 20'w x 2'h/3'h/4'h/5'h/6'h



double sided graphic

RECTANGLE

- 8'w x 2'h/3'h/4'h/5'h/6'h
- 10'w x 2'h/3'h/4'h/5'h/6'h
- 12'w x 2'h/3'h/4'h/5'h/6'h
- 14'w x 2'h/3'h/4'h/5'h/6'h
- 16'w x 2'h/3'h/4'h/5'h/6'h
- 18'w x 2'h/3'h/4'h/5'h/6'h
- 20'w x 2'h/3'h/4'h/5'h/6'h

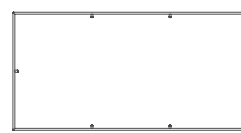

double sided graphic

FOOTBALL

- 8'w x 2'h/3'h/4'h/5'h/6'h
- 10'w x 2'h/3'h/4'h/5'h/6'h
- 12'w x 2'h/3'h/4'h/5'h/6'h
- 14'w x 2'h/3'h/4'h/5'h/6'h
- 16'w x 2'h/3'h/4'h/5'h/6'h
- 18'w x 2'h/3'h/4'h/5'h/6'h
- 20'w x 2'h/3'h/4'h/5'h/6'h

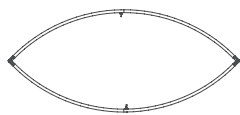

double sided graphic

FOUR-SIDED PYRAMID

- 10'w x 5'h
- 12'w x 6'h
- 16'w x 8'h
- 20'w x 10'h

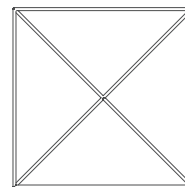

certain shapes and sizes also available for rent



Formulate Master hanging structures are made in the USA and have a limited lifetime hardware warranty.

CURVE

- 8'w x 2'h/3'h/4'h/5'h/6'h
- 10'w x 2'h/3'h/4'h/5'h/6'h
- 12'w x 2'h/3'h/4'h/5'h/6'h
- 14'w x 2'h/3'h/4'h/5'h/6'h
- 16'w x 2'h/3'h/4'h/5'h/6'h
- 18'w x 2'h/3'h/4'h/5'h/6'h
- 20'w x 2'h/3'h/4'h/5'h/6'h



PANEL

- 8'w x 2'h/3'h/4'h/5'h/6'h
- 10'w x 2'h/3'h/4'h/5'h/6'h
- 12'w x 2'h/3'h/4'h/5'h/6'h
- 14'w x 2'h/3'h/4'h/5'h/6'h
- 16'w x 2'h/3'h/4'h/5'h/6'h
- 18'w x 2'h/3'h/4'h/5'h/6'h
- 20'w x 2'h/3'h/4'h/5'h/6'h



DISC

- 8' diameter
- 10' diameter
- 12' diameter
- 14' diameter
- 16' diameter
- 18' diameter
- 20' diameter



S-CURVE

- 8'w x 2'h/3'h/4'h/5'h/6'h
- 10'w x 2'h/3'h/4'h/5'h/6'h
- 12'w x 2'h/3'h/4'h/5'h/6'h
- 14'w x 2'h/3'h/4'h/5'h/6'h
- 16'w x 2'h/3'h/4'h/5'h/6'h
- 18'w x 2'h/3'h/4'h/5'h/6'h
- 20'w x 2'h/3'h/4'h/5'h/6'h



THREE-SIDED PYRAMID

- 10'w x 5'h
- 12'w x 6'h
- 16'w x 8'h
- 20'w x 10'h

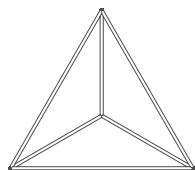

ROUND FUNNEL

- 10'w x 5'h

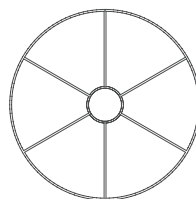

SQUARE FUNNEL

- 10'w x 5'h

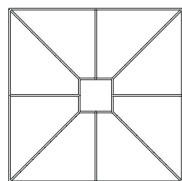

CONE

- 10'w x 5'h
- 12'w x 6'h
- 16'w x 8'h
- 20'w x 10'h

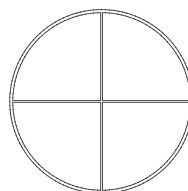

CUBE

- 3'w x 3'h
- 4'w x 4'h
- 6'w x 6'h
- 8'w x 8'h
- 10'w x 10'h

*illuminated cube also available

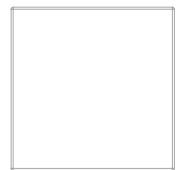

illuminated cube

ROUNDED SQUARE

- 8'w x 2'h/3'h/4'h/5'h/6'h
- 10'w x 2'h/3'h/4'h/5'h/6'h
- 12'w x 2'h/3'h/4'h/5'h/6'h
- 14'w x 2'h/3'h/4'h/5'h/6'h
- 16'w x 2'h/3'h/4'h/5'h/6'h
- 18'w x 2'h/3'h/4'h/5'h/6'h
- 20'w x 2'h/3'h/4'h/5'h/6'h

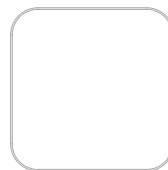

double sided graphic

FOUR-SIDED PINWHEEL

- 8'w x 2'h/3'h/4'h/5'h/6'h
- 10'w x 2'h/3'h/4'h/5'h/6'h
- 12'w x 2'h/3'h/4'h/5'h/6'h
- 14'w x 2'h/3'h/4'h/5'h/6'h
- 16'w x 2'h/3'h/4'h/5'h/6'h
- 18'w x 2'h/3'h/4'h/5'h/6'h
- 20'w x 2'h/3'h/4'h/5'h/6'h

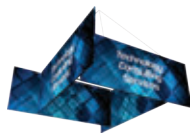
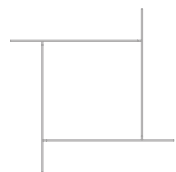

double sided graphic

HEXAGON

- 8'w x 2'h/3'h/4'h/5'h/6'h
- 10'w x 2'h/3'h/4'h/5'h/6'h
- 12'w x 2'h/3'h/4'h/5'h/6'h
- 14'w x 2'h/3'h/4'h/5'h/6'h
- 16'w x 2'h/3'h/4'h/5'h/6'h

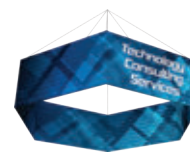
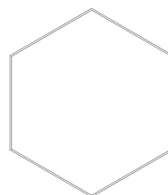

double sided graphic



NEW

EYE

- 8'w x 2'h/3'h/4'h/5'h/6'h
- 10'w x 2'h/3'h/4'h/5'h/6'h
- 12'w x 2'h/3'h/4'h/5'h/6'h
- 14'w x 2'h/3'h/4'h/5'h/6'h
- 16'w x 2'h/3'h/4'h/5'h/6'h

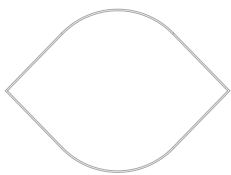

double sided graphic

ILLUMINATED 3D OVAL

- 10'w x 4'h
- 14'w x 6'h
- 18'w x 8'h

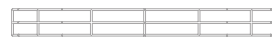

double sided graphic

ILLUMINATED CAPSULE

- 10'w x 4'h
- 14'w x 6'h
- 18'w x 8'h



double sided graphic

BULLET

- 10'w x 3'h
- 14'w x 4'h
- 18'w x 5'h

*tiered bullet also available



double sided graphic



TIERED BULLET



Formulate Master hanging structures are made in the USA and have a limited lifetime hardware warranty.

TIERED SQUARE

10'w x 5'h
 12'w x 5'h
 14'w x 5'h
 16'w x 5'h

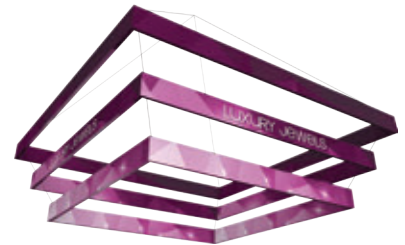
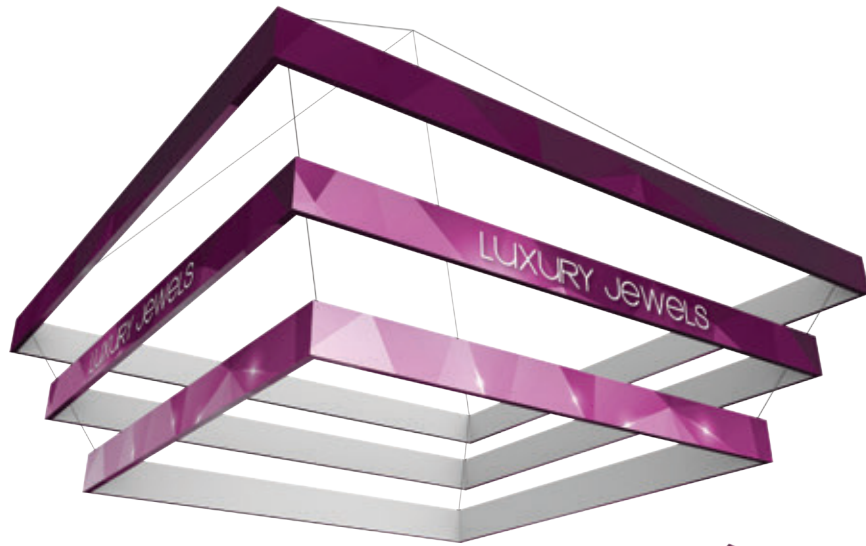
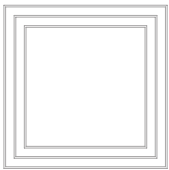

double sided graphic

SQUARE MOBILE

15'w x 13'h

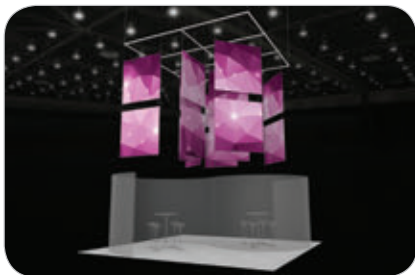
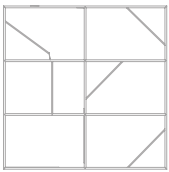



TIERED RING

- 10'diam. x 5'h
- 12'diam. x 5'h
- 14'diam. x 5'h
- 16'diam. x 5'h

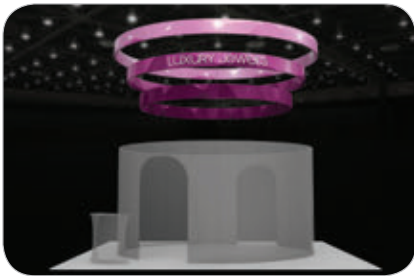
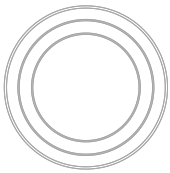

double sided graphic

TIERED RING FLAT

- 10'diam. x 38" h
- 12'diam. x 38" h
- 14'diam. x 38" h
- 16'diam. x 38" h

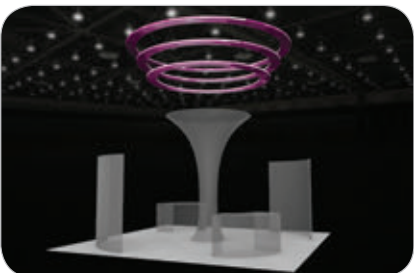
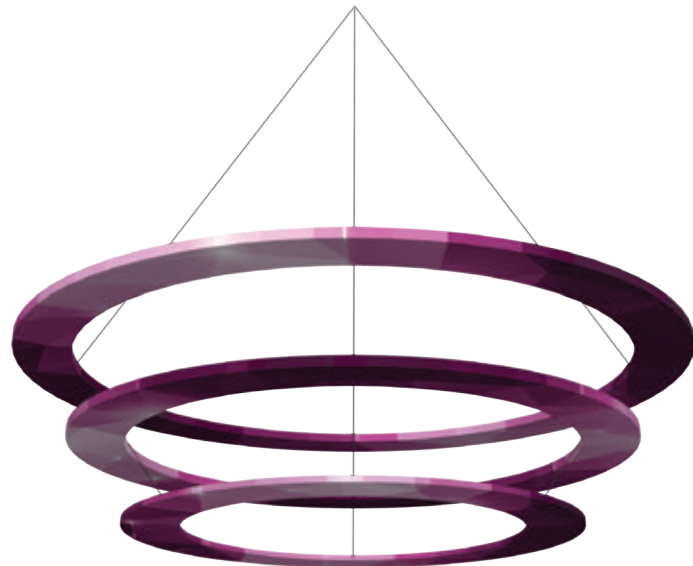
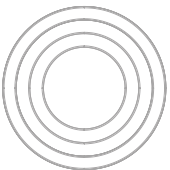

Formulate Designer Series hanging structures are made in the USA and have a limited lifetime hardware warranty.

FORMULATE FUNNELS

When you are looking for a way to draw attention and captivate your audience at a tradeshow, special event, or in a permanent environment, these Formulate™ tension fabric architectural structures are designed to impress.

Versatile Formulate Funnels transform any environment through form, fabric and lighting. Formulate Funnels have an hourglass shape, come in 20', 16' and 12' heights and have 8' diameters at the top and 3 ½' diameters at the bottom. Funnels feature a heavy-duty, wooden base and silver brushed coated truss interior to create a dynamic, towering structure that commands attention. Fabric graphics feature a zipper at the top and a silicone edge at the bottom for easy assembly. Accent LED light not included, but can be incorporated to add a glow within the funnel structures. Custom sizes also available.

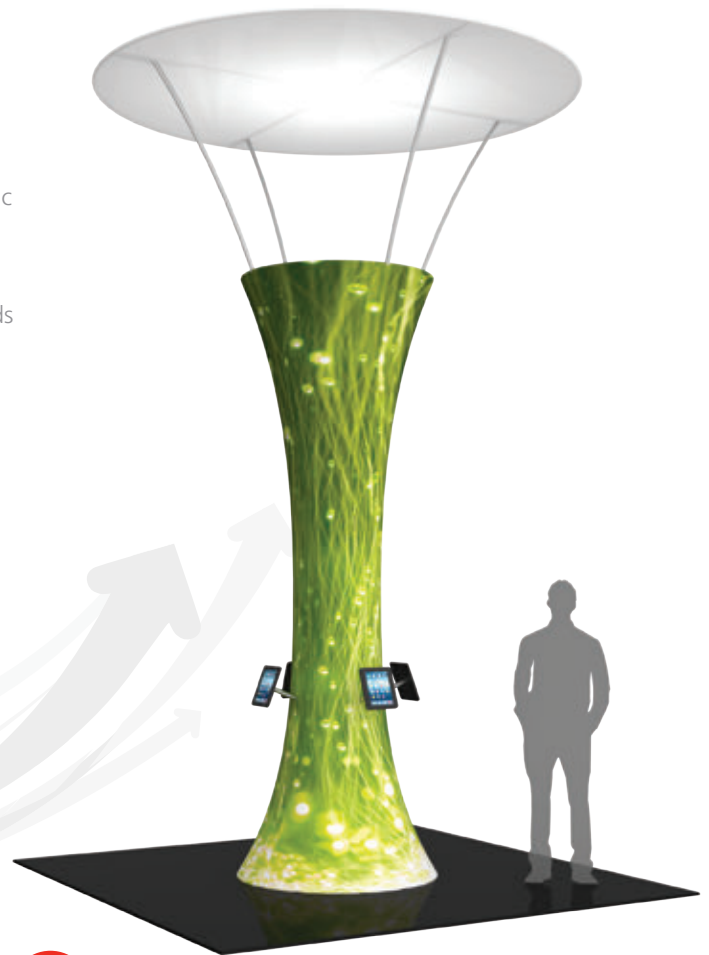

NEW 16' FUNNEL
FUN-04



20' FUNNEL
FUN-01



R 16' FUNNEL
FUN-02

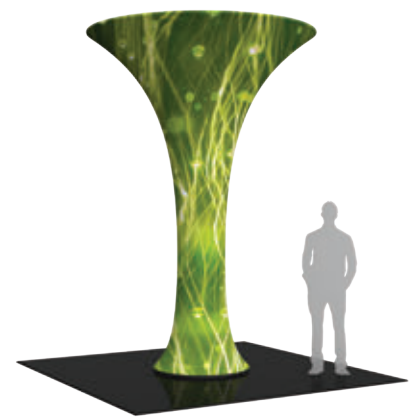

12' FUNNEL
FUN-03

*Tablets not included.

Formulate structures are made in the USA and a limited lifetime hardware warranty.



FORMULATE TOWERS

Mix and match the Formulate™ line of towers to add architecture and drama to any event or interior space. Cylinder-shaped, Rectangular-shaped and Shield-shaped towers come in 12', 10' and 8' heights and 3' square/diameters at the tops and bottoms. They combine the latest developments in fabric printed technology with aluminum tube frames to add dimension, décor and sculpture to any event, stage set, tradeshow booth or interior space. Formulate towers accommodate internal LED lighting. Accent LED light not included, but can be incorporated to add a glow within the structures. Custom sizes also available.

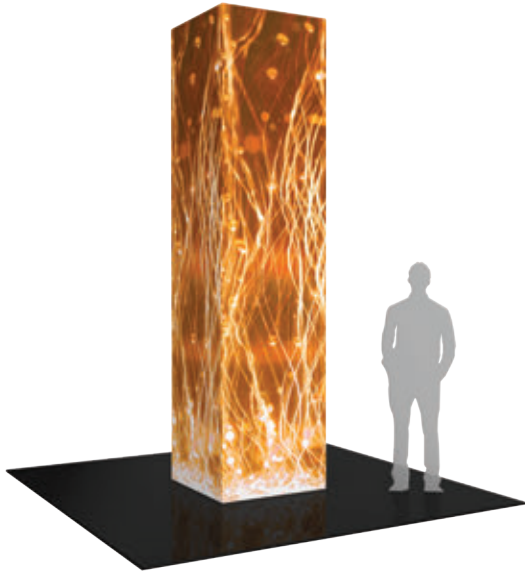

12' FOUR SIDED TOWER
CYL-01

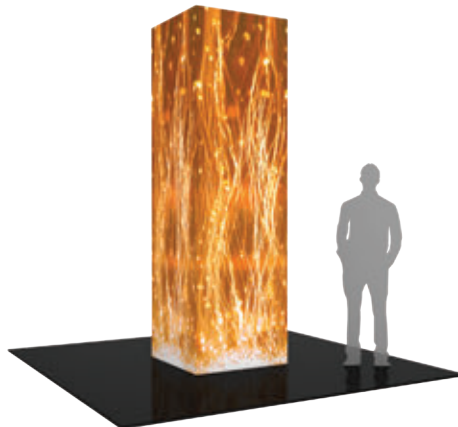

10' FOUR SIDED TOWER
CYL-02



8' FOUR SIDED TOWER
CYL-03

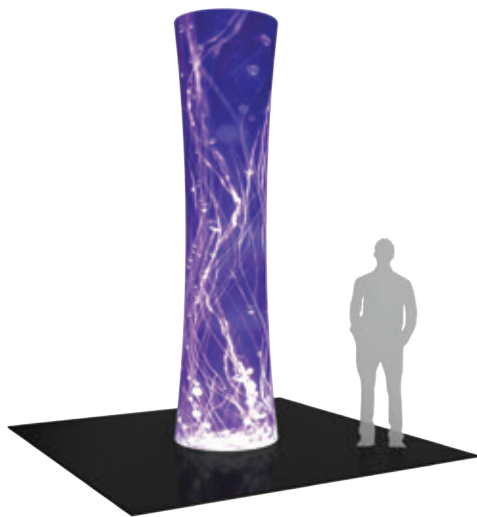

12' CYLINDER TOWER
CYL-01



10' CYLINDER TOWER
CYL-02

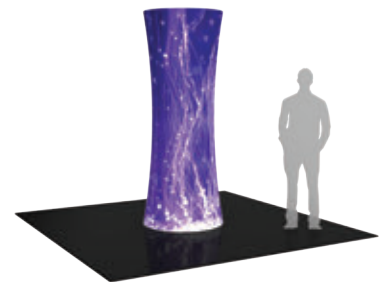

8' CYLINDER TOWER
CYL-03



Formulate structures are made in the USA and a limited lifetime hardware warranty.



FORMULATE TOWERS

When you are looking for a way to draw attention and captivate your audience at a tradeshow, special event, or in a permanent environment, these Formulate™ tension fabric architectural structures are designed to impress.

Mix and match the Formulate line of towers to add architecture and drama to any event or interior space. Cylinder, Rectangular and Shield-shaped towers come in 12', 10' and 8' heights and 3' square/diameters at the tops and bottoms.



10' TOWER
TOWER-01*

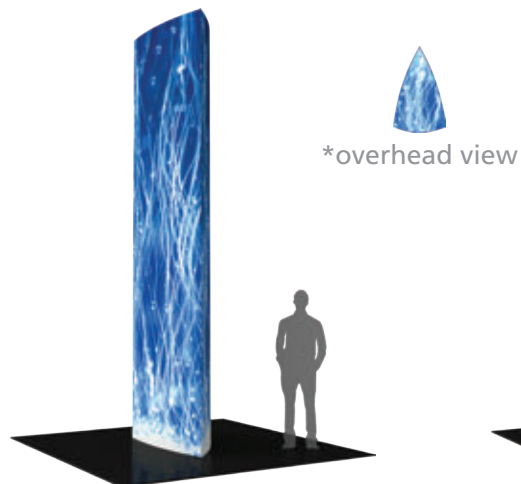

12' SHIELD TOWER
SHD-TOWER-03

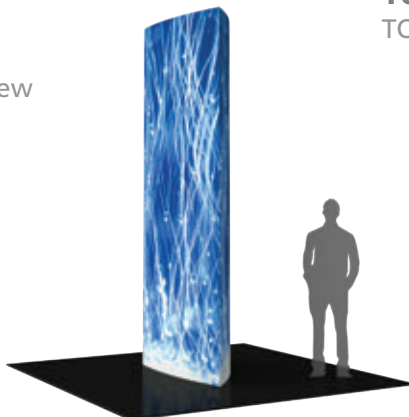

10' SHIELD TOWER
SHD-TOWER-02

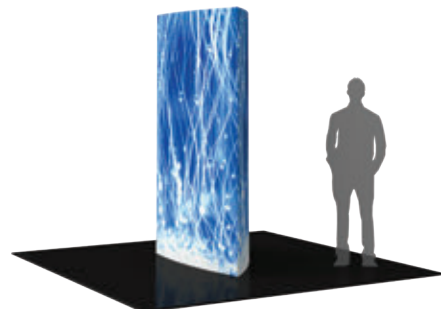

8' SHIELD TOWER
SHD-TOWER-01

INFLATABLE COLUMNS

This free-standing inflatable column is great for indoor and outdoor use and can be customized with your own graphics. The hollow plastic base can be filled with water or sand for added stability. Ground stakes are sold separately.



LARGE INFLATABLE COLUMN
INF-COL-L



MEDIUM INFLATABLE COLUMN
INF-COL-M



SMALL INFLATABLE COLUMN
INF-COL-S

*Monitor not included.



BROWSE OUR FULL LINE OF **PORTABLE EXHIBITS & DISPLAYS** IN THE PORTABLE CATALOG



Banner Stands, p.2



Outdoor Displays, p.24



Hopup™ Tension Fabric Displays, p.38



Embrace™ Push-Fit Fabric Displays, p.44



Coyote™ Popup Displays, p.56



Display Accents & Accessories, p.66

FORMULATE ARCHES

Formulate™ Arches add architecture and design to any event or interior space! Easily create and define a stunning entryway, focal point or stage set at your next tradeshow or event with Formulate Arches.

Formulate Arches combine pillowcase style stretch fabric graphics with curved aluminum tube frames; these super structures are made in the USA and collapse to a fraction of their size. Custom sizes also available.

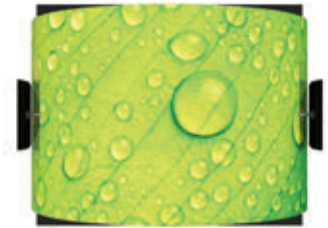

overhead perspective

ARCH 01 12'
ARCH-01

The Formulate Arch 01 is 8' tall, spans 11 ½' wide and is nearly 8' deep at the bases. Two monitor mounts are included, externally facing, adding a bonus opportunity to display messaging and branding. Shown in a 12' space.

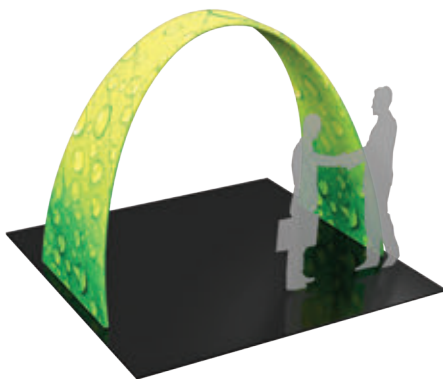

ARCH 02 10'
ARCH-02

The Formulate Arch 02 is 7 ⅔' tall, spans 9 ½' wide and is nearly 5' deep at the bases. Shown in a 10' space.

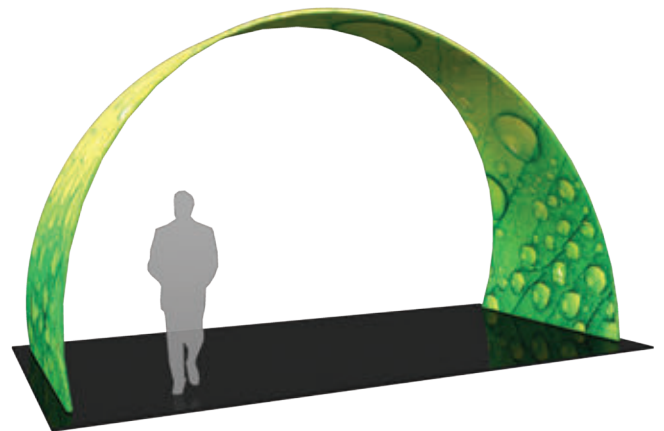

ARCH 03 20'
ARCH-03

The Formulate Arch 03 is 11 ½' tall, spans 19 ½' wide and is 8' deep at the bases. The Arch fits perfectly in a 20' x 20' island space. Shown in a 20' space.

*Monitor not included.

Formulate structures are made in the USA and a limited lifetime hardware warranty.



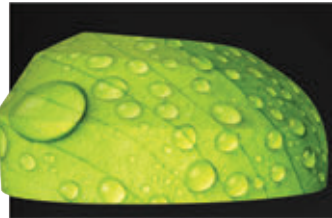
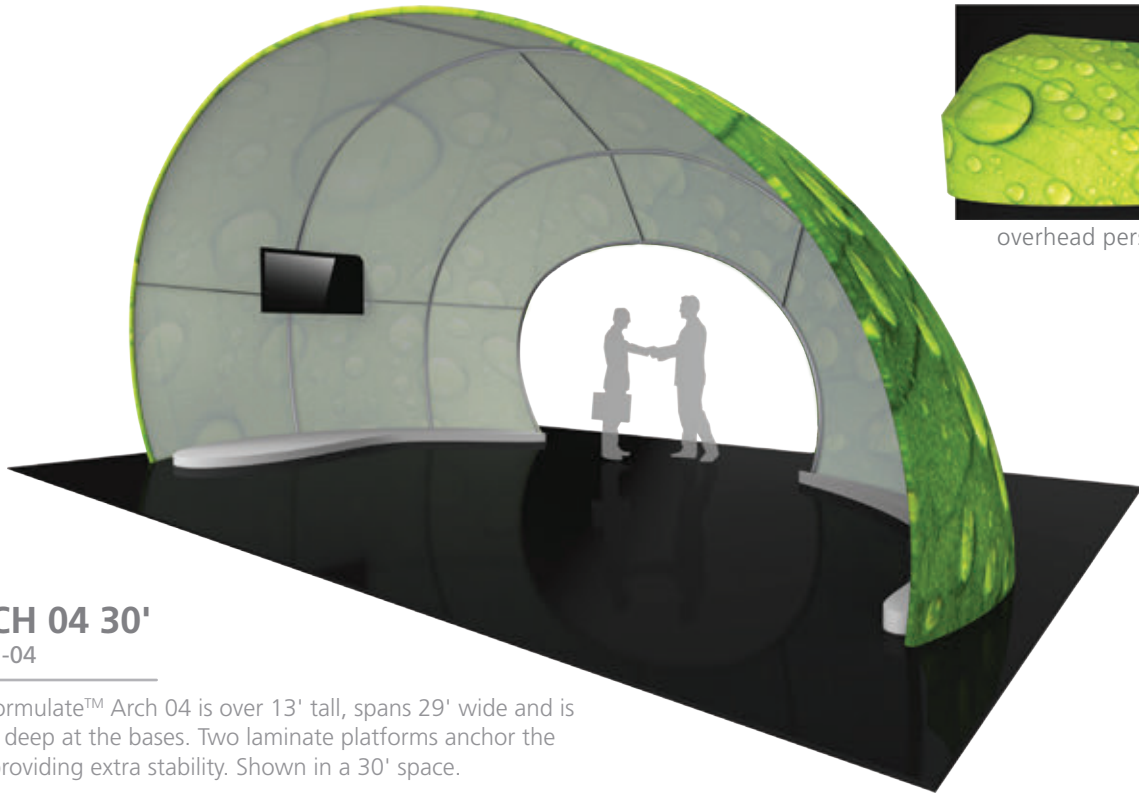

overhead perspective

ARCH 04 30'

ARCH-04

The Formulate™ Arch 04 is over 13' tall, spans 29' wide and is 13 ½' deep at the bases. Two laminate platforms anchor the arch providing extra stability. Shown in a 30' space.

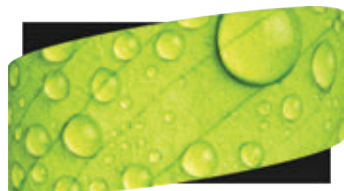
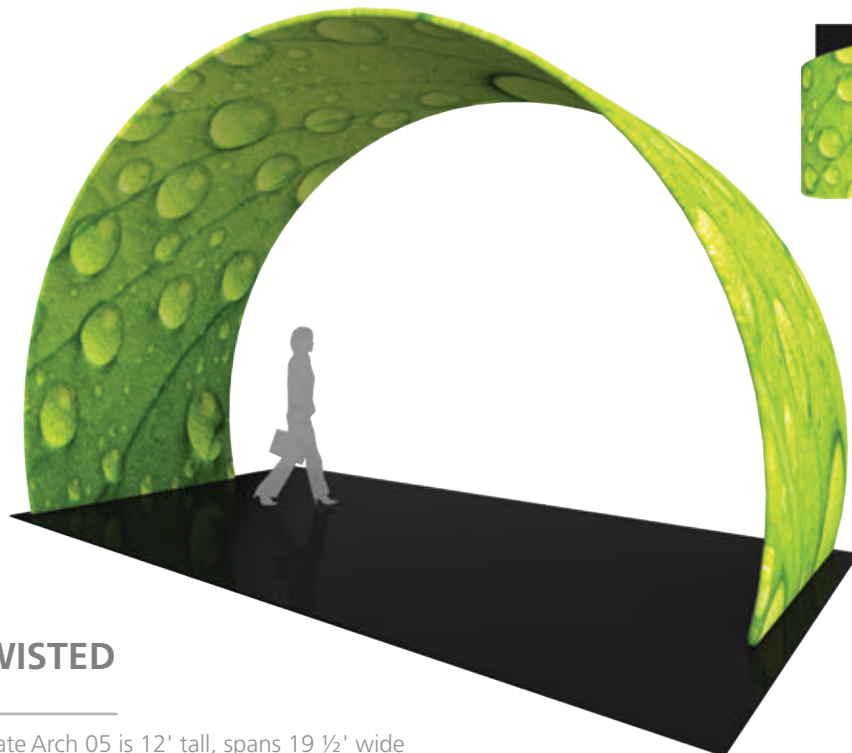

overhead perspective

ARCH 05 TWISTED

ARCH-05

The Twisted Formulate Arch 05 is 12' tall, spans 19 ½' wide and is 10' deep at the bases. The twisted shape provides a unique style element. Shown in a 20' space.

*Monitor not included.

FORMULATE
CONFERENCE WALLS

Whether you are looking to create a semi-private meeting area within a tradeshow exhibit, special event, or in an interior environment, Formulate™ tension fabric conference walls are lightweight, stylish solutions to your meeting space needs.

Ergonomically designed, Formulate C-shaped, Chip-shaped and Serpentine-shaped walls combine the latest developments in fabric printed technology with gently curved 50mm aluminum frames to create private, cozy and stylish conference areas within any space.

C-SHAPED WALL
C-WALL

The Formulate C-Wall stands 7' tall at its highest point and is 7' 4" diameter. Perfect for a small table and chairs or benches for seating, this mini-conference area combines function and flare to create a stylish, semi-private space.

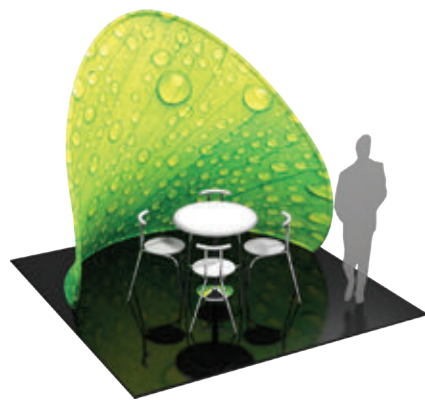

CHIP-SHAPED WALL
CHIP-WALL

The Formulate Chip-Shaped Wall is a potato chip shaped structure that stands 8' tall and is 9' 3" wide. It is an ideal structure to create a semi-private conference/meeting area or projection wall within a space.



CHIP-SHAPED WALL
CHIP-WALL-02

The Formulate Chip Wall 02 is a curved conference room divider that stands 6' 4" tall and is 9' 5" wide. It is an ideal structure to create a semi-private conference/meeting area or projection wall within a space.

*Furniture not included.

Formulate structures are made in the USA and a limited lifetime hardware warranty.



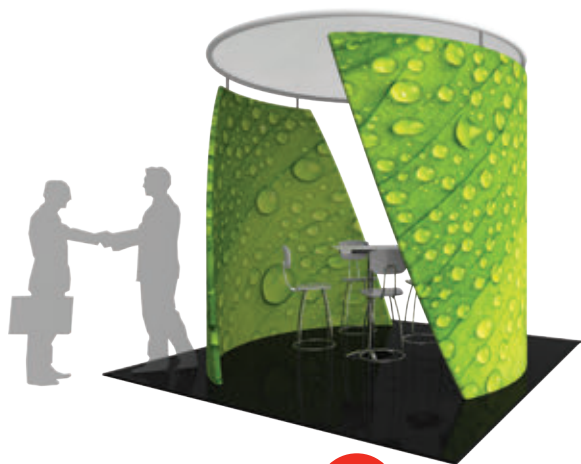

CONFERENCE WALL
C-WALL-02 **NEW**

The Formulate™ standalone conference room features two fabric walls and a sheer fabric canopy to create a stylish semi-private conference space. The conference room is large enough to house a small table and four chairs. Conference Wall 02 is 8'6" tall and has a diameter of 9'. Furniture not included.

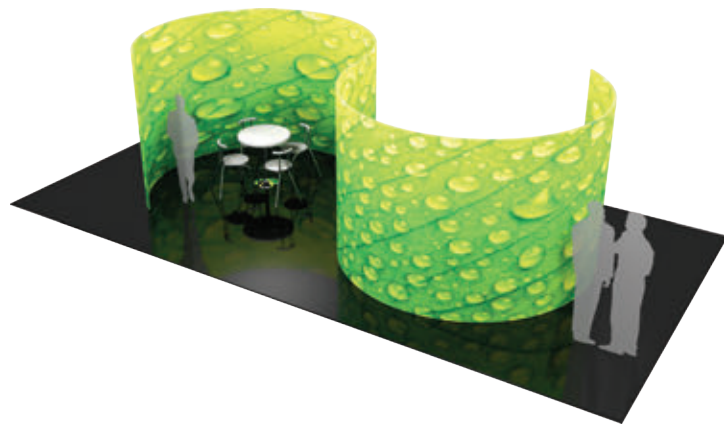

SERPENTINE WALL
S-WALL

The Formulate Serpentine shaped wall connects two C-shaped structures to create a multipurpose, Serpentine shaped display. The Serpentine Wall is ideally used as a wall that separates two mini-conference and meeting areas. The Formulate Serpentine Wall is 7' 7" tall and spans 22' 10" wide – perfect for use in a large island space. Furniture not included.

FORMULATE VIDEO WALLS & ROOMS

Heavy-duty 50mm aluminum frames are coupled with stretch, zipper pillowcase fabric graphics to create flowing, uniquely-shaped Formulate curved walls and architectural structures that are ideal for tradeshow, events, corporate environments and interior spaces. With a variety of options, you can mix and match with other Formulate fabric structures to create the ideal display, booth or environment. Custom sizes also available.

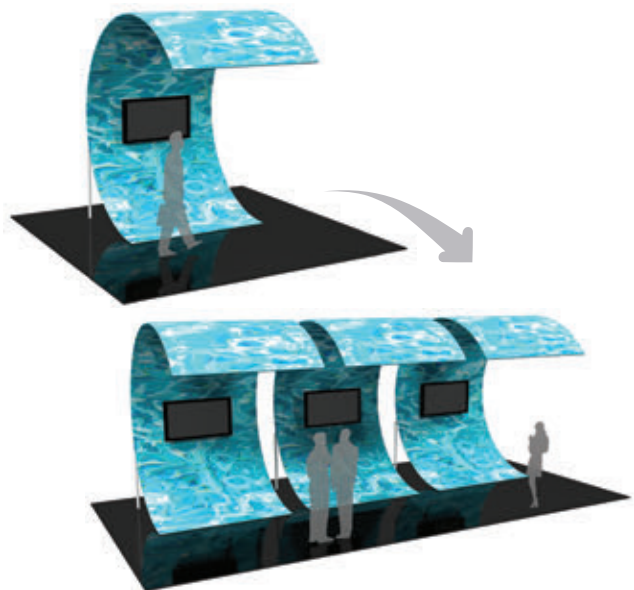

SURF
SURF-WALL

The Formulate Surf Wall is a C-shaped multimedia display that stands 11' 4" tall with a width of 7' 7". With an organic, curved shape sustained by supporting legs, and a monitor mount for a monitor/TV, the Surf makes a distinctive statement in any space.



TREE HOUSE **R**
TREEHOUSE-RM

The Formulate Tree House is a cylinder-shaped space perfect for meetings, graphical displays, projected presentations, a theater setting and much more. The Tree House is 15' in diameter, 8' tall and features two 7' tall doorways, encouraging traffic flow through the structure.

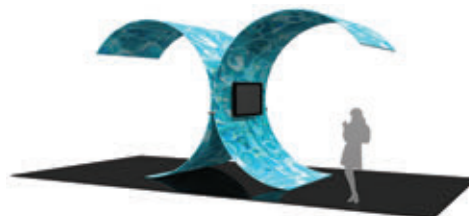

TREE
TREE

Two C-shaped structures are fused together to create a Tree shape with this sculptural, multimedia display. The Formulate Tree stands 11' 4" tall and spans to 20' 6" wide. The Formulate Tree includes two monitor mounts for use as a multimedia display.

*Monitor and furniture not included.



Hybrid Pro Modular
Kit 03
HP-K-03



Hybrid Pro Modular Kit 03, p.160



Hybrid Pro Modular Kit 11, p.162



Vector Frame Light Box, p.172

MODULAR **EXHIBIT** SYSTEMS

Modular exhibit systems and displays provide exhibitors with sophisticated, custom-looking exhibits that stand the test of time, and can adapt and evolve from show to show. Using standardized components as building blocks, modular displays can often be reconfigured to fit multiple size spaces and customized to fit unique needs.

Modular displays are used in tradeshow and events, and are often used as permanent displays in museums and educational environments and in retail settings.

Many of our modular exhibit systems combine aluminum extrusion frames with push-fit fabric graphics. USA-made modular exhibit systems are created by expert welding and metal-working technicians. Graphics are printed with the latest state-of-the-art large format printers, and all graphics are produced and finished by hand by highly-skilled sewers in the USA.

Our variety of modular display systems offer displays of many types and sizes, from banners and light boxes to table-top displays, through to 10' and 20' inline exhibit kits, as well as 20' by 20' island exhibit kits. Display accent pieces and accessories such as charging stations, counters, multi-media kiosks, lighting and more help add functionality and the final finishing touches.

BOLD EXHIBITS, MADE **INGENIOUSLY** SIMPLE.



Magellan Orbital Express Truss, p.203



Hybrid Pro Modular Kit 19, p.166

hybrid pro™ modular | EXHIBIT KITS



HYBRID PRO KIT 01
HP-K-01



HYBRID PRO MODULAR

The sophisticated, striking appearance of Hybrid Pro™ Modular exhibits takes exhibiting to a new level.

The Hybrid Pro Modular series is a collection of modular and reconfigurable exhibit backwalls and counters that feature heavy-duty aluminum frames, push-fit fabric graphics and high-end features such as tables, monitor mounts, interior LED lighting and more. The intricacy of the details makes these exhibits impossible not to notice.

Versatile inline 10' x 20' Hybrid Pro Modular displays reconfigure to 10' x 10' versions, increasing the value and lifecycle of the exhibit, as well as the investment. Counters can be mixed and matched and are often used for non-tradeshow applications as well; the quality is like a custom-made furniture piece!

All Hybrid Pro Modular display frames are quality crafted and manufactured in the USA. All push-fit and pillowcase fabric graphics are produced in the USA, printed on state-of-the-art, G7 color certified printers and are finished by hand.

MAXIMIZE YOUR INVESTMENT AND IMPACT WITH A HYBRID PRO MODULAR DISPLAY!

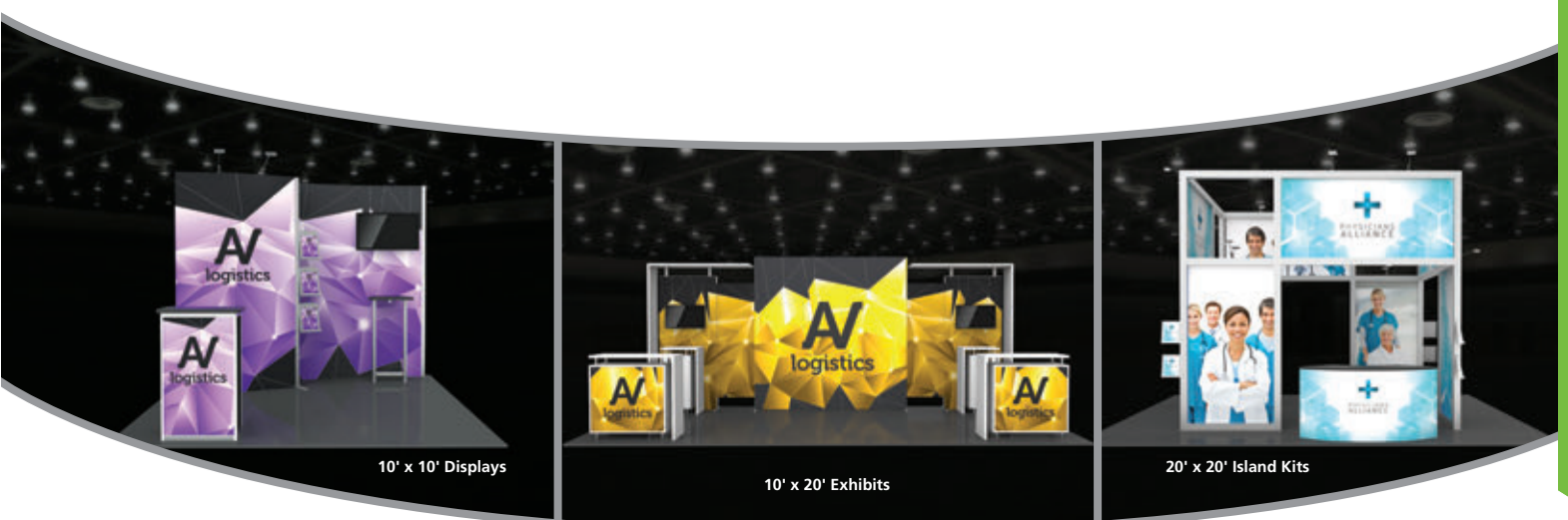

hybrid pro™ modular | 10' EXHIBIT KITS

HYBRID PRO 10' MODULAR BACKWALLS

If you are a serious exhibitor looking to make a lasting impression with a sophisticated, feature-rich exhibit, the Hybrid Pro™ Modular line of exhibits, counters and accessories will help you make a big splash. The Hybrid Pro line of modular exhibits feature heavy-duty aluminum extrusion frames and easy-to-apply silicone edge push-fit fabric graphics.



KIT 01
HP-K-01

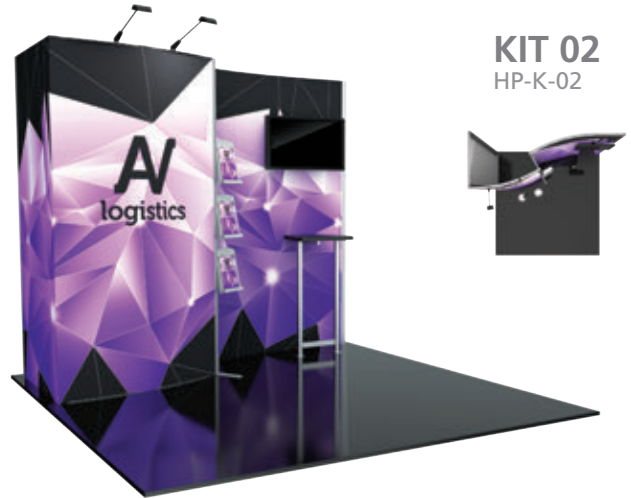

KIT 02
HP-K-02

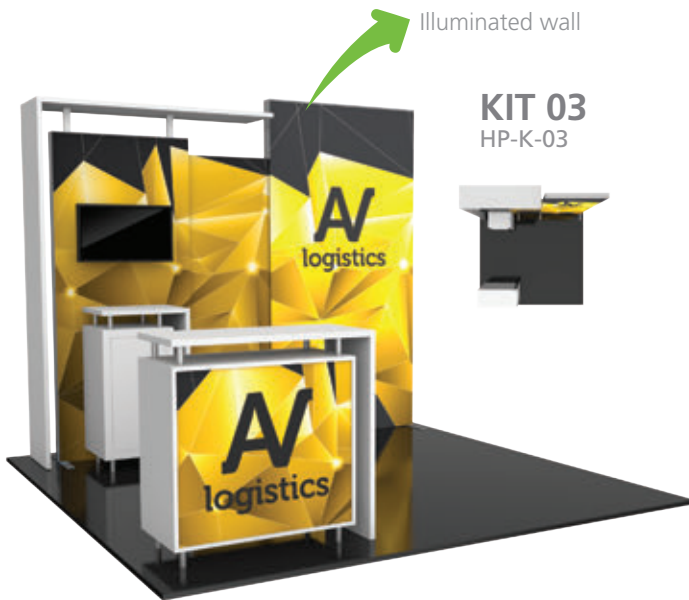

KIT 03
HP-K-03

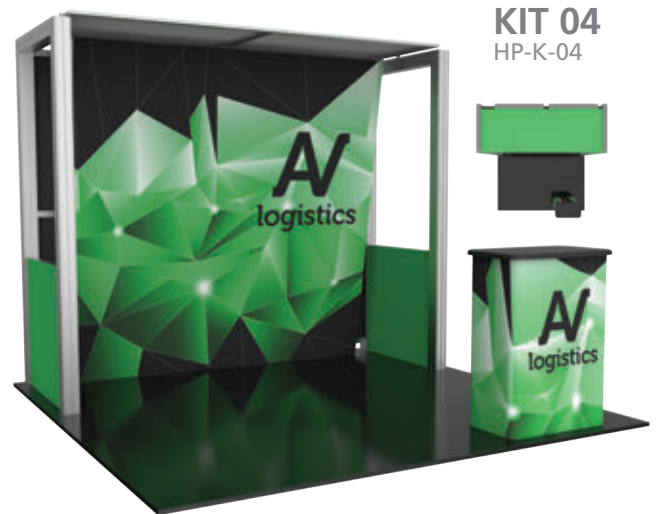

KIT 04
HP-K-04



easy to apply push-fit fabric graphics



10' EXHIBIT KITS | hybrid pro™ modular



All Hybrid Pro Modular kits are also available for rent

KIT 05
HP-K-05

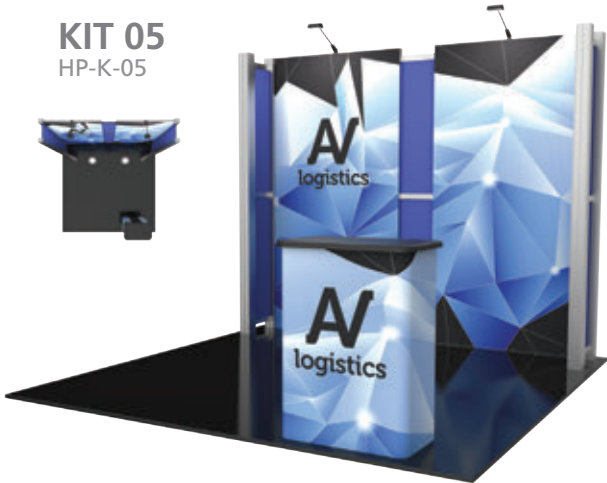

KIT 06
HP-K-06

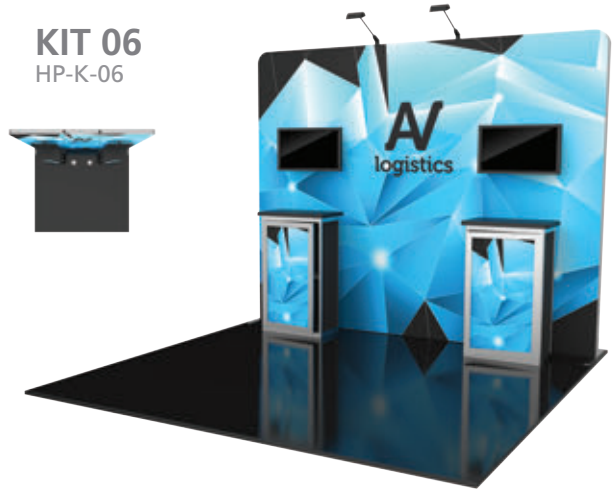

KIT 07
HP-K-07



KIT 08
HP-K-08

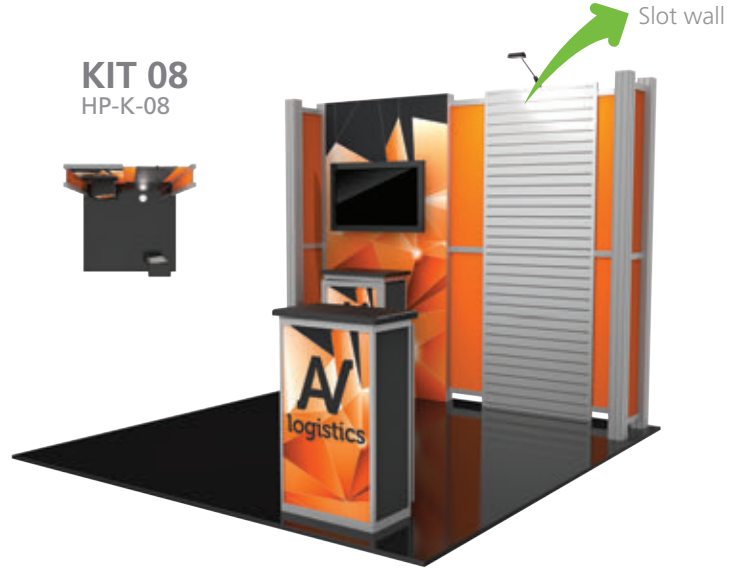

Hybrid Pro counter tops are available in your choice of four thermoform finishes



Counters featured on p.168

*Monitors not included.

Counters featured in foreground sold separately; see pages 168-169 for options.

hybrid pro™ modular | 20' EXHIBIT KITS

HYBRID PRO 20' MODULAR BACKWALLS

If you are a serious exhibitor looking to make a lasting impression with a sophisticated, feature-rich exhibit, the Hybrid Pro™ Modular line of exhibits, counters and accessories will help you make a big splash. The Hybrid Pro line of modular exhibits feature heavy-duty aluminum extrusion frames and easy-to-apply silicone edge push-fit fabric graphics.

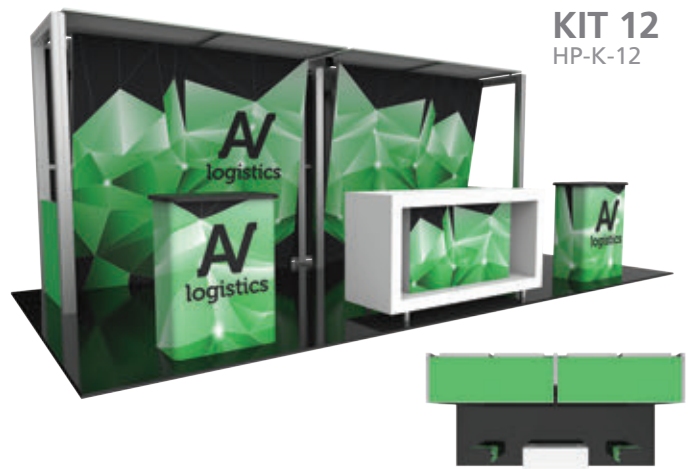
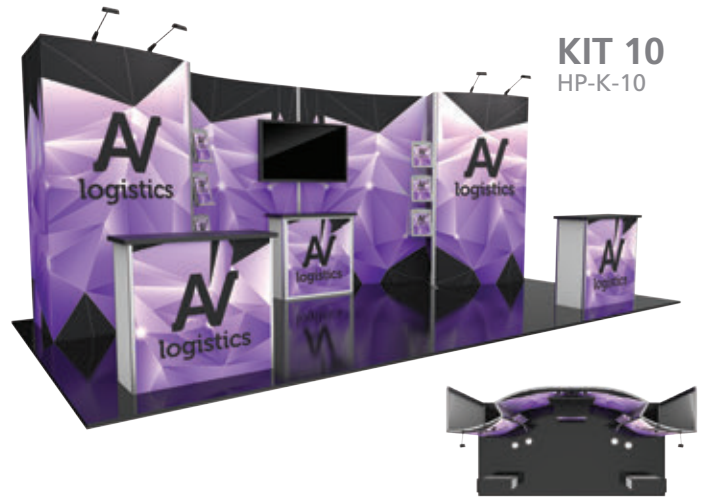
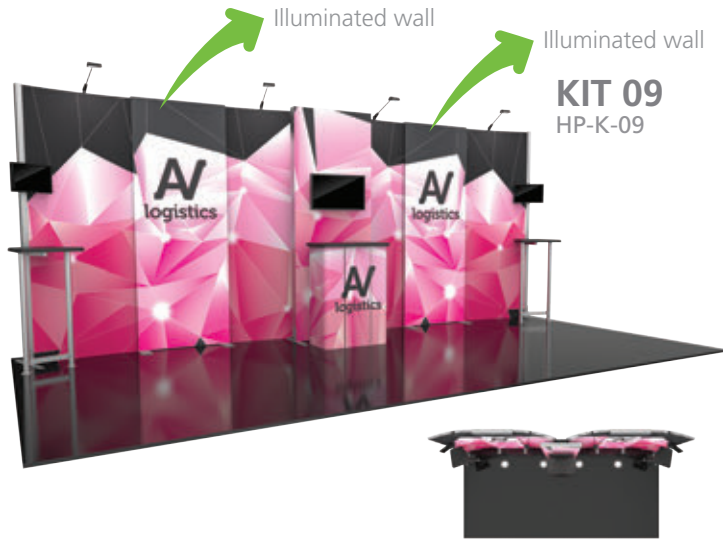

easy to apply push-fit fabric graphics



All Hybrid Pro Modular displays are made in the USA and come with a limited lifetime hardware warranty.

20' EXHIBIT KITS | hybrid pro™ modular



All Hybrid Pro Modular kits are also available for rent

KIT 13
HP-K-13

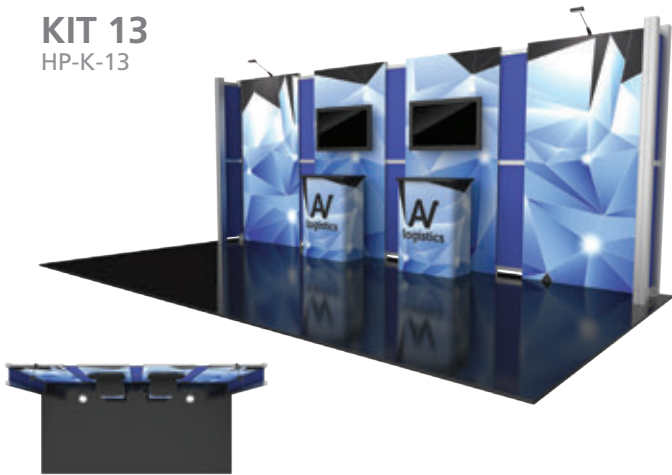

KIT 14
HP-K-14

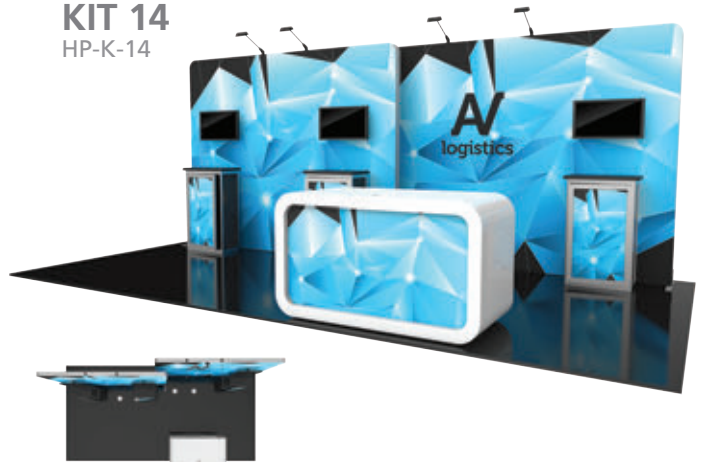

KIT 15
HP-K-15

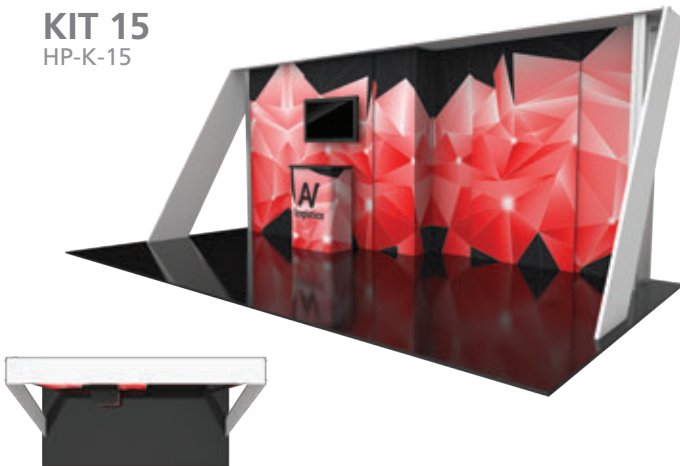

KIT 16
HP-K-16

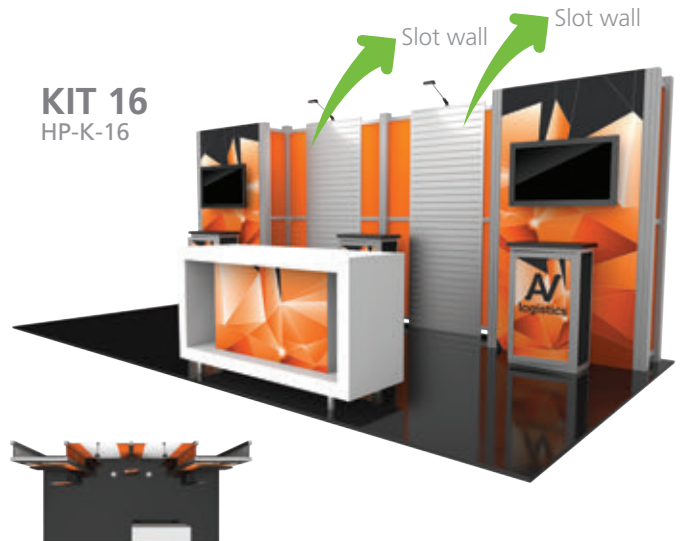

Counters featured on p.168

Hybrid Pro counter tops are available in your choice of four thermoform finishes



silver black mahogany natural

*Monitors not included.

Counters featured in foreground sold separately; see pages 168-169 for options.

hybrid pro™ modular | 20' x 20' ISLAND EXHIBIT KITS

Hybrid Pro™ Modular island exhibit kits provide an unparalleled dynamic that elevates and accentuates a message and brand, but also maximizes the return on tradeshow investment. Hybrid Pro Modular is a collection of 20' x 20' exhibit kits and custom solutions. Heavy-duty aluminum is coupled with dynamic graphics to create sophisticated, commanding and unforgettable island spaces. All Hybrid Pro Modular exhibits and graphics are made in the USA.



Isometric View

HYBRID PRO MODULAR KIT 17

HP-K-17

Attract visitors and broadcast your brand atop the tall fabric tower structure of this exhibit. Hybrid Pro™ Modular Kit 17 features a variety of bells and whistles that make the structure perfect for engagement and demonstrations. Stylish aluminum hardware is combined with white laminate panels, printed rigid graphics and stretch fabric graphics to create a presence on the show floor that will absolutely turn heads!

The tower structure stands 15' 9" tall and sits in a corner of the 20' x 20' space. Three demonstration/work stations provide generous counter space, back-to-back monitor mounts to hold TVs/LCD screens, lots of accessible storage underneath and printed rigid graphics on which to feature your desired messaging. LCD monitors and flooring not included.

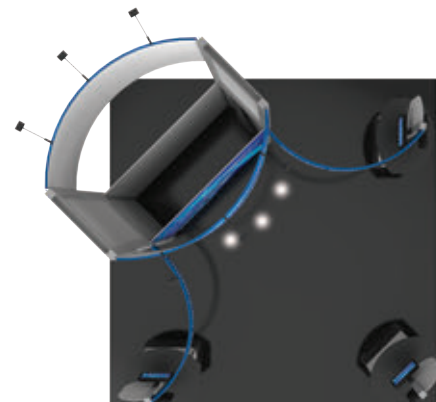

Overhead View



Isometric View

HYBRID PRO MODULAR KIT 18

HP-K-18

Wow your clients with a modern island structure that features state-of-the-art-printed fabric graphics. Hybrid Pro™ Modular Kit 18 features an 11' 10" tall square shaped structure that comes with a number of features that dress and accessorize.

Sleek aluminum hardware is combined with double sided push-fit fabric graphics to inform visitors of your desired brand and message. The optional front reception counter and the interior counter (part of kit rental) provide accessible and lockable storage. Flooring not included.

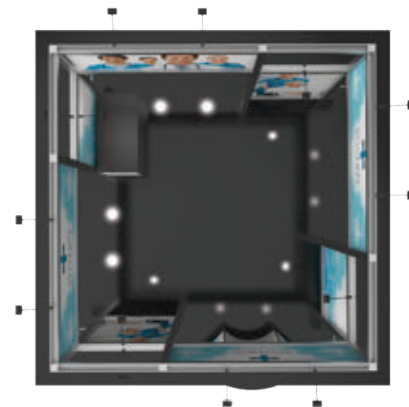

Overhead View

hybrid pro™ modular | 20' x 20' ISLAND EXHIBIT KITS



Isometric View

HYBRID PRO MODULAR KIT 19

HP-K-19

Rise above the competition with tall fabric graphic towers. Mounted monitors, accent lighting, an open floor-plan and semi-private meeting areas are some of the highlights of this dynamic display. Hybrid Pro™ Modular Kit 19 features four commanding walls that stand 15 '9" tall with double sided push-fit fabric graphics 8' square, helping to make your brand and message stand higher than the rest!

Hybrid Pro Modular Kit 19 features many areas to display media, TVs/LCD screens, two semi-private meeting alcoves with curved frosted plex infills and a small storage room in the center of the structure. **Front reception counter, LCD monitors and flooring not included.**

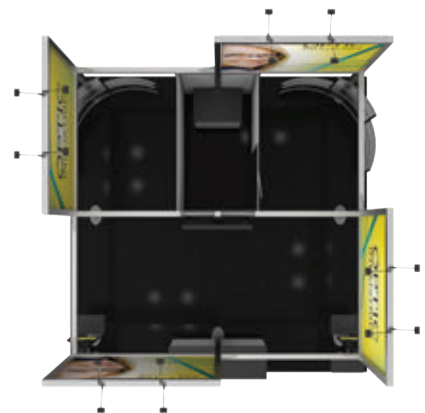

Overhead View



Isometric View

HYBRID PRO MODULAR KIT 20

HP-K-20

Dominate the tradeshow floor with a buttress-style exhibit, featuring curved corner heavy-duty white laminated wood structures, fabric graphic walls, accents and an open center area perfect for meetings and seating. Hybrid Pro™ Modular Kit 20 stands approximately 14' tall and features over eight areas to display messaging, media and/or products.

The overhead 12'd x 4'h circular ring structure features purchased single or double sided printed pillowcase fabric graphics to draw in visitors with your brand and message. Front reception counter, LCD monitors and flooring not included.



Overhead View

*Monitor and furniture not included.

hybrid pro™ modular | COUNTERS

HYBRID PRO COUNTERS

All Hybrid Pro™ Modular counters feature accessible storage and locking doors. Printed fabric graphics or rigid infill panels allow for your messaging and branding. Choose the size and counter shape that will match your backwall and space best.



Hybrid Pro Counter 01
39.38" w x 39.38" h x 17.75" d
HPC-01

- white laminate cabinet with fabric graphic on the front, opaque or backlit



Hybrid Pro Counter 02
70.88" w x 39.38" h x 23.63" d
HPC-02

- white laminate cabinet with fabric graphic on the front, opaque or backlit



Hybrid Pro Counter 03
39.38" w x 36.63" h x 15.75" d
HPC-03

- white laminate panel cabinet with UV graphic on the front and laminate top



Hybrid Pro Counter 04
73.75" w x 36.5" h x 25.38" d
HPC-04

- white laminate panel cabinet with UV graphic on the front and laminate top



COUNTERS | hybrid pro™ modular

Select Hybrid Pro counter tops are available in your choice of four laminate colors



All Hybrid Pro Modular counters are also available for rent



Hybrid Pro Counter 09
46" w x 37.5" h x 23" d
REC-42

- white laminate cabinet with UV graphic on the front, opaque or backlit



Hybrid Pro Counter 10
64" w x 37.5" h x 30" d
REC-52

- white laminate cabinet with UV graphic on the front, opaque or backlit



Hybrid Pro Counter 11
71.06" w x 36.61" h x 32.72" d
RCK-06

- white laminate panel cabinet with UV graphic on the front and laminate top





VECTOR FRAME **GEOMETRIC**

The innovative, contemporary and clean appearance of the Vector Frame™ line of geometric displays will captivate and **WOW** your audience.

The Vector Frame series is a collection of geometric shaped backwalls, banners, exhibit kits, counters and light boxes that feature durable, easy-to-assemble aluminum extrusion frames and push-fit fabric graphics. Vector Frame exhibit kits come with accent lighting, tables, counters, literature accessories, monitor mounts and interior LED edge lighting where indicated.

Vector Frame can be reconfigured and customized to create completely tailored exhibits and interior display solutions.

All Vector Frame display frames are quality crafted and manufactured in the USA. All push-fit fabric graphics are produced in the USA, printed on state-of-the-art, G7 color certified printers and are finished by hand.

You will certainly make a strong and lasting impression with Vector Frame exhibits, counters and light boxes at your tradeshow or event.

MAKE AN IMPACT WITH A **CLEAN,** **CONTEMPORARY** FABRIC DISPLAY.

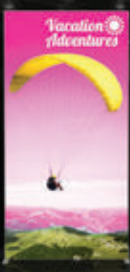

Banners



Light Boxes



Essential Kits



Master Kits

VECTOR FRAME LIGHT BOXES

Vector Frame™ fabric light boxes feature durable 4" aluminum extrusion frames, push-fit INTENSITY backlit fabric graphics and LED edge lighting. Single and double sided graphic options are available.



LIGHT BOXES



01 Square
VF-LB-S-01
36.3" w x 35.68" h x 19.69" d
comes in 1 OCE case



02 Rectangle
VF-LB-R-02
36.3" w x 71.12" h x 19.69" d
comes in 1 OCH case

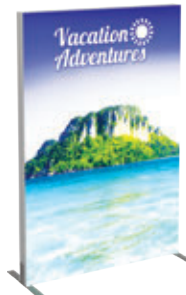

03 Rectangle
VF-LB-R-03
48.11" w x 71.12" h x 19.69" d
comes in 1 OCH case



05 Rectangle
VF-LB-R-05
118.99" w x 94.74" h x 19.69" d
comes in 1 OCH case



01 Square
VF-LB-S-01
36.3" w x 35.68" h x 19.69" d
comes in 1 OCE case



02 Square
VF-LB-S-02
48.11" w x 47.49" h x 19.69" d
comes in 1 OCE case



03 Square
VF-LB-S-03
71.73" w x 71.12" h x 19.69" d
comes in 1 OCH case



04 Square
VF-LB-S-04
95.35" w x 94.49" h x 19.69" d
comes in 1 OCH case



All Vector Frame displays are made in the USA and have a limited lifetime hardware warranty.

VECTOR FRAME BANNERS

Vector Frame™ banners combine aluminum extrusion frames with push-fit fabric graphics to create a versatile banner, backwall, hanging art or display. Vector Frame banners can be used to display messaging or art in a corporate environment or at a tradeshow and feature 2" aluminum extrusion frame and single or double sided graphics.



fits perfect in a 10' space

05 Rectangle
VF-R-05
118.98" w x 94.74" h x 19.69" d
comes in 1 OCL case



easy to apply push-fit fabric graphics

BANNERS



01 Rectangle
VF-R-01
36.3" w x 47.49" h x 19.69" d
comes in 1 OCL case



02 Rectangle
VF-R-02
36.3" w x 71.12" h x 19.69" d
comes in 1 OCS case



03 Rectangle
VF-R-03
48.11" w x 71.12" h x 19.69" d
comes in 1 OCL case

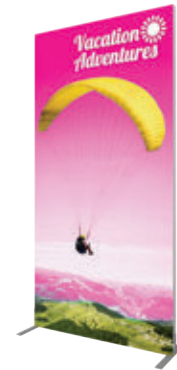

04 Rectangle
VF-R-04
48.11" w x 94.74" h x 19.69" d
comes in 1 OCL case



01 Square
VF-S-01
36.3" w x 35.68" h x 19.69" d
comes in 1 OCS case



02 Square
VF-S-02
48.11" w x 47.49" h x 19.69" d
comes in 1 OCL case



03 Square
VF-S-03
71.73" w x 71.12" h x 19.69" d
comes in 1 OCS case



04 Square
VF-S-04
95.35" w x 94.74" h x 19.69" d
comes in 1 OCL case



All Vector Frame displays are made in the USA and have a limited lifetime hardware warranty.

VECTOR FRAME CURVED BANNERS

Vector Frame™ curved banners combine 2" aluminum extrusion frames with push-fit fabric graphics to create a versatile single and double sided banner, backwall or interior display. Use as a concave or convex shape.



01 Curved Rectangle
VF-CR-01
39.33" w x 94.74" h x 19.69" d
comes in 1 OCL case



02 Curved Rectangle
VF-CR-02
56.75" w x 94.74" h x 19.49" d
comes in 1 OCL case



03 Curved Rectangle
VF-CR-03
68" w x 94.74" h x 18.75" d
comes in 1 OCE case

VECTOR FRAME MONITOR KIOSKS

Vector Frame™ Monitor Kiosks are a sleek, stylish way to display media at any tradeshow, event, in a retail or corporate space. The kiosks feature push-fit fabric graphics, easy-to-assemble 4" extrusion frames, your choice of single or double sided graphics and one or two monitor mounts (monitors not included). These kiosks complement the Vector Frame line of banners, backwalls, exhibit kits and counters.



front with graphic & monitor mount*

01 Monitor Kiosk
VF-MK-01-SS
VF-MK-01-DS
36.3" w x 94.74" h x 19.69" d
comes in 1 OCH case
supports 26-40" monitor*;
max weight = 25 lbs each



back with graphic



back with graphic & monitor mount*



top view
one monitor mount



front with graphic & monitor mount*

02 Monitor Kiosk
VF-MK-02-SS
VF-MK-02-DS
48.11" w x 94.74" h x 19.69" d
comes in 1 OCH case
supports 26-40" monitor*;
max weight = 25 lbs each



back with graphic



back with graphic & monitor mount*



top view
two monitor mounts

*Monitors not included.

VECTOR FRAME **EDGE POSTER FRAMES**

Vector Frame™ Edge fabric poster displays combine durable, slim 3/4" lightweight aluminum extrusion frames and easy-to-apply push-fit fabric graphics. Custom frame sizes are available.



Square Sizes:

- VFE-S-01: 11.8" w x 11.8" h
- VFE-S-02: 23.62" w x 23.62" h
- VFE-S-03: 35.43" w x 35.43" h
- VFE-S-04: 47.24" w x 47.24" h
- VFE-S-05: 59.06" w x 59.06" h

Rectangle Sizes:

- VFE-R-01: 11.8" w x 23.62" h
- VFE-R-02: 11.8" w x 35.43" h
- VFE-R-03: 23.62" w x 35.43" h
- VFE-R-04: 23.62" w x 47.24" h



Features Include:

- slim, lightweight 3/4" aluminum frame
- easy-to-apply push-fit fabric graphic
- direct to wall mounting
- custom frame sizes available



use as posters in a retail setting

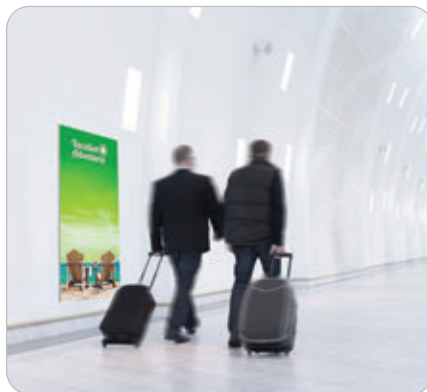

use as directional signs



use as advertisements



All Vector Frame displays are made in the USA and have a limited lifetime hardware warranty.

vector frame™ | 10' ESSENTIAL EXHIBIT KITS

VECTOR FRAME 10' ESSENTIAL EXHIBIT KITS

Stand apart from the competition with a clean, sophisticated 10' x 10' or 10' x 20' Vector Frame™ exhibit kit. These graphic mural kits feature square-corner 2" extrusion frames and push-fit fabric graphics that cover the entire frame. Vector Frame Essential kits are easy to assemble and disassemble.



easy to apply push-fit fabric graphics

*Counters in foreground included in purchased kits.



All Vector Frame displays are made in the USA and have a limited lifetime hardware warranty.

KIT 05
VF-K-05

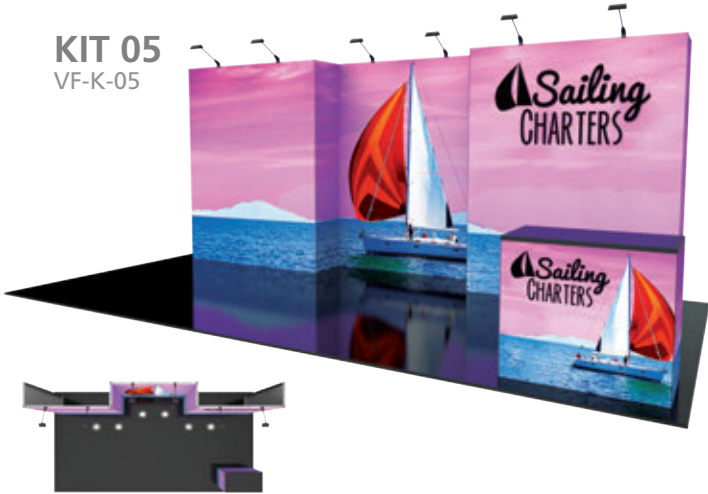

KIT 06
VF-K-06



KIT 07
VF-K-07



KIT 08
VF-K-08



Vector Frame counter tops are available in your choice of four thermoform finishes



OCH2 & OCE wheeled molded cases included with each kit (page 232-233)

*Counters in foreground included in purchased kits.

vector frame™ | 10' MASTER EXHIBIT KITS

VECTOR FRAME 10' MASTER EXHIBIT KITS

The innovative, contemporary and clean appearance of the Vector Frame™ Master line of exhibit kits will captivate your audience. Kits feature push-fit fabric graphics, easy-to-assemble extrusion frames, accent lighting, tables, counters, literature accessories, monitor mounts and interior LED edge lighting where indicated. Customized kits are also available.



KIT 09
VF-K-09



KIT 10
VF-K-10



KIT 11
VF-K-11



KIT 12
VF-K-12



easy to apply push-fit fabric graphics

*Counters in foreground included in purchased kits.



All Vector Frame displays are made in the USA and have a limited lifetime hardware warranty.

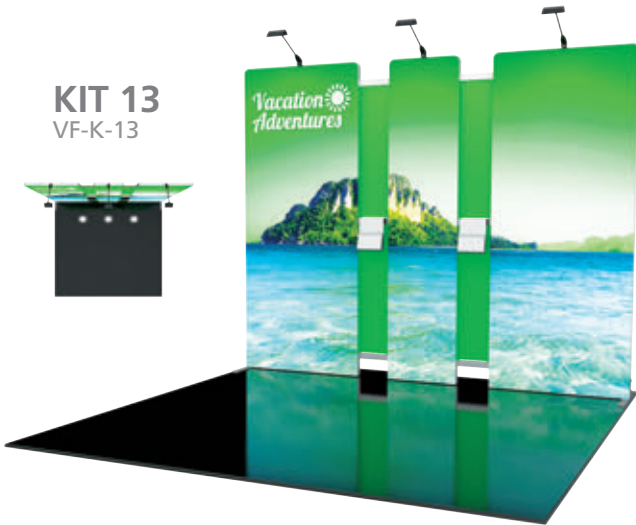

Vector Frame counter tops are available in your choice of four thermoform finishes



OCH2 & OCE wheeled molded cases included with each kit (page 232-233)

*Counters in foreground included in purchased kits.

vector frame™ | 20' MASTER EXHIBIT KITS

VECTOR FRAME 20' MASTER EXHIBIT KITS

The innovative, contemporary and clean appearance of the Vector Frame™ line of exhibit kits will captivate your audience. Kits feature push-fit fabric graphics, easy-to-assemble extrusion frames, accent lighting, tables, counters, literature accessories, monitor mounts and interior LED edge lighting where indicated.



KIT 17
VF-K-17

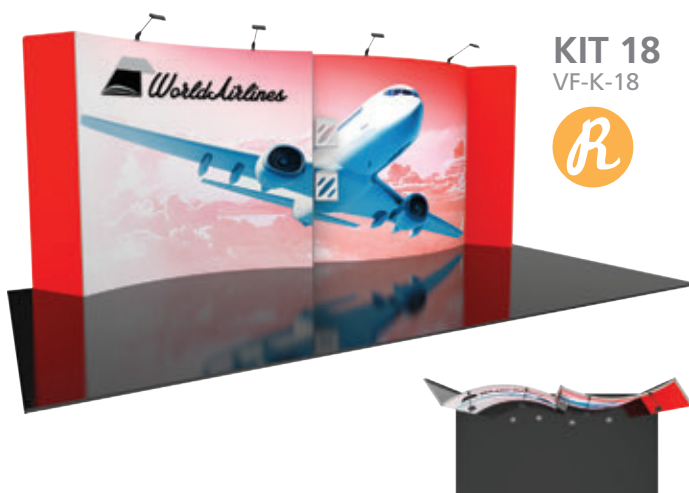

KIT 18
VF-K-18

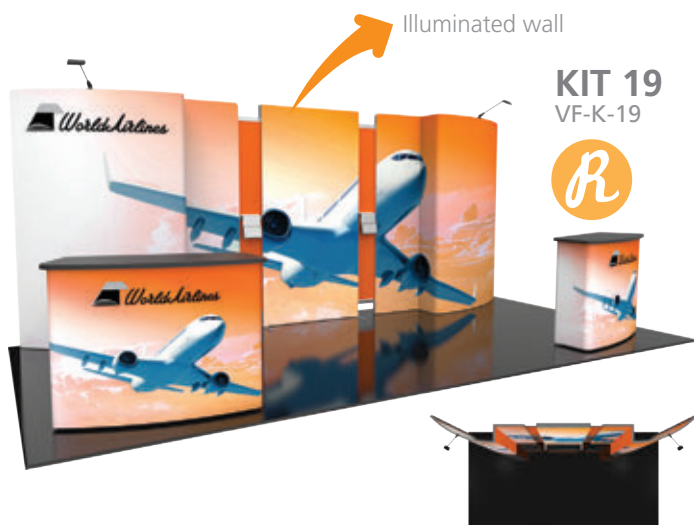

Illuminated wall

KIT 19
VF-K-19



KIT 20
VF-K-20



easy to apply push-fit fabric graphics

*Counters in foreground included in purchased kits.



All Vector Frame displays are made in the USA and have a limited lifetime hardware warranty.

KIT 21
VF-K-21

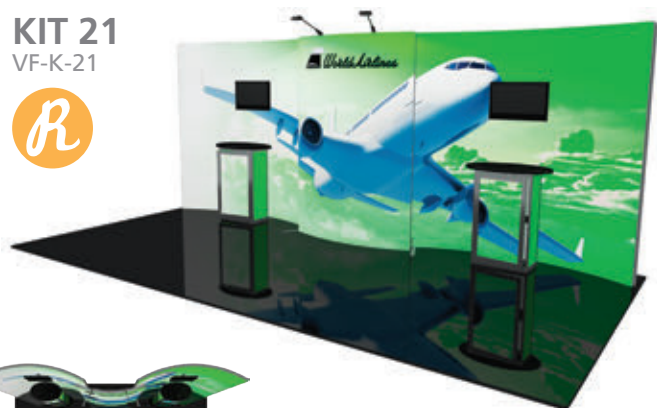

KIT 22
VF-K-22



KIT 23
VF-K-23



KIT 24
VF-K-24



Vector Frame counter tops are available in your choice of four thermoform finishes



silver black mahogany natural



OCH2 & OCE wheeled molded cases included with each kit (page 232-233)

Full line of counters shown on page 183.

*Counters in foreground included in purchased kits. Monitors not included.

VECTOR FRAME TABLETOPS

Vector Frame™ Tabletop Kits provide modern and dynamic flare to your marketing message. The silicone edge (SEG) push-fit fabric graphics and extrusion-based displays are simple, lightweight and take minutes to assemble. Units come in a sturdy case. Customized units also available.



5' tabletop
footprint dimensions:
55.5" w x 31.75" h x 11.81" d
VF-K-TT-01



5' tabletop
footprint dimensions:
61.3" w x 31.77" h x 11.81" d
VF-K-TT-02



4 1/2' tabletop
footprint dimensions:
56.14" w x 39.6" h x 17.09" d
VF-K-TT-03



8' tabletop
footprint dimensions:
95.7" w x 41.6" h x 11.81" d
VF-K-TT-04



easy to apply push-fit fabric graphics



OCS
wheeled molded
cases included
with each kit
(page 232)



All Vector Frame displays are made in the USA and have a limited lifetime hardware warranty.

Vector Frame counter tops are available in your choice of four thermoform finishes



VECTOR FRAME COUNTERS

Vector Frame™ counters complement the Vector Frame series of exhibit kits, but are also ideal for any stand-alone event or display. Vector Frame counters couple simple extrusion-based frames with push-fit fabric graphics or rigid sintra graphics. Tables are available in four colored finishes – silver, black, mahogany and natural. Counters fit in an OCH2 portable shipping case and allow for accessible storage by removing one fabric panel. Custom sizes also available.



Vector Frame Counter 01
39.37" w x 36.61" h x 22.44" d
VFC-01



Vector Frame Counter 02
55.5" w x 40.5" h x 22.5" d
VFC-02



Vector Frame Counter 03
38.5" w x 40.5" h x 19.88" d
VFC-03



Vector Frame Counter 04
30.63" w x 40.5" h x 18.75" d
VFC-04



Vector Frame Counter 05
39.76" w x 40.5" h x 22.75" d
- features locking door and rigid sintra graphics
VFC-05



Vector Frame Counter 06
41.63" w x 40.5" h x 20.75" d
- features locking door and rigid sintra graphics
VFC-06



Vector Frame Counter 07
46" w x 40.5" h x 22.64" d
VFC-07

LINEAR PRO 10' AND 20' DISPLAY SYSTEMS

Linear™ Pro modular display kits provide a modern, slick and stylish appearance. The extrusion based exhibits feature **Velcro-applied fabric graphics**. Headers and wings available in UV printed graphics or clear plex. Canopy is available in solid stock black, silver or white. Kits come with a fabric graphic canopy, two lights and ship in durable storage cases. Options include LCD monitor mounts, tables, counters, literature pockets and larger freight cases. Customized units also available.



LINEAR COUNTER LN-TBL-SA-RCT

- 3 graphic panels to display custom graphics
- quick & easy-to-assemble, tool included
- fits in an OCH shipping and transport case
- aluminum design is sturdy and stable
- optional locking door available
- available in all four laminate finishes



Linear counter tops are available in your choice of four thermoform finishes



silver black mahogany natural



All Linear exhibits, counters and kiosks are made in the USA, come with portable carry cases and a limited lifetime hardware warranty.

PRO 22
LN-K-3P-22



PRO 25
LN-K-3P-25



PRO 26
LN-K-3P-26



*Reconfigures to Kit 22

PRO 27
LN-K-3P-27



*Reconfigures to Kit 25

Linear accessories can be found on p. 231.
Top and side accents, lighting and tables included in kit.
*10' x 20' kits reconfigure to 10' x 10' sizes.

LINEAR PRO COUNTERS

Linear™ counters add function and flare to any space. Extrusion based construction coupled with your choice of rigid graphic infill panels or frosted plex panels make these kiosks sturdy and versatile. Counter tops are available in four thermoform finishes – silver, black, mahogany and natural. Printed graphic panels create the base of the counter. Counters come standard with locking cabinet door.



LN-CU-01



LN-CU-02



LN-CU-03



LN-CU-05



LN-CU-06



LN-CU-07



LN-CU-08

Linear counter tops are available in your choice of four thermoform finishes



silver black mahogany natural



All Linear exhibits, counters and kiosks are made in the USA, come with portable carry cases and a limited lifetime hardware warranty.



LINEAR COUNTER

LN-TBL-SA-RCT

- 3 graphic panels to display custom graphics
- quick & easy-to-assemble, tool included
- fits in an OCH shipping and transport case
- aluminum design is sturdy and stable
- open back; optional locking door available
- top available in four laminate finishes



LINEAR KIOSK 01

LN-K-01

- 54.4" w x 99" h x 23.25" d
- monitor* mount
- fabric canopy
- approximate weight: 125 lbs



LINEAR KIOSK 05

LN-K-05

- 25.38" w x 72.25" h x 18.5" d
- monitor* mount
- approximate weight: 30 lbs



Linear kiosks 01 and 05 come with an OCH case (page 233)



Linear kiosk counter tops are available in your choice of four thermoform finishes



silver black mahogany natural

*Monitor not included.





MERCHANDISE EXPRESS KIT 04
ME-K-04



MERCHANDISE EXPRESS **MODULAR**

The sharp, modern appearance of the Merchandise Express™ portable point-of-purchase display system will turn heads in any retail space, in-store environment or tradeshow space.

The Merchandise Express series is a collection of angular shaped displays that feature easy-to-assemble aluminum frames, push-fit fabric graphics, and shelves and pegboards designed to house and display lightweight merchandise. Kits come with interchangeable accessories - monitor mounts, shelving, pegboards and lighting where indicated.

The lightweight black aluminum frame pieces slide and quickly lock together. No tools are required for assembly, making Merchandise Express a durable, simple and effective selling tool. Display frames come with a one-year limited warranty. Push-fit fabric graphics are made in the USA—printed on state-of-the-art large format printing equipment and hand-finished by skilled professionals.

The versatile Merchandise Express kits can reconfigure into a variety of different sizes and can be further customized to create uniquely tailored display solutions.

COMBINE **MESSAGING** AND **MERCHANDISE** WITH AN IMPACT!



Merchandise Express Kit 04



Merchandise Express Kit 07



Merchandise Express Kit 02

MERCHANDISE EXPRESS POINT OF PURCHASE

Merchandise Express™ is a portable point of purchase display system that features simple black metal frames, shelving, pegboards and push-fit graphics to deliver products and messaging with an impact! Convenient rolling carry bags make transportation easy.



KIT 01
ME-K-01

- 9 ½'w full height straight backwall
- 3 Lumina 200 LED lights



KIT 02
ME-K-02

- 9 ½'w full height straight backwall
- 1 monitor* mount supports 50" monitor; max weight = 30 lbs
- 2 Lumina 200 LED lights

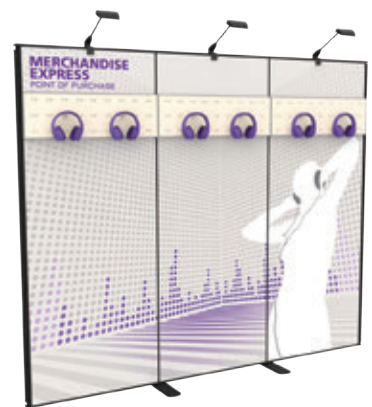

KIT 03
ME-K-03

- 9 ½'w full height straight backwall
- 3 pegboards; max weight per board = 10 lbs
- 3 Lumina 200 LED lights

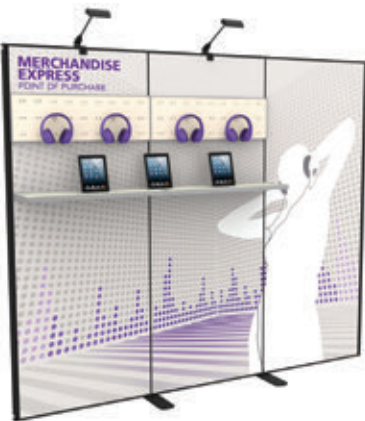

KIT 04
ME-K-04

- 9 ½'w full height straight backwall
- 2 pegboards; max weight per board = 10 lbs
- 2 adjustable height shelves; max weight per shelf = 10 lbs
- 2 Lumina 200 LED lights

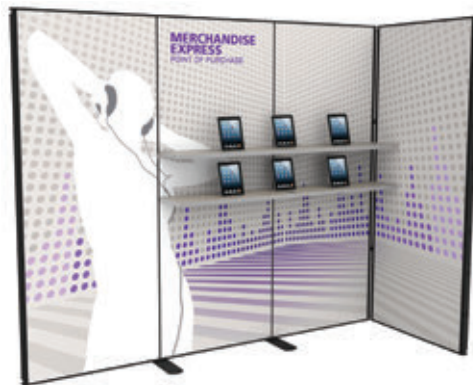

KIT 05
ME-K-05

- 9 ½'w full height straight backwall
- 1 side wall
- 4 adjustable height shelves; max weight per shelf = 10 lbs

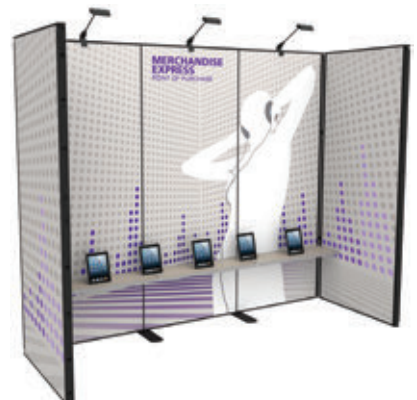

KIT 06
ME-K-06

- 9 ¾'w full height straight backwall
- 2 side walls
- 3 adjustable height shelves; max weight per shelf = 10 lbs
- 3 Lumina 200 LED lights

*Monitors, tablets and accessories not included.



MERCHANDISE EXPRESS
POINT OF PURCHASE



KIT 07
ME-K-07

- 19'w full height straight backwall
- 4 pegboards; max weight per board = 10 lbs
- 2 Lumina 200 LED lights



KIT 08
ME-K-08

- 19'w full height straight backwall
- 2 pegboards; max weight per board = 10 lbs
- 8 adjustable height shelves; max weight per shelf = 10 lbs
- 2 Lumina 200 LED lights



KIT 09
ME-K-09

- 19'w full height straight backwall
- 4 pegboards; max weight per board = 10 lbs
- 4 adjustable height shelves; max weight per shelf = 10 lbs
- 2 Lumina 200 LED lights



KIT 10
ME-K-10

- 19'w full height straight backwall
- 1 monitor* mount supports 50" monitor; max weight = 30 lbs
- 2 side walls
- 2 pegboards; max weight per board = 10 lbs
- 2 adjustable height shelves; max weight per shelf = 10 lbs

*Monitors and accessories not included.

orbital express™ truss | INTRODUCTION



LYNX
OR-K-LX1 



ORBITAL EXPRESS TRUSS

The bold, contemporary, industrial look of Orbital Express™ Truss exhibits dominates the show floor.

The Orbital Express Truss series is a collection of reconfigurable exhibit backwalls, islands and counters that feature a fixed number of parts and connectors. NO TOOLS are required for assembly; 20' x 20' and 10' x 20' inline kits transition into smaller size exhibits, counters and more.

The versatility and value of the Orbital Express Truss system is unmatched! Set-up and installation of Orbital Express Truss exhibits, backwalls and accessories is easy – simply twist & lock is all you have to do. All Orbital Express Truss display pieces are quality crafted and manufactured in the USA. All fabric and UV-panel graphics are produced in the USA, printed on state-of-the-art, G7 color certified printers, and are finished by hand.

With endless designs and options to choose from, you are certain to find a solution that fits your needs. You can also easily customize your own Orbital Express Truss exhibit and make it completely unique.

THE ORBITAL EXPRESS TRUSS SYSTEM IS
VERSATILE, RECONFIGURABLE & EASY!

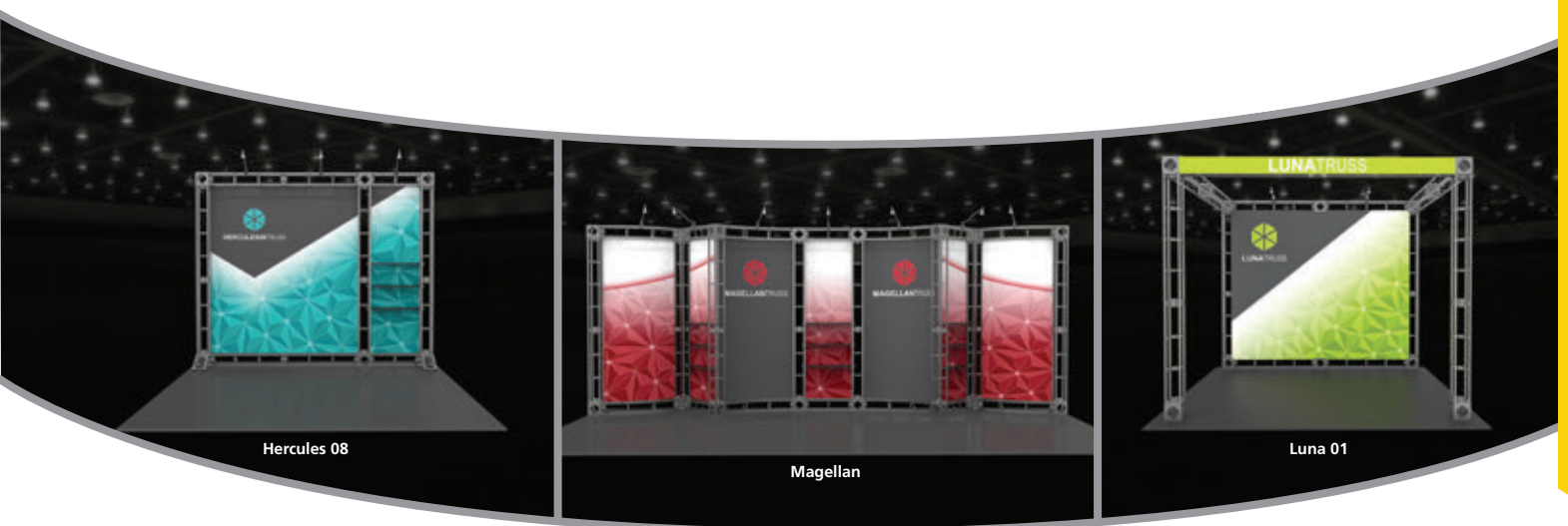

orbital express™ truss | 10' x 10' HERCULES KITS

10' HERCULES KITS

The Hercules line of Orbital Express™ Truss features basic backwalls and kits in a variety of sizes to suit a range of space needs. A benefit to this versatile system is that it enables you to reconfigure kits in multiple ways and combinations using the same parts. Simply add or subtract from any Hercules kit to create a new appearance for every event or tradeshow!

Truss counter tops are available in your choice of four thermoform finishes



HERCULES 02
OR-K-HC02



HERCULES 03
OR-K-HC03

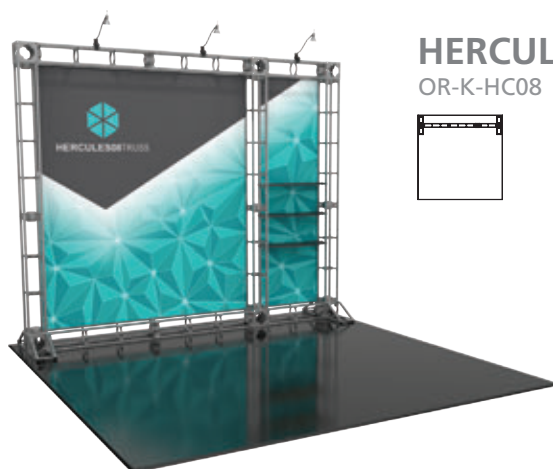

HERCULES 08
OR-K-HC08

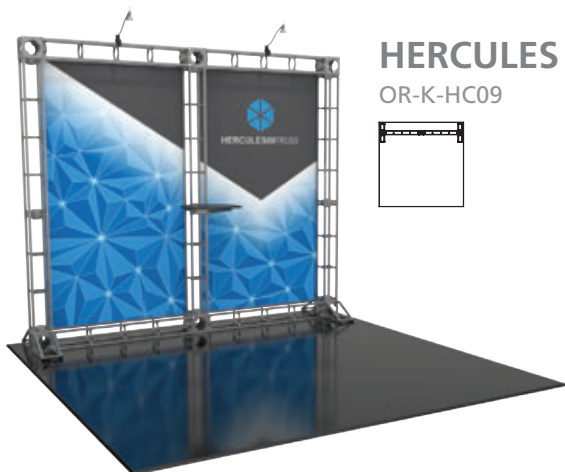

HERCULES 09
OR-K-HC09

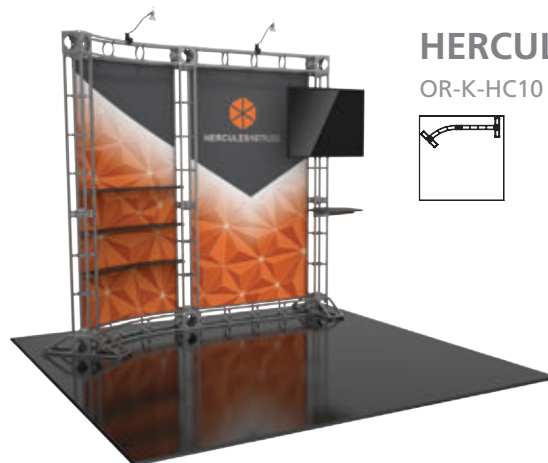

HERCULES 10
OR-K-HC10



HERCULES 12
OR-K-HC12

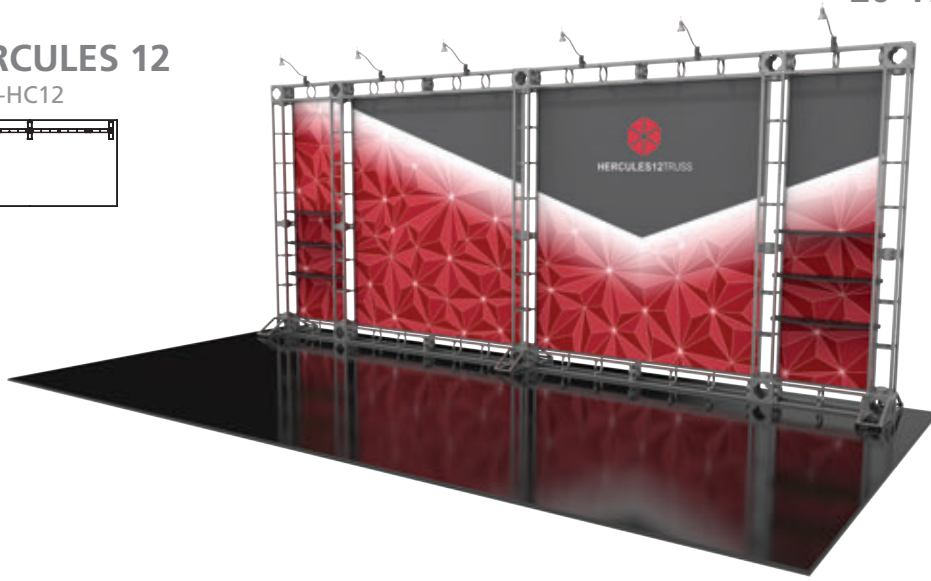
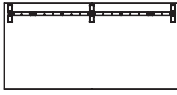

HERCULES 13
OR-K-HC13

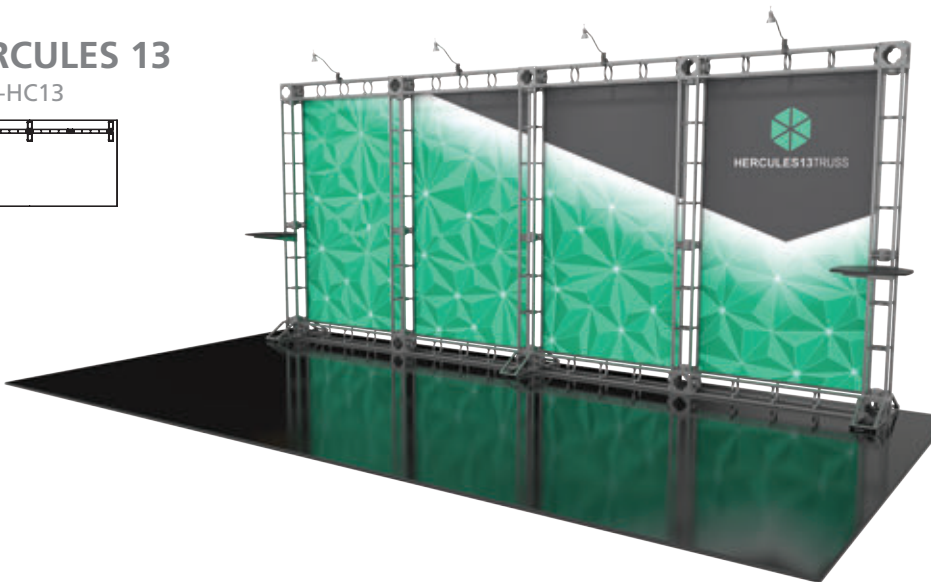

HERCULES 15
OR-K-HC15

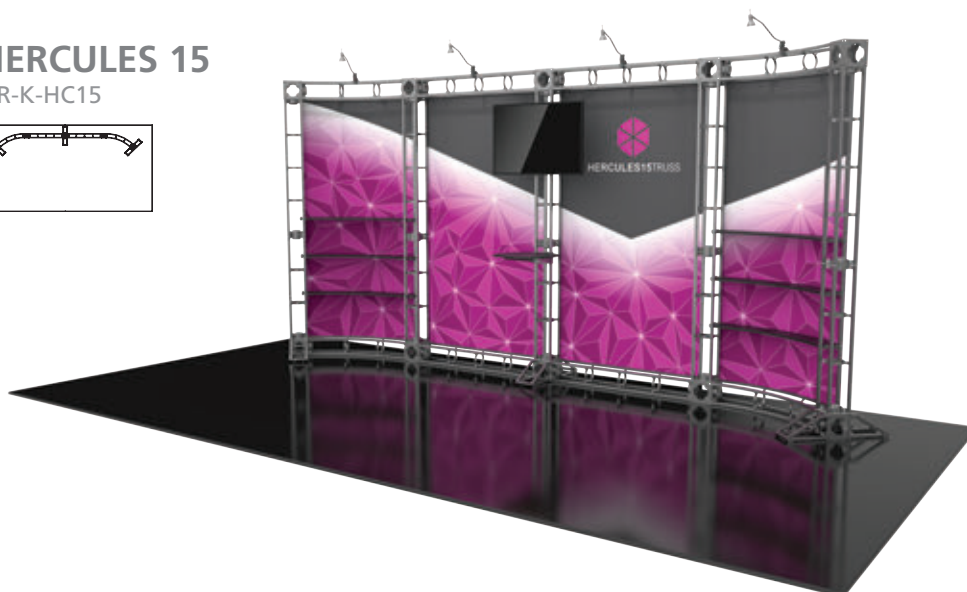

orbital express™ truss | 10' x 10' EXHIBIT KITS

10' EXHIBIT KITS

Orbital Express™ Truss features over 40 professionally designed “off the shelf” kits for a variety of booth sizes and configurations. Each kit comes complete with all the parts, fixtures and fittings you need to create a successful exhibit, including (depending on the kit) low voltage spotlights and adjustable tabletops. A benefit to this versatile system is that it enables you to reconfigure kits in multiple ways and combinations using the same parts. Orbital Express Truss can also be easily configured to fit your custom needs!



CLIO
OR-K-CO1

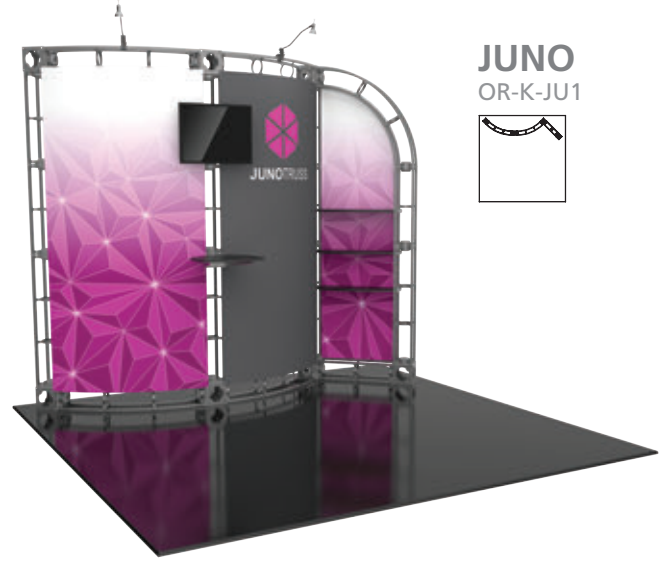

JUNO
OR-K-JU1

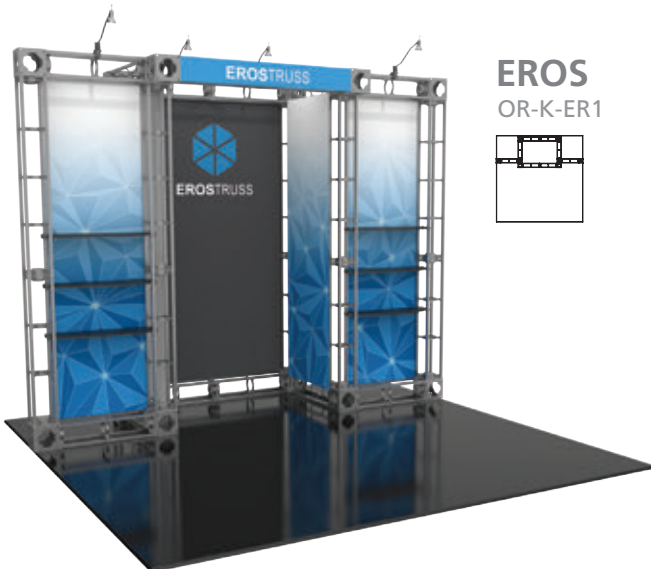

EROS
OR-K-ER1

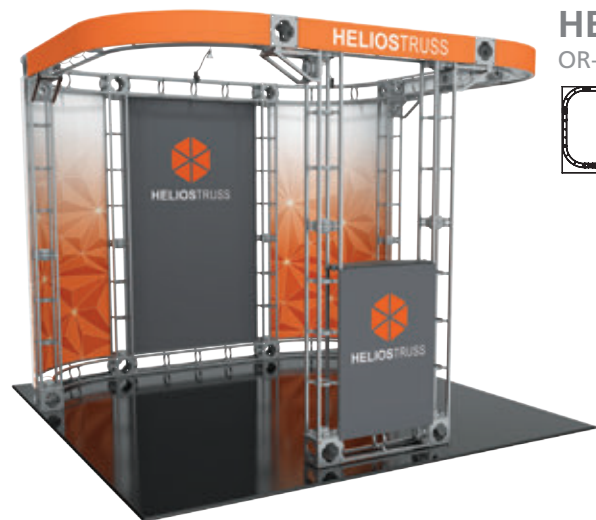

HELIOS
OR-K-HE1

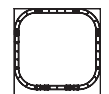

Truss counter tops are available in your choice of four thermoform finishes



silver black mahogany natural



10' EXHIBIT KITS

METIS
OR-K-MT1

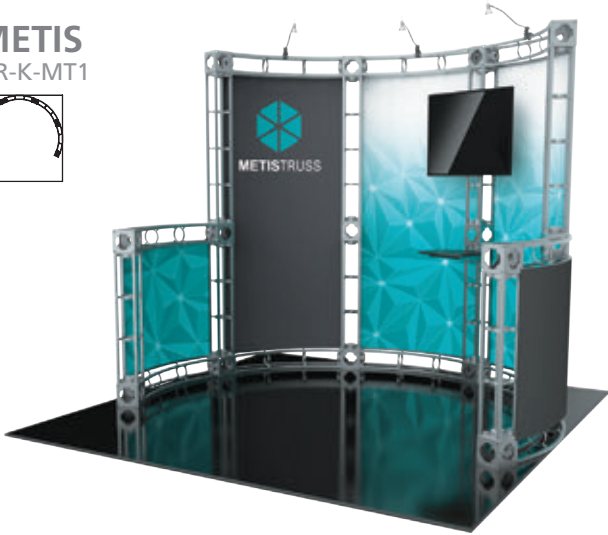

SIRIUS
OR-K-SR1



CASTOR
OR-K-CS1



LUNA 10
OR-K-LU1



LYRA
OR-K-LY2
corner kit



CYGNUS
OR-K-SYG2
corner kit



orbital express™ truss | 10' x 10' EXHIBIT KITS

10' EXHIBIT KITS

Orbital Express™ Truss features over 40 professionally designed “off the shelf” kits for a variety of booth sizes and configurations. Each kit comes complete with all the parts, fixtures and fittings you need to create a successful exhibit, including (depending on the kit) low voltage spotlights and adjustable tabletops. A benefit to this versatile system is that it enables you to reconfigure kits in multiple ways and combinations using the same parts. Orbital Express Truss can also be easily configured to fit your custom needs!



PLUTO

OR-K-PL1

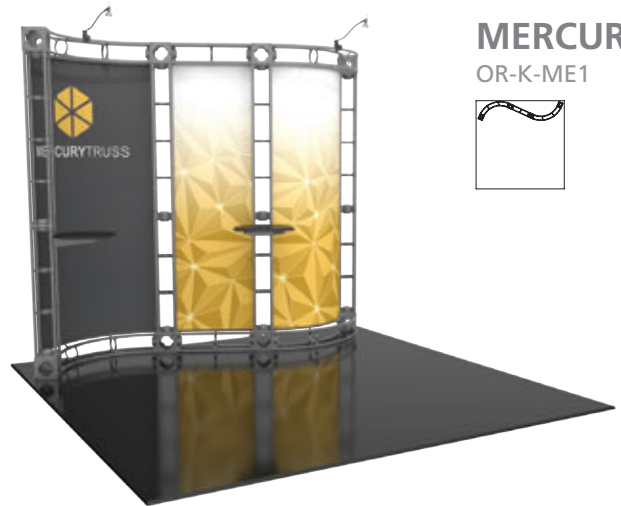

MERCURY

OR-K-ME1

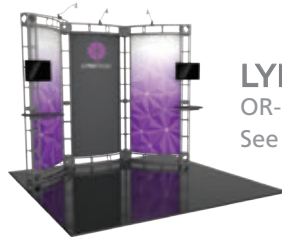
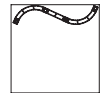

LYNX

OR-K-LX1

See page 192

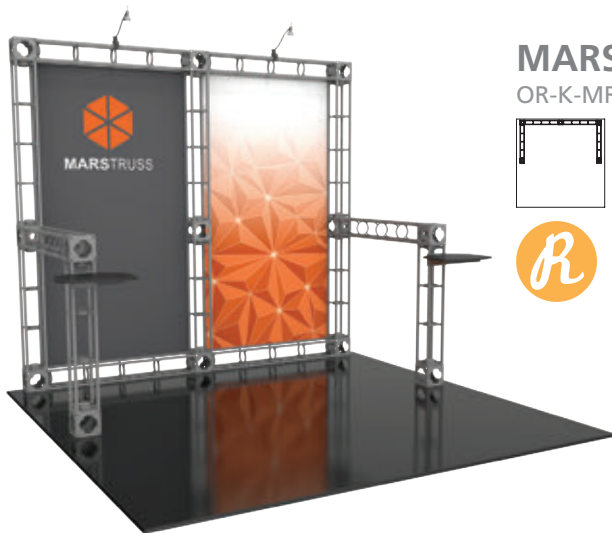

MARS

OR-K-MR1

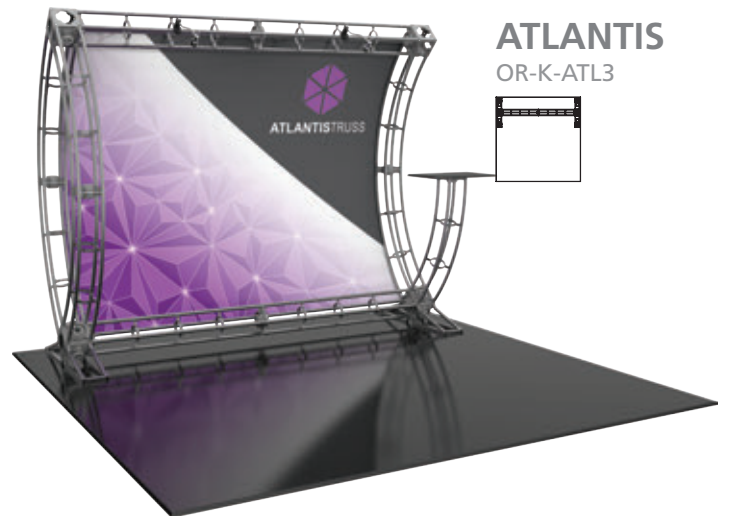

ATLANTIS

OR-K-ATL3

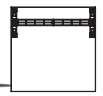

Truss counter tops are available in your choice of four thermoform finishes



silver black mahogany natural



RECONFIGURE INTO MULTIPLE SIZES



Easily convert the Corvus 20' x 20' Truss kit to a Polaris 10' x 20' style inline.

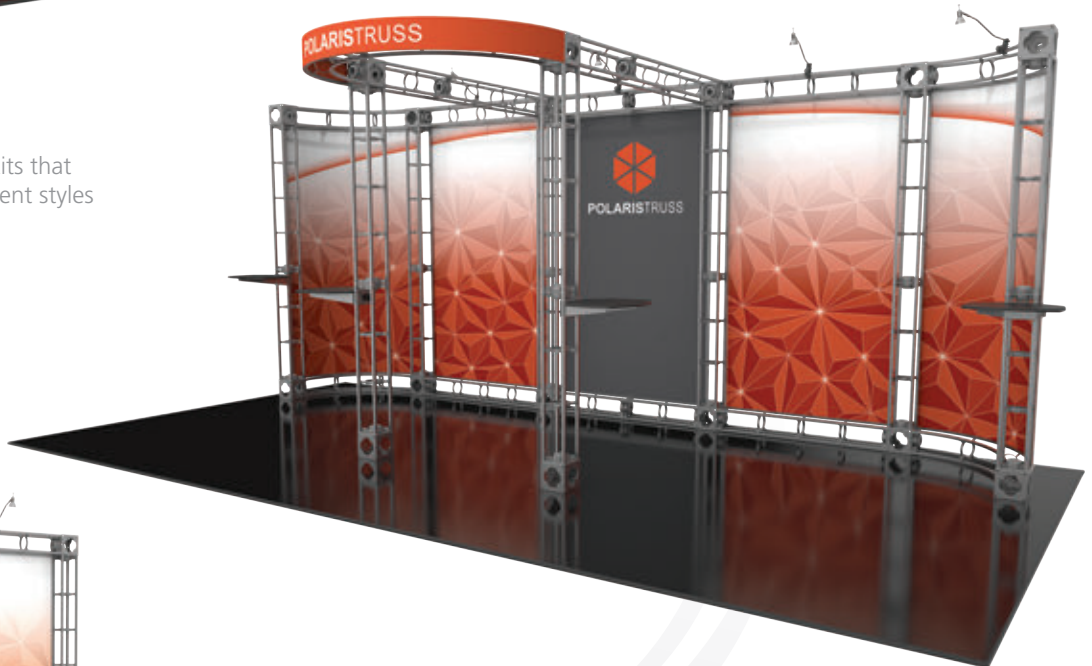

Ask about the many kits that reconfigure into different styles and sizes!

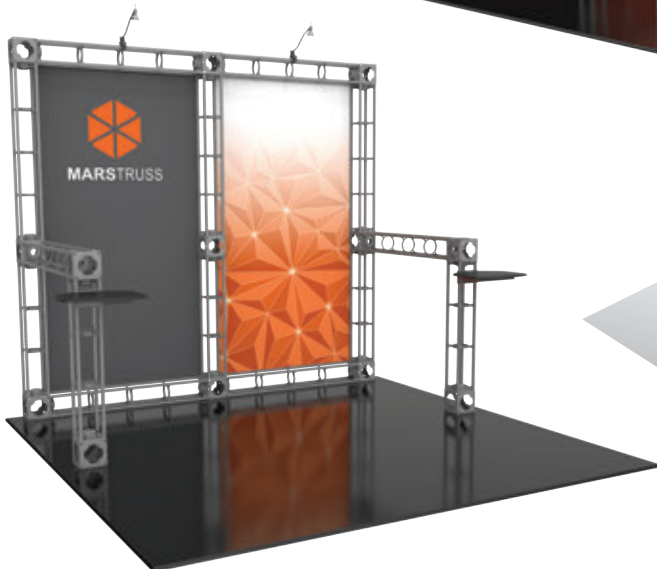

Then, convert the Polaris 10' x 20' kit into a Mars 10' x 10' kit configuration using existing parts.

orbital express™ truss | 10' x 20' EXHIBIT KITS

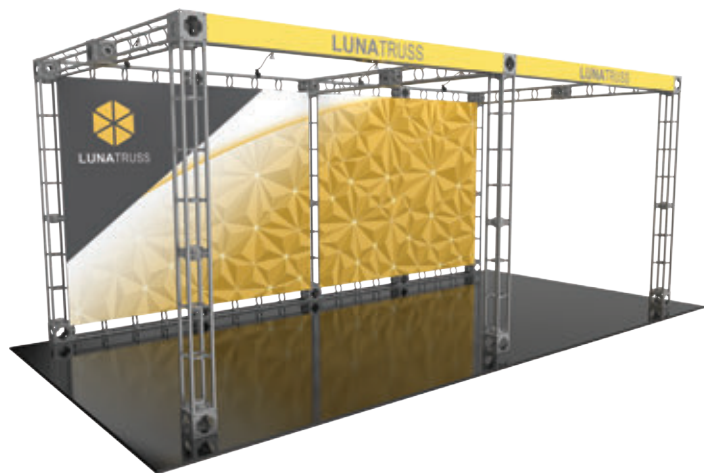

LUNA 20

OR-K-LU2

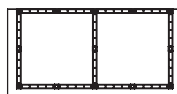

ORBEA

OR-K-OB1

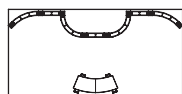

*includes counter

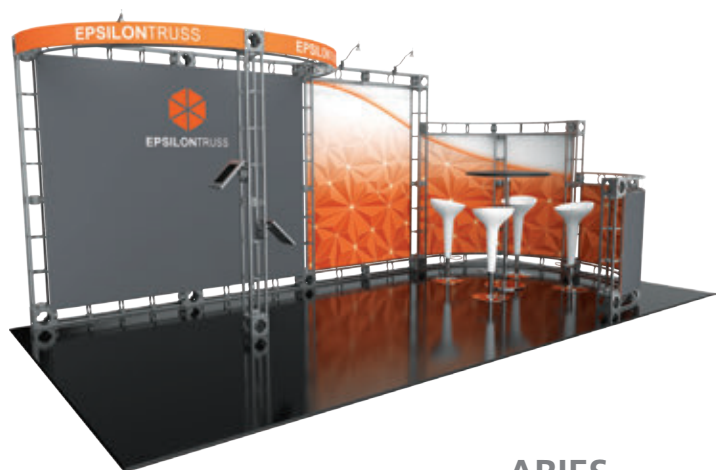
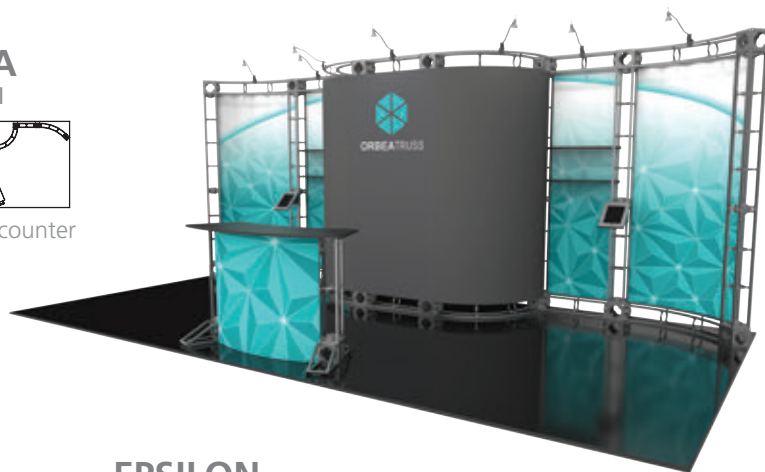

EPSILON

OR-K-EP1

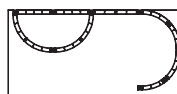

ARIES

OR-K-AI1

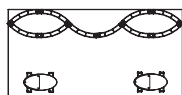

*includes counters

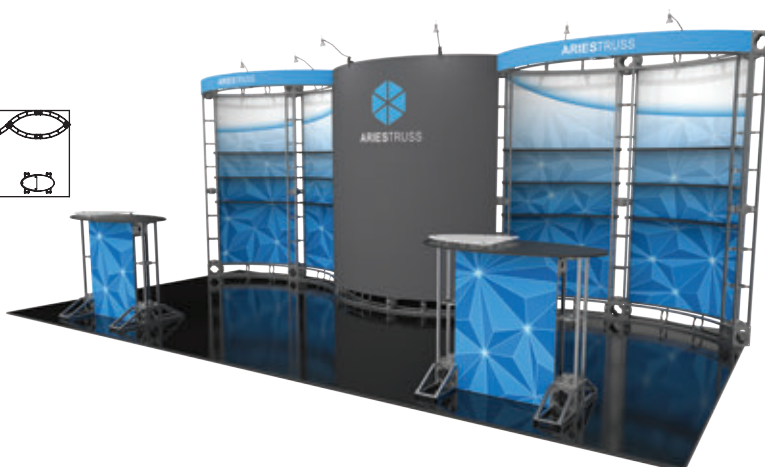

10' x 20' EXHIBIT KITS | orbital express™ truss

Truss counter tops are available in your choice of four thermoform finishes

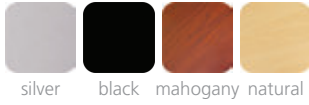

APEX OR-K-AX1

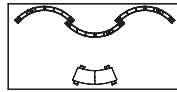

*includes counter and literature racks

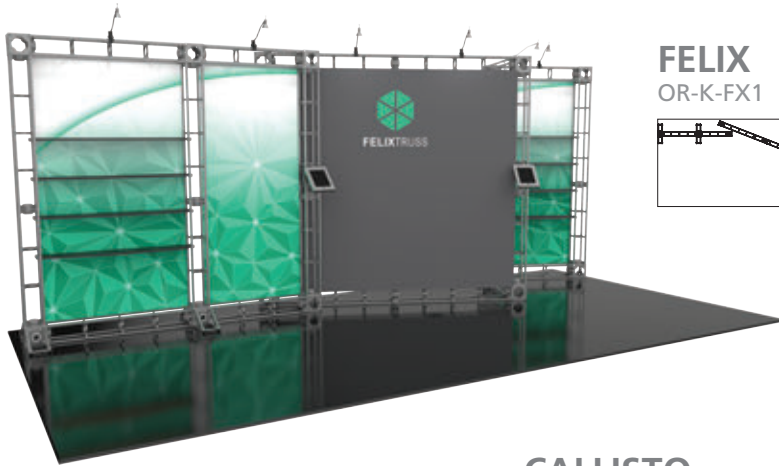
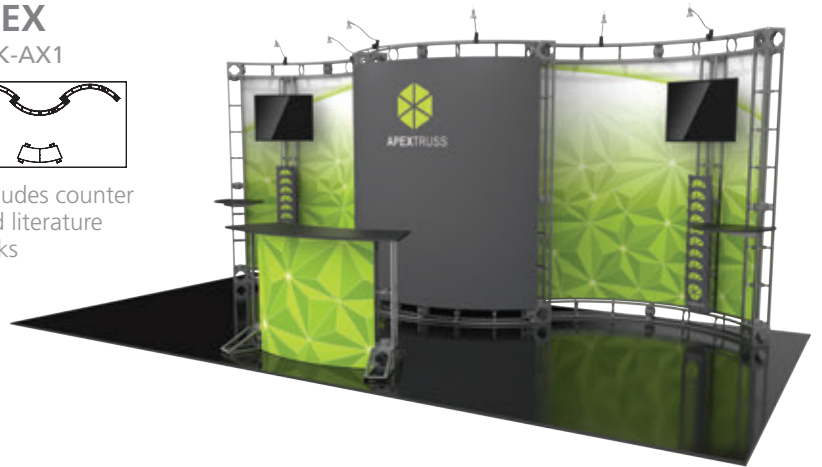

FELIX OR-K-FX1

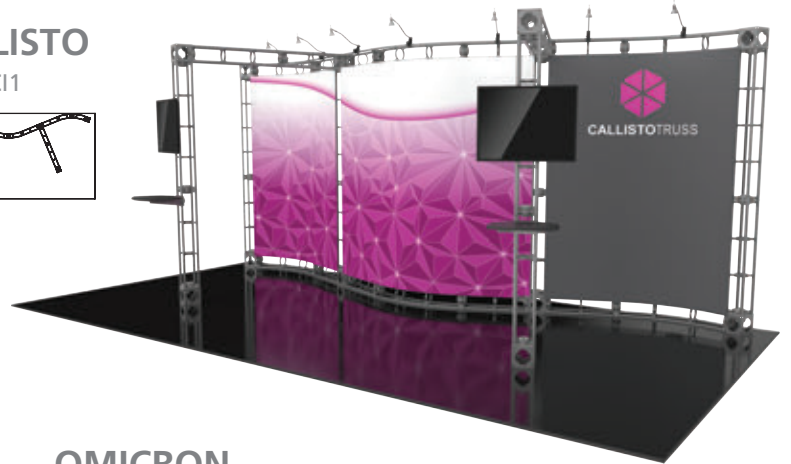
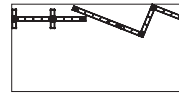

CALLISTO OR-K-CI1

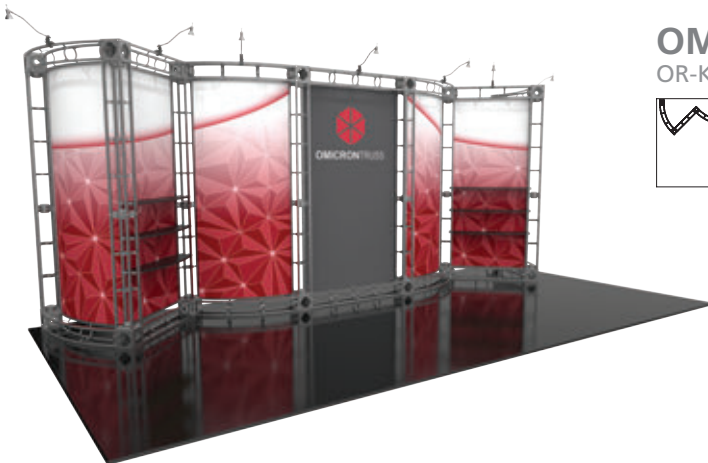
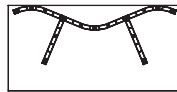

OMICRON OR-K-OM1

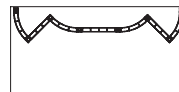

ORBITAL EXPRESS TRUSS | 10' X 20' EXHIBIT KITS



*Counters featured are included. Monitors, iPads and mounts, literature accessories and furniture are not included.

orbital express™ truss | 10' x 20' EXHIBIT KITS

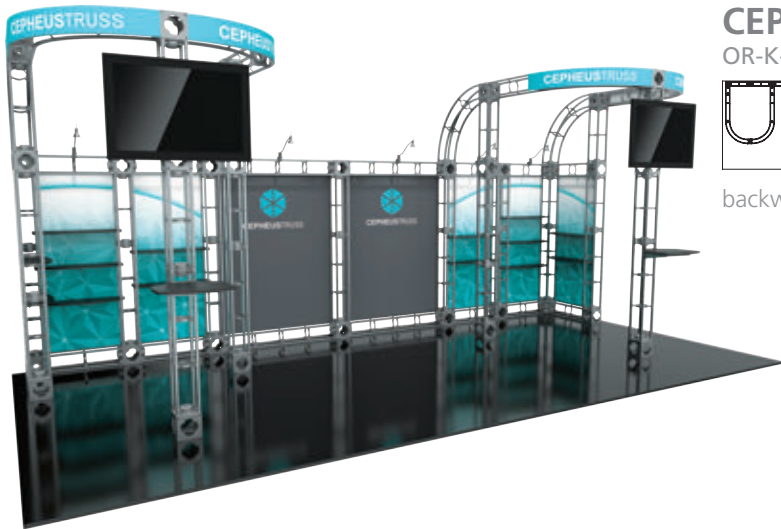

CEPHEUS-2

OR-K-CE1-2

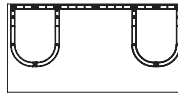

backwall height = 72.5"

SATURN

OR-K-SA1

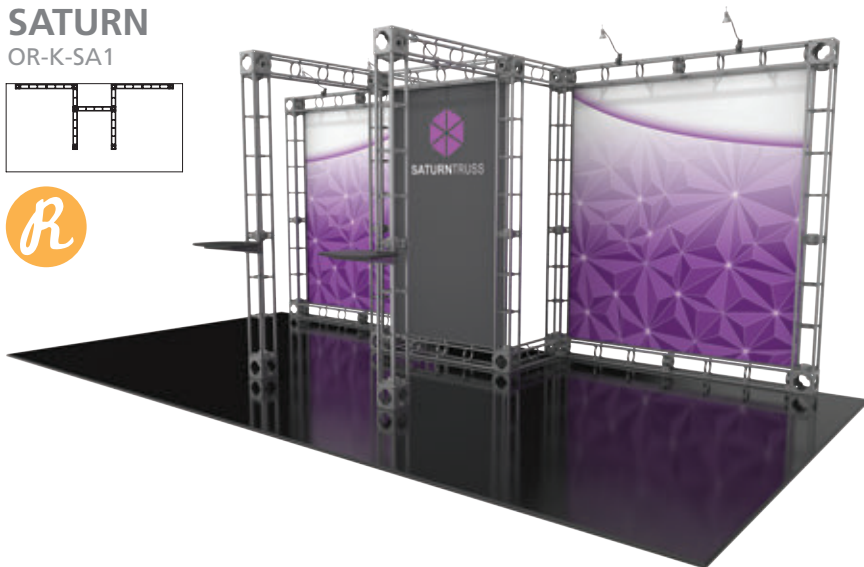
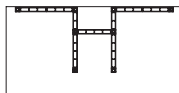

ANTARES

OR-K-AT1

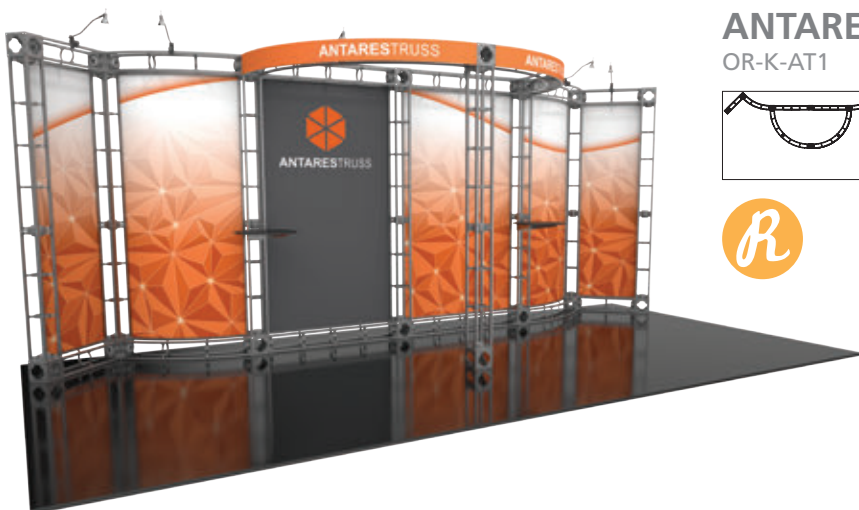
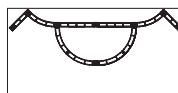

*Monitors not included.



10' x 20' EXHIBIT KITS | orbital express™ truss

Truss counter tops are available in your choice of four thermoform finishes



MAGELLAN OR-K-MG1

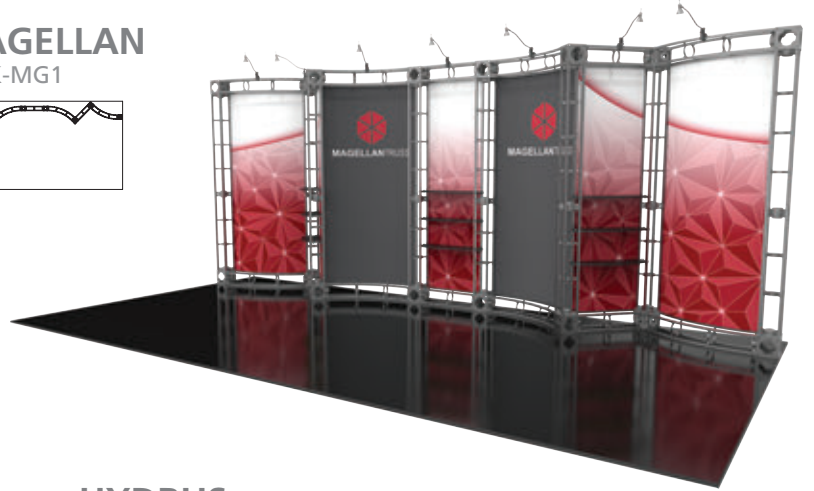
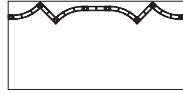

HYDRUS OR-K-HD1

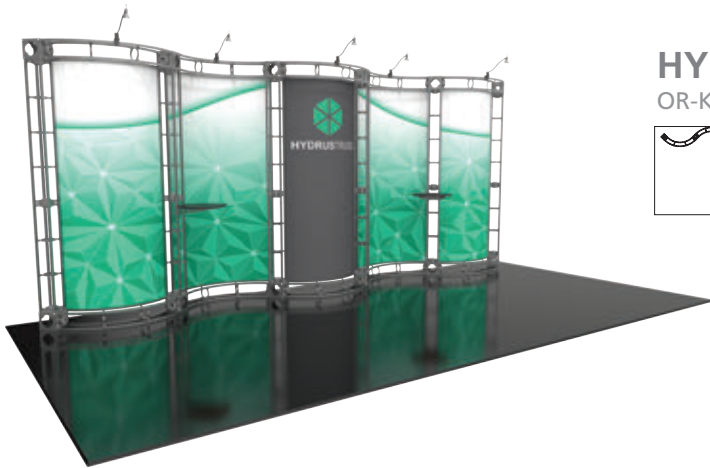
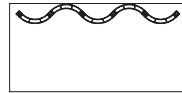

PHOENIX OR-K-PX1

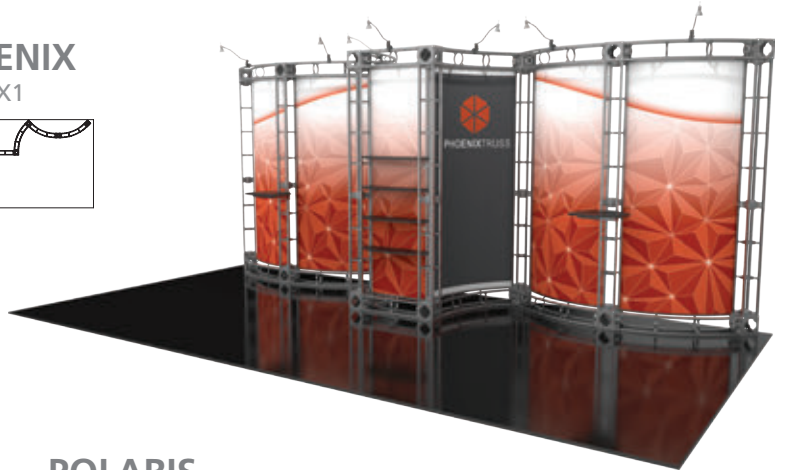
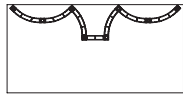

POLARIS OR-K-PR1

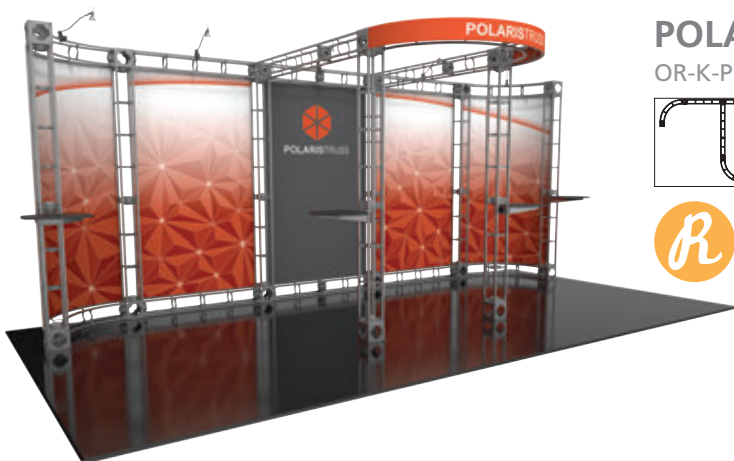
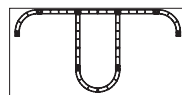

*Monitors not included.



ADAPTABLE, VERSATILE, MODULAR ORBITAL EXPRESS TRUSS



CORVUS
OR-K-CV1
20' x 20'

RECONFIGURES INTO THE FOLLOWING KITS:

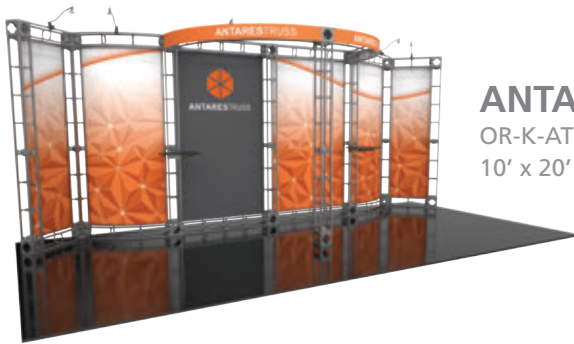

ANTARES
OR-K-AT1
10' x 20'

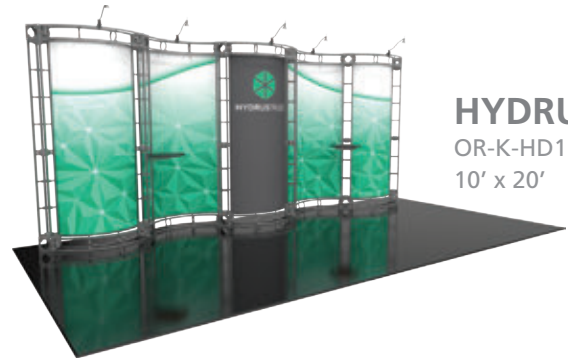

HYDRUS
OR-K-HD1
10' x 20'

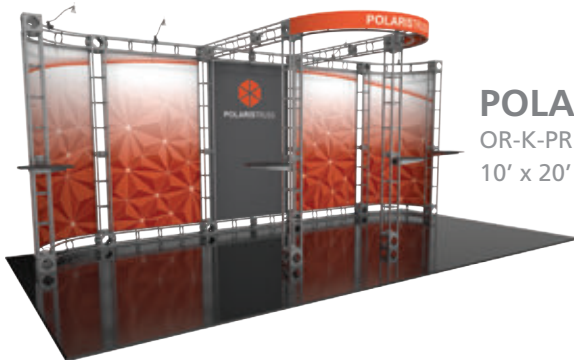

POLARIS
OR-K-PR1
10' x 20'

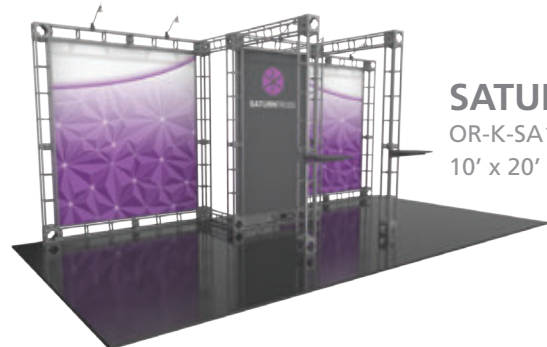

SATURN
OR-K-SA1
10' x 20'

RECONFIGURE INTO MULTIPLE SIZES



RECONFIGURES INTO THE FOLLOWING KITS:

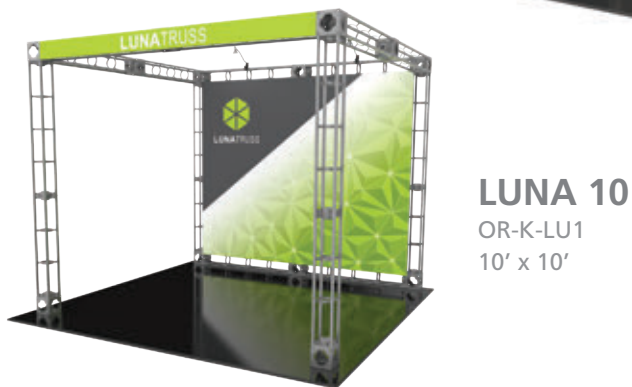
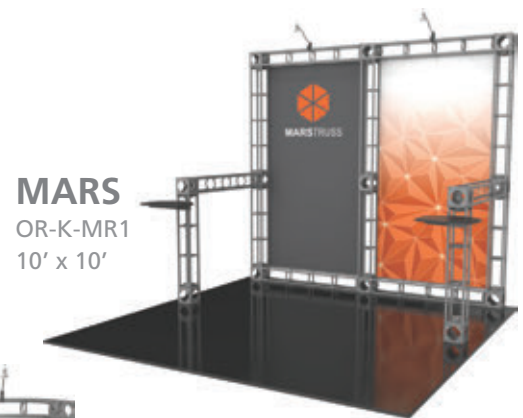
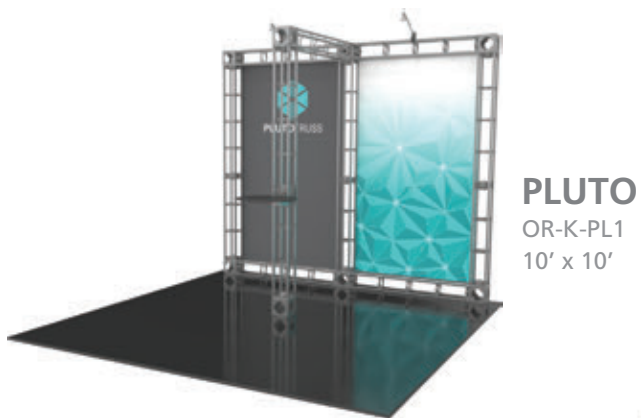

*Additional graphics may need to be purchased to reconfigure kits.

orbital express™ truss | 20' x 20' ISLAND KITS

20' ISLAND KITS

Orbital Express™ Truss features over 40 professionally designed “off the shelf” kits for a variety of booth sizes and configurations. Each kit comes complete with all the parts, fixtures and fittings you need to create a successful exhibit, including (depending on the kit) low voltage spotlights and adjustable tabletops. A benefit to this versatile system is that it enables you to reconfigure kits in multiple ways and combinations using the same parts. Orbital Express Truss can also be easily configured to fit your custom needs!

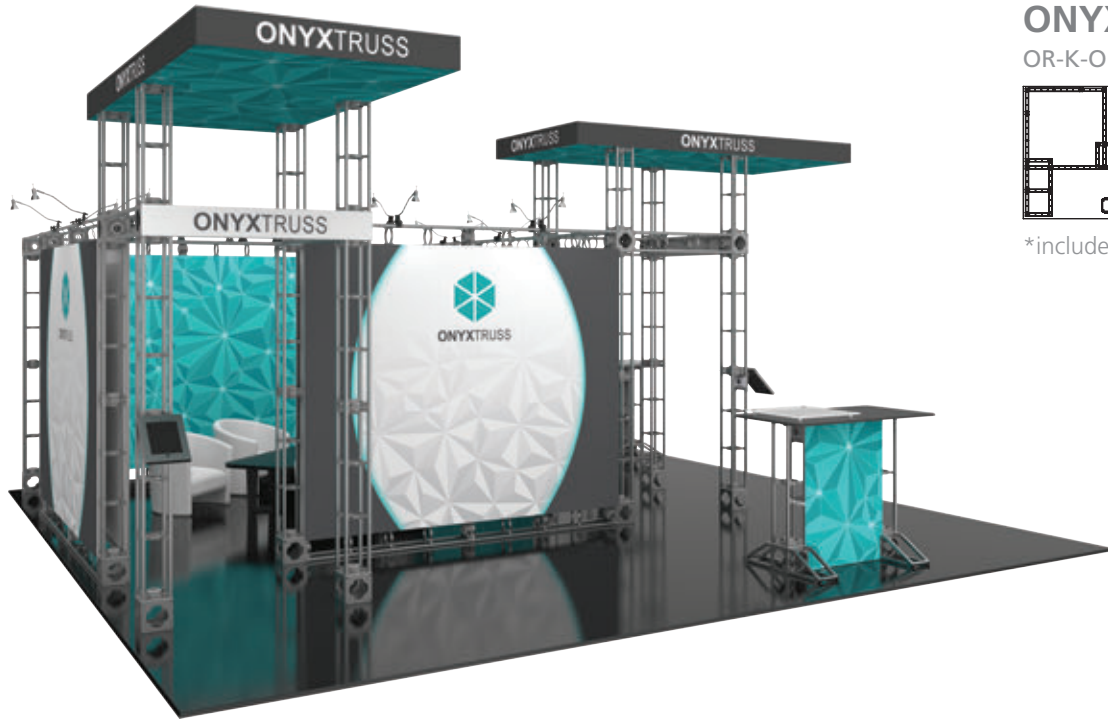

ONYX
OR-K-ON1

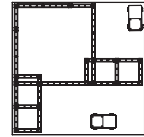

*includes counters



TUCANA
OR-K-TU1

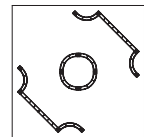

20' x 20' ISLAND KITS | orbital express™ truss

Truss counter tops are available in your choice of four thermoform finishes

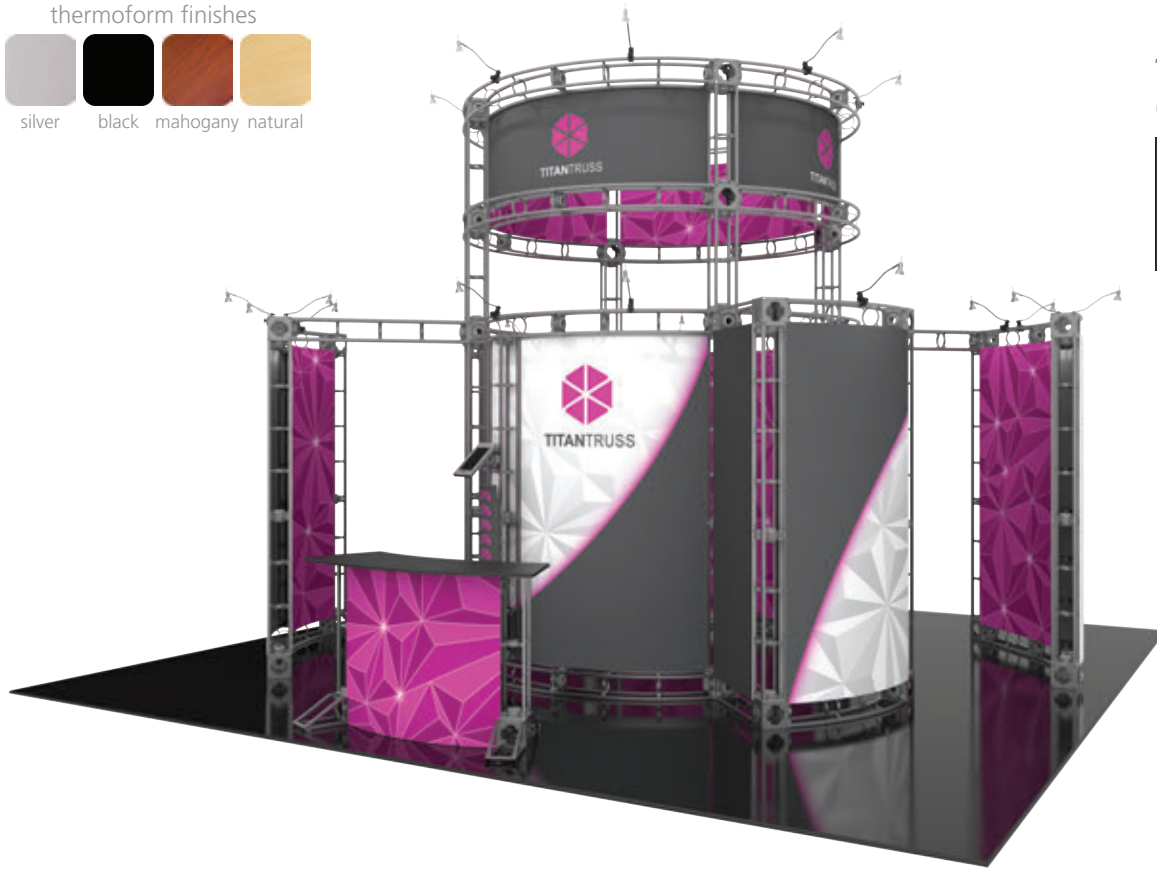
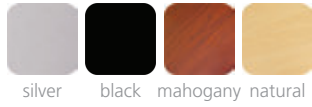

TITAN
OR-K-T11

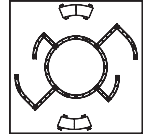

*includes counter

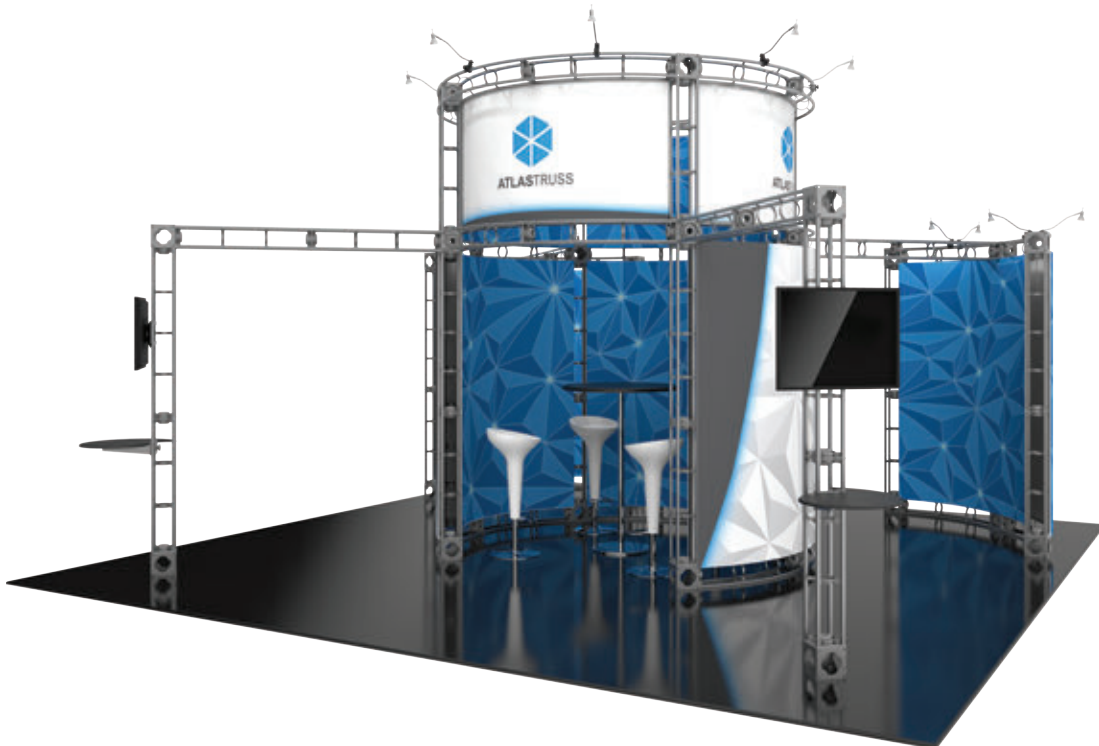

ATLAS
OR-K-AS1

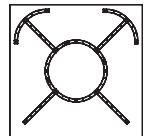

ORBITAL EXPRESS TRUSS | 20' X 20' ISLAND KITS



*Counters featured are included. Monitors, iPads and mounts, literature accessories and furniture are not included.

orbital express™ truss | 20' x 20' ISLAND KITS

CALYPSO OR-K-CL1

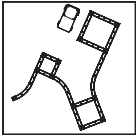

*includes counter

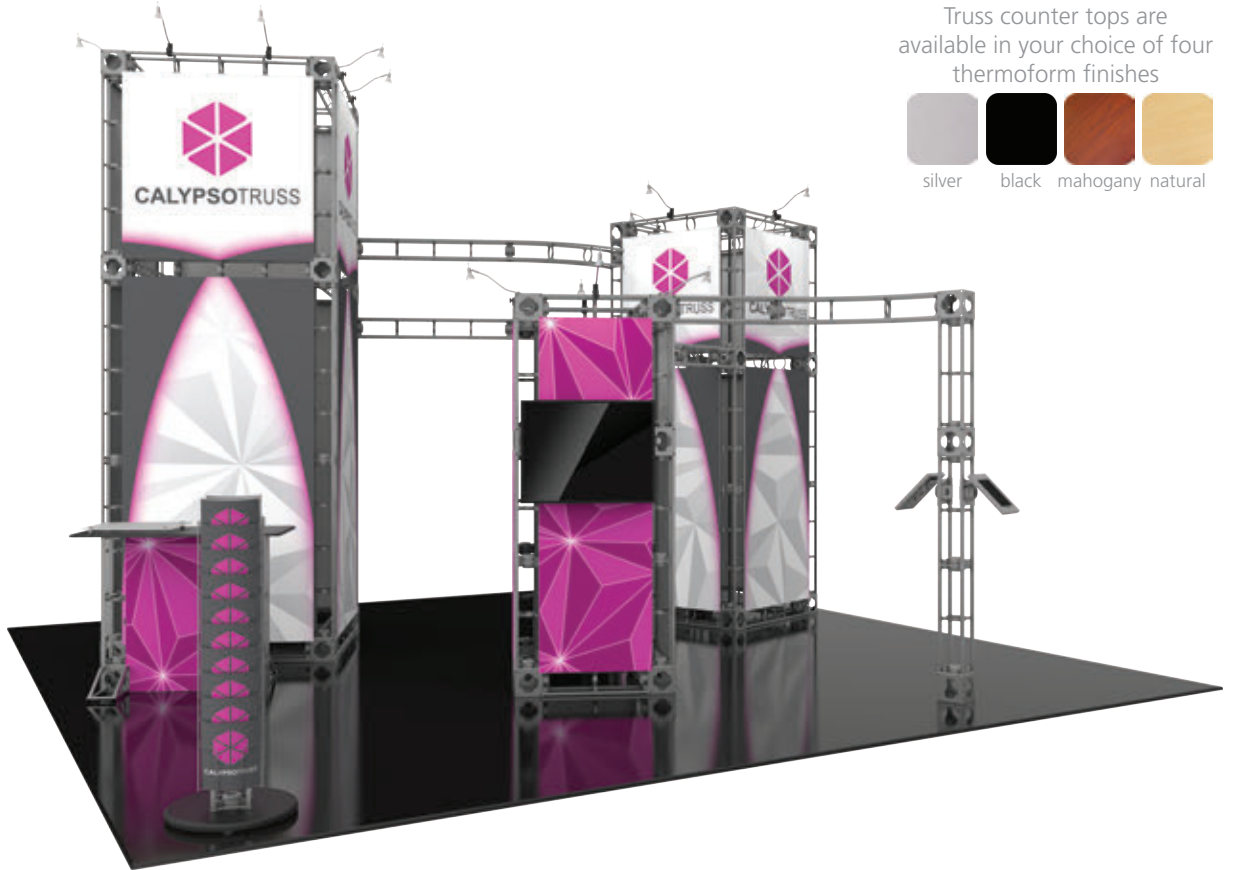

Truss counter tops are available in your choice of four thermoform finishes

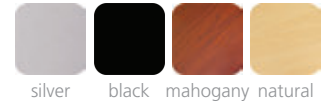

silver black mahogany natural

AARHUS OR-K-AH1

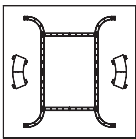

*includes counters

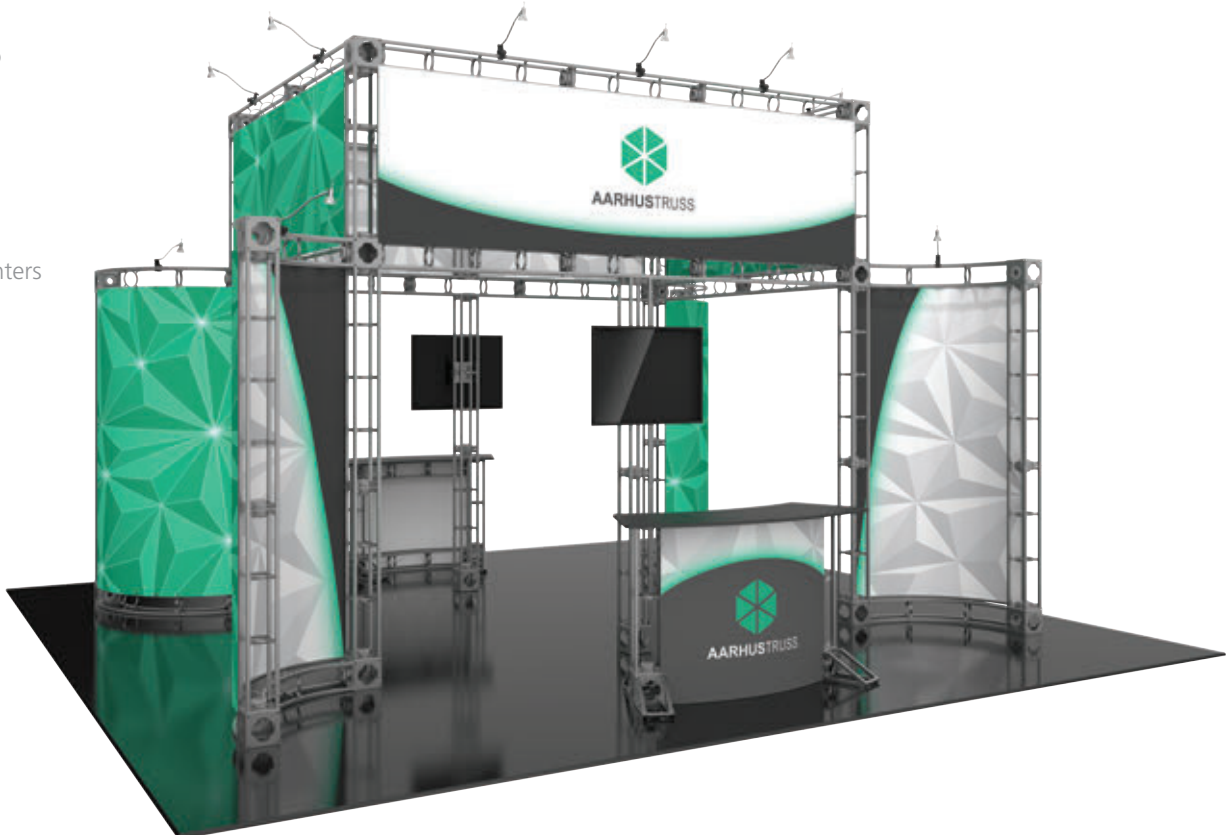

*Counters featured are included. Monitors, iPads and mounts, literature accessories and furniture are not included.

20' x 20' ISLAND KITS | **orbital express™ truss**



GEMINI
OR-K-GE1

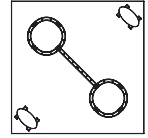

*includes counters

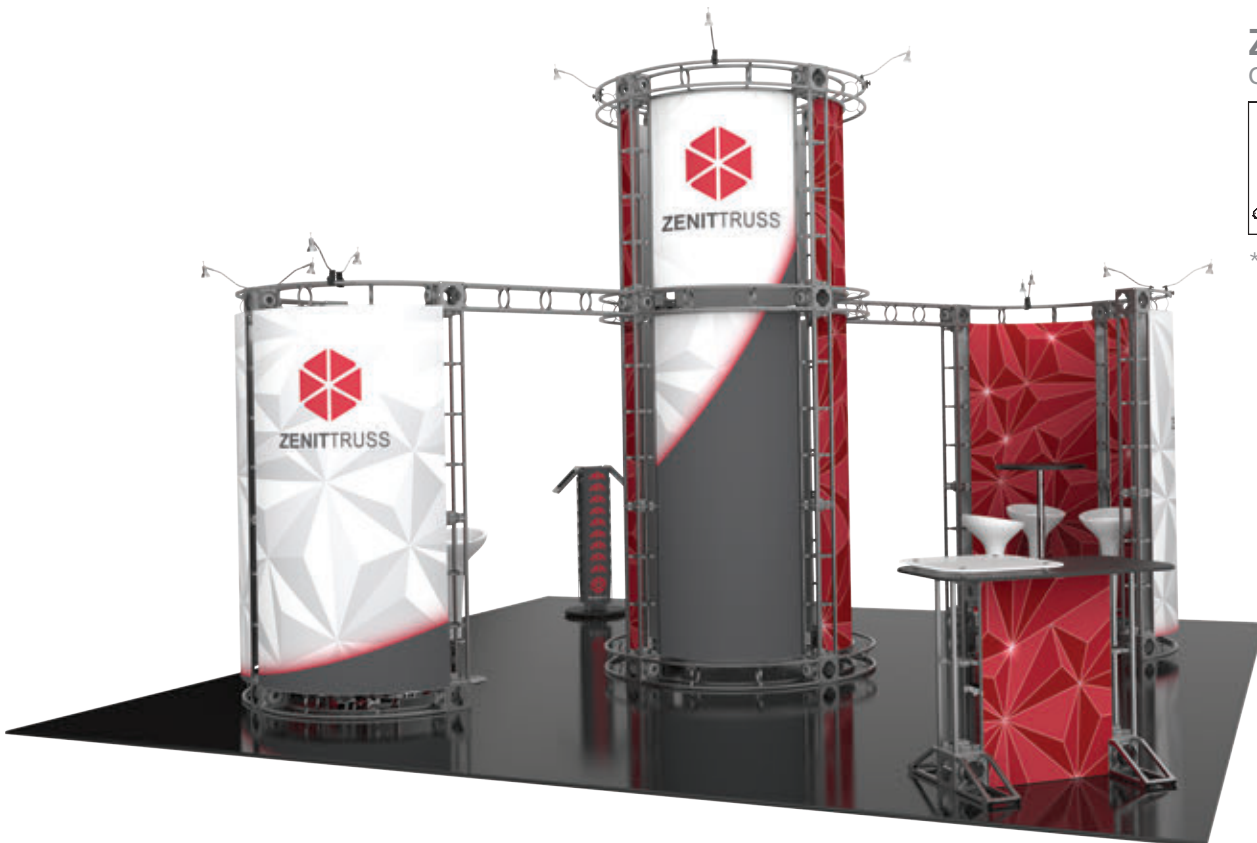

ZENIT
OR-K-ZE1

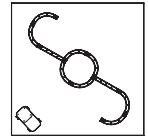

*includes counter

ORBITAL EXPRESS TRUSS | 20' X 20' ISLAND KITS



*Counters featured are included. Monitors, iPads and mounts, literature accessories and furniture are not included.

orbital express™ truss | 20' x 20' ISLAND KITS

OPTIMUS

OR-K-OP1

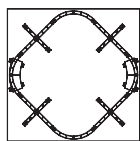

*includes counters and literature racks



Truss counter tops are available in your choice of four thermoform finishes



silver black mahogany natural

DORADO

OR-K-DO1

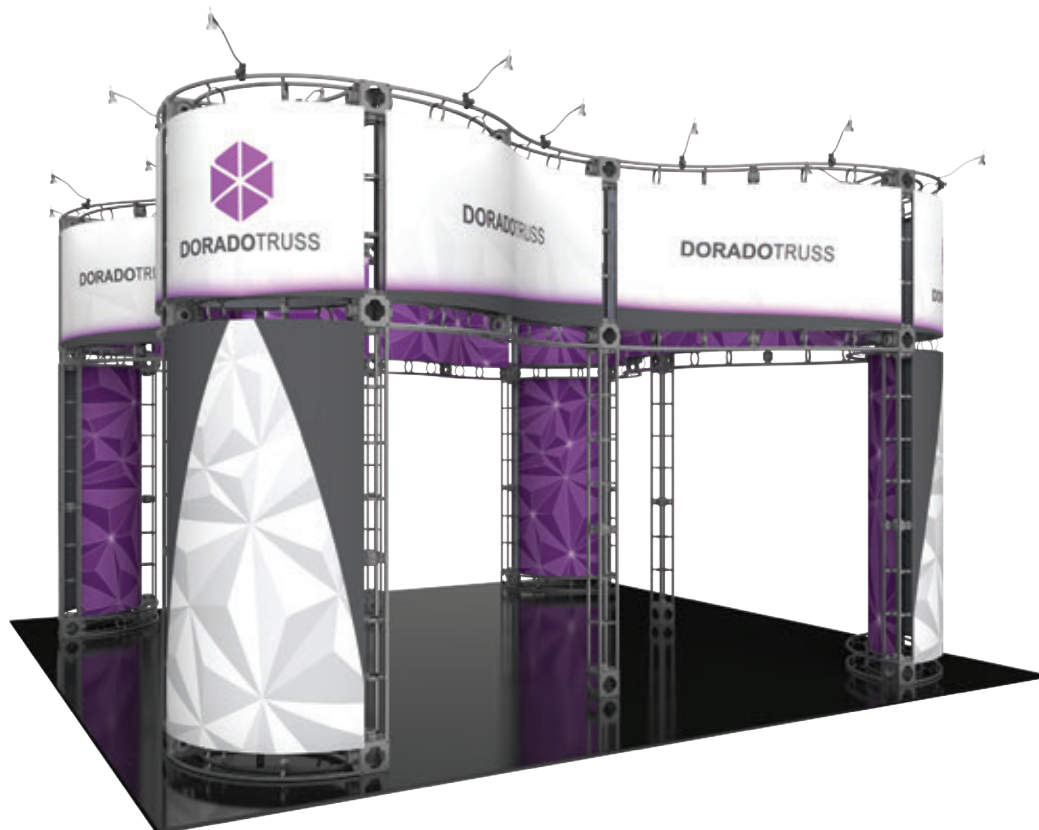
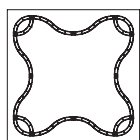

*Counters featured are included.

20' x 20' ISLAND KITS | orbital express™ truss



CORVUS
OR-K-CV1

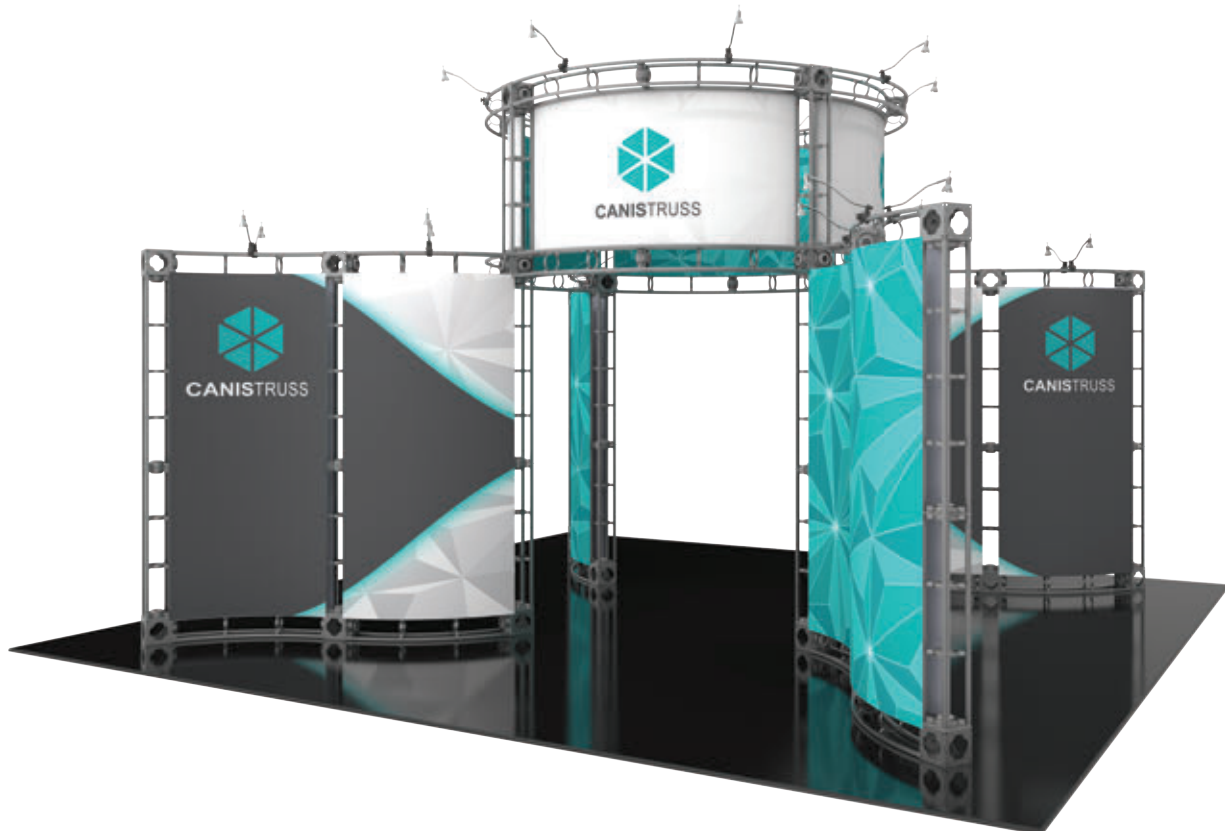
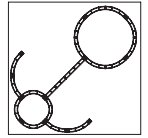

CANIS
OR-K-CA1

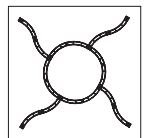

ORBITAL EXPRESS TRUSS | 20' X 20' ISLAND KITS



*Counters featured are included.

orbital express™ truss | 20' x 20' ISLAND KITS

VESTA OR-K-VS1

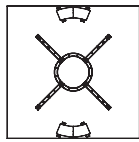

*includes counter

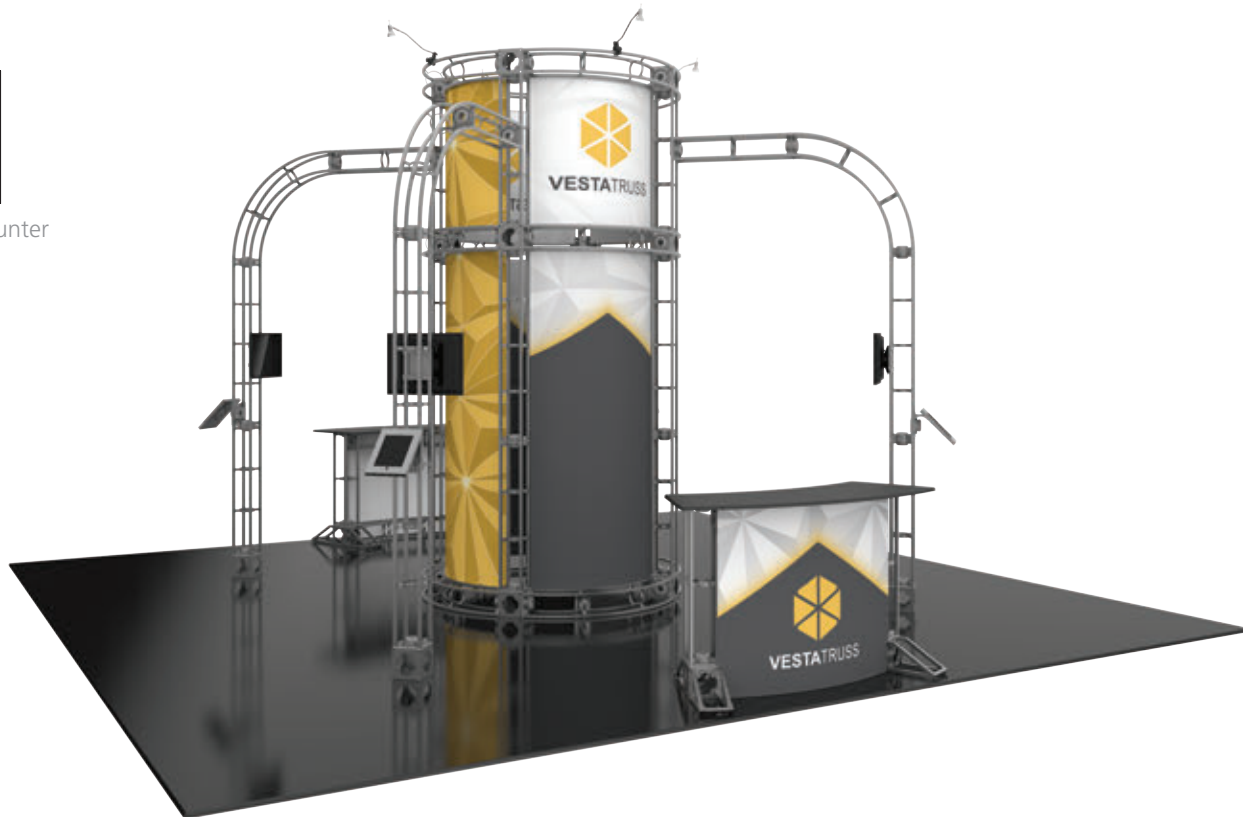

JANUS OR-K-JA1

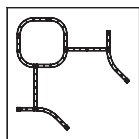

COUNTERS AND PODIUMS

Truss Counters and Podiums have several attractive designs to choose from with a sleek plex top as an available option. Choose from four tabletop colors. Graphic options are also available for Truss Counters. No tools needed for assembly.



RECTANGLE
 standard: OR-TC01
 with plex stand-off and
 internal shelf: OR-TC01-P



OVAL
 standard: OR-TC02
 with plex stand-off and
 internal shelf: OR-TC02-P



RACETRACK
 standard: OR-TC03
 with plex stand-off and
 internal shelf: OR-TC03-P



CURVE
 standard: OR-TC04
 with plex stand-off and
 internal shelf: OR-TC04-P



RACETRACK
 standard: OR-P04
 with plex stand-off: OR-P04-P



SQUARE
 standard: OR-P05
 with plex stand-off: OR-P05-P

Truss counter tops are available in your choice of four thermoform finishes



silver black mahogany natural



ACCESSORIES

Accessories such as tabletops, shelves, literature holders and monitor mounts add functionality and options to your display. Truss tabletops and shelves come in four tabletop colors. No tools needed for assembly.



WIRE RACK

NEW

OR-24-MP-M
OR-36-MP
OR-46-MP

- grid wall with hook brackets
- hook brackets sold separately
- supports approx. 8 lbs. per panel
- OR-24-MP-M mounts to verticals

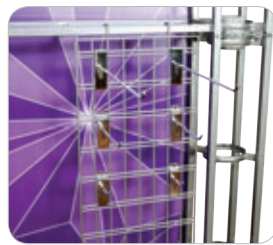

HANGING RACK

NEW

OR-36-SP
OR-46-SP

- slot wall with hook brackets
- hook brackets sold separately
- supports approx. 8 lbs. per panel



LAMINATE TABLETOPS

NATURAL



standard: OR-TBL-WD
right facing: OR-TBL2-R-WD
left facing: OR-TBL2-L-WD

MAHOGANY



standard: OR-TBL-DW
right facing: OR-TBL2-R-DW
left facing: OR-TBL2-L-DW

SILVER



standard: OR-TBL-S
right facing: OR-TBL2-R-S
left facing: OR-TBL2-L-S

BLACK



standard: OR-TBL-B
right facing: OR-TBL2-R-B
left facing: OR-TBL2-L-B

INTERNAL SHELVING

- available in choice of four finishes
- 24" straight span, 36" straight span, and 46" straight span shelves available
- 45° curved and 90° curved shelves

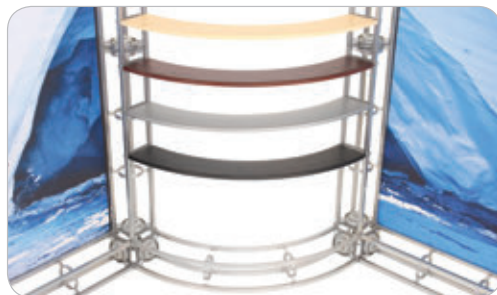

LIT RACK

R

OR-STG

- 10 pocket clamp on literature rack
- note: rack may not fit into the standard kit packaging solution/ molded case
- toolless attachment



Truss table tops and bases are available in your choice of four thermoform finishes



Orbital Express™ Truss Kiosks are the perfect way to display media and/or literature at any trade show, event, retail or corporate space. Kiosks complement the Orbital Truss Express line of 10', 20' and 20' by 20' displays. Monitors not included. Kiosk table tops and bases available in choice of four thermoform finishes.

ORBITAL KIOSK 01 OR-KIOSK-01

- 30" w x 73.75" h x 20" d
- supports 23" monitor*, max weight = 30 lbs
- rigid graphic = 12" w x 47.25" h x .25" d
- approximate weight = 39 lbs



ORBITAL KIOSK 02 OR-KIOSK-02

- 40" w x 73.75" h x 28.25" d
- supports 70" monitor*, max weight = 150 lbs
- adjustable shelf
- approximate weight = 89 lbs



ORBITAL KIOSK 06 OR-KIOSK-06

- 24" w x 56" h x 34" d
- supports 23" monitor*, max weight = 50 lbs
- table is 20" w x 14" d
- approximate weight = 44 lbs



TRUSS MONITOR MOUNTS



OPTI-MOUNT 1 OR-LCD1-B

13" - 39" LCD
max weight = 50 lbs



OPTI-MOUNT 2 OR-LCD2-B

40" - 50" LCD
max weight = 80 lbs



OPTI-MOUNT 3 OR-LCD3-B

32" - 70" LCD
max weight = 150 lbs

*Monitors and tablets not included.



AERO

The Aero portable modular display system is extremely versatile and configurable. Aero offers 11 graphic height options for each section of the display; simply modify by moving the top graphic cassette upwards and by moving the bottom rail upwards. Aero is available as a complete kit and as a la carte pieces so you can create a multitude of combinations, perfect for any retail or event environment. Lights can easily be placed anywhere on the cassette and a multitude of accessory options, such as iPad and literature holders add more functionality.

lights can be placed anywhere on the cassette



11 GRAPHIC HEIGHT OPTIONS AVAILABLE

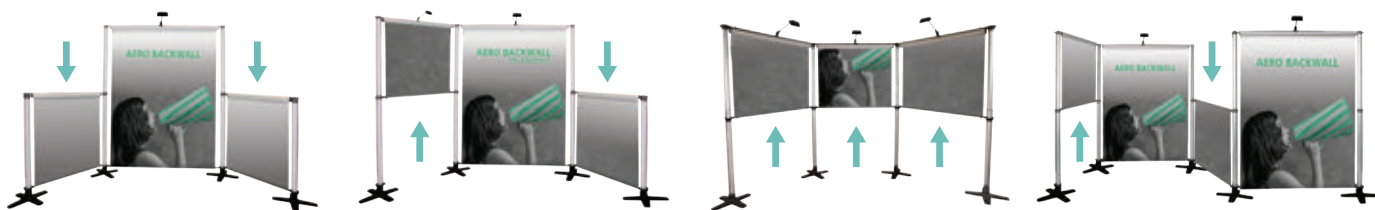

configure height by moving top cassette downwards

configure height by moving bottom rail upwards

AERO BASIC KIT

AERO2-1200-BASIC

- comes with 3 cassettes and 4 uprights with bases

AERO COMPLETE KIT

AERO2-1200-KIT

- comes with 3 cassettes, 4 uprights with bases, 3 LUM-200-ORL lights and rolling carry bag

AERO

- indoor modular display system
- standard graphic width = 47"
- graphics pull down from cassette
- 11 graphic height options
- available as a kit and "à la carte" to create more combinations

complete kit comes as shown



includes three LUM-200-ORL lights

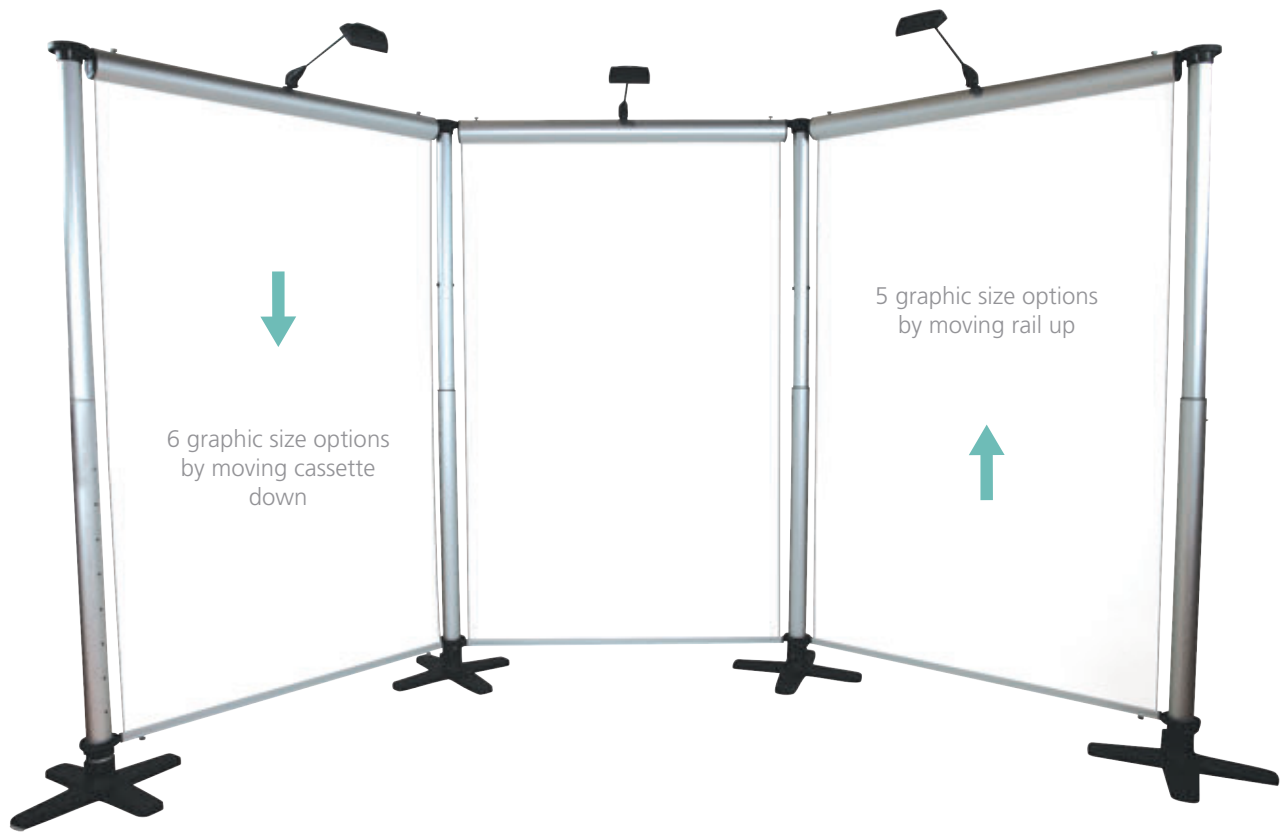

CLAMP
UC-AERO



TABLET HOLDER
UC-VESA-BRKT



LIT HOLDER BRACKET
UC-LIT-BRKT-ABH-02
UC-LIT-BRKT-ABH-03



SHELF BRACKET
UC-SHLF-BRKT-01-CIR
UC-SHLF-BRKT-02-TRI
UC-SHLF-BRKT-03-SQU

AERO UNIVERSAL ACCESSORIES

The new Universal Accessory system is designed to give you the freedom to add and change your accessories whenever you need to. Using the clamp that fits to the post, attach either a literature holder, a shelf or a TV/tablet bracket.

FREESTANDING iPad STANDS

Freestanding tablet stands are smart, lightweight and portable holders used to display tablets or iPads. They can be positioned in either portrait or landscape configurations. Security screws, allen key and bolts make the unit both durable and theft resistant. For extra security, the bases can also be bolted to the floor.

iPAD STAND

PAD12-02A-BLACK
PAD12-02A-SILVER
PAD12-02A-WHITE

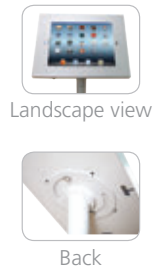

- displays iPad 2nd, 3rd, 4th gen and Air models*
- portrait or landscape
- security screws, allen key and bolts make the unit both durable and theft resistant
- base can be bolted to the floor for extra security
- offered in white, black and silver
- carry bag available as upgrade



UNIVERSAL TABLET STAND

NEW

PAD21-04

- displays multiple tablet styles or iPad*
- portrait or landscape
- security screws, allen key and bolts make the unit both durable and theft resistant
- base can be bolted to the floor for extra security
- features a telescopic, adjustable-height pole, height minimum 28.88" - maximum 49.81" h

TENSION FABRIC iPad STANDS

Are you looking to incorporate iPads into your display or environment? Sleekly-designed free standing iPad stands and kiosks make it easy to encourage interactivity, present information and engage your customers in any space. Stands feature stretch fabric graphics.

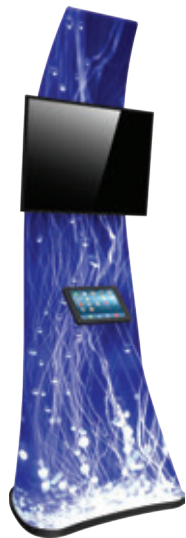

iPAD STAND 01
TABLET-STD-01



- 30" w x 84" h x 23" d
- small monitor mount*, holds 32" TV/32 lbs max
- iPad holder (2nd, 3rd, 4th gen and Air models)*
- pillowcase fabric graphic



iPAD STAND 02
TABLET-STD-02



- 20.25" w x 85.11" h x 23.8" d
- iPad holder (2nd, 3rd, 4th gen and Air models)*
- pillowcase fabric graphic



iPAD STAND 03
TABLET-STD-03



- 19.98" w x 64.34" h x 15.2" d
- iPad holder (2nd, 3rd, 4th gen and Air models)*
- pillowcase fabric graphic



iPAD STAND 04
TABLET-STD-04



- 26.26" w x 46.26" h x 22.64" d
- iPad holder (2nd, 3rd, 4th gen and Air models)*
- pillowcase fabric graphic

*Monitor and tablet not included.





CHARGING STATIONS

Formulate™ Charging Stations add technology and great value for visitors in need of a quick charge. Excellent for retail applications, trade shows, and events.



Charging station counters and bases are available in your choice of four thermoform finishes

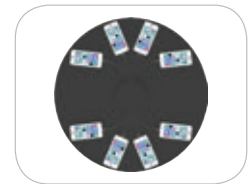
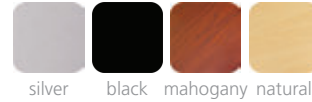

Top View

CHARGING TOWER
FMLT-CHRG-01

- 33.56" w x 86.81" h x 33.46" d
- features a circular fabric header for branding and an illuminated fabric center structure
- base and tabletop offered in choice of four laminate color options
- charges virtually all Android, iPod, iPhone, iPad, Micro-USB smartphones, tablets, and devices
- features 16 high-speed charging tips: (8) Micro USB for Android devices and (8) Apple 8-pin for Apple iPhone/iPad/Lightning devices

CHARGING COUNTER
FMLT-CHRG-COUNTER-01

- 23.72" w x 41.54" h x 23.62" d
- features stretch fabric graphic
- tabletop offered in choice of four laminate color options
- charges virtually all Android, iPod, iPhone, iPad, Micro-USB smartphones, tablets, and devices
- features 8 high-speed charging tips: (4) Micro USB for Android devices and (4) Apple 8-pin for Apple iPhone/iPad/Lightning devices



FORMULATE™ COUNTERS

Formulate™ counters couple lightweight hardware with state-of-the-art printed stretch silicone edge fabric graphics (SEG) to create funky and functional reception stands.



PILLAR
W-01-C 



HALF MOON
W-02-C



ELLIPSE
W-03-C 



BULLET
W-04-C



OVAL
W-05-C 



BAR
W-06-C 

tension fabric counter tops are available in your choice of finishes



silver black mahogany natural



LIFE TIME

SYMPHONY™ COUNTERS

Symphony™ counters provide a unique, sleek design that lends an attractive element to any trade show or POP display. Symphony counters combine extrusion-based hardware with state-of-the-art PRINTED or SOLID COLOR stretch fabric silicone edge fabric graphics (SEG).



OVAL
SYM-OV



RECTANGLE
SYM-RCT



BULLET
SYM-BLLT



OVAL DOUBLE GRAND
SYM-OV-DBL-GRND



3 QUAD KIT
SYM-QD-3

tension fabric counter tops are available in your choice of finishes



silver black mahogany natural

counter stretch skirts are available in custom printed options as well as the following colors:



amethyst ruby sapphire emerald silver jet

accents & accessories | COUNTERS

VECTOR FRAME™ COUNTERS

Vector Frame™ Counters complement the Vector Frame series of exhibit kits, but are also ideal for any stand-alone event or display. Vector Frame counters couple simple extrusion-based frames with push-fit fabric graphics or rigid sintra graphics. Tables are available in four colored finishes – silver, black, mahogany and natural. Counters fit in an OCH2 portable shipping case and allow for accessible storage by removing one fabric panel. Custom sizes also available.

Vector Frame counter tops are available in your choice of four thermoform colors



Vector Frame Counter 01
39.37" w x 36.62" h x 22.5" d
VFC-01



Vector Frame Counter 02
55.5" w x 40.5" h x 22.7" d
VFC-02



Vector Frame Counter 03
38.5" w x 40.5" h x 19.88" d
VFC-03



Vector Frame Counter 04
30.62" w x 40.5" h x 18.75" d
VFC-04



Vector Frame Counter 05
39.75" w x 40.5" h x 22.75" d
- features locking door and rigid sintra graphics
VFC-05



Vector Frame Counter 06
41.62" w x 40.5" h x 20.75" d
- features locking door and rigid sintra graphics
VFC-06



Vector Frame Counter 07
46" w x 40.5" h x 22.62" d
VFC-07



Select Hybrid Pro counter tops are available in your choice of four laminate colors



All Hybrid Pro Modular counters are also available for rent

HYBRID PRO™ COUNTERS

All Hybrid Pro™ Modular counters feature accessible storage and locking doors. Printed fabric graphics or rigid infill panels allow for your messaging and branding. Choose the size and counter shape that will match your backwall and space best.



Hybrid Pro Counter 01
39.38" w x 39.38" h x 17.75" d
HPC-01
- white laminate cabinet with fabric graphic on the front, opaque or backlit



Hybrid Pro Counter 02
70.88" w x 39.38" h x 23.63" d
HPC-02
- white laminate cabinet with fabric graphic on the front, opaque or backlit



Hybrid Pro Counter 03
39.38" w x 36.63" h x 15.75" d
HPC-03
- white laminate panel cabinet with UV graphic on the front and laminate top



Hybrid Pro Counter 04
74.75" w x 36.5" h x 25.38" d
HPC-04
- white laminate panel cabinet with UV graphic on the front and laminate top



Hybrid Pro Counter 09
46" w x 37.5" h x 19.38" d
REC-42
- white laminate cabinet with UV graphic on the front, opaque or backlit



Hybrid Pro Counter 10
64" w x 37.5" h x 30" d
REC-52
- white laminate cabinet with UV graphic on the front, opaque or backlit



Hybrid Pro Counter 11
71.06" w x 36.61" h x 32.72" d
RCK-06
- white laminate panel cabinet with UV graphic on the front and laminate top



accents & accessories | COUNTERS

LINEAR™ BOLD COUNTERS

Dress up your space with sophisticated and functional counters. Counter tops are available in four thermoform finishes – silver, black, mahogany and natural. Printed graphic panels create the base of the counter. Counters come standard with locking cabinet door.

Linear counter tops are available in your choice of four thermoform finishes



LN-CU-01



LN-CU-02



LN-CU-03



LN-CU-05

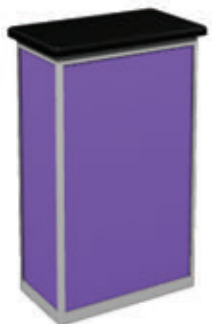

LN-CU-06



LN-CU-07



LN-CU-08

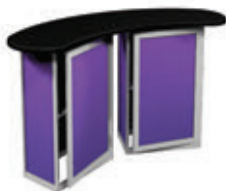

LINEAR™ COUNTER LN-TBL-SA-RCT

- 3 graphic panels to display custom graphics
- quick & easy-to-assemble, tool included
- fits in an OCH shipping and transport case
- aluminum design is sturdy and stable
- open back; optional locking door available
- top available in four laminate finishes





FORMULATE™ KIOSKS

Formulate™ Kiosks couple lightweight aluminum tube frames with state-of-the-art printed stretch zipper pillowcase fabric graphics to create funky and functional multimedia kiosks.



KIOSK 1
FMLT-KIOSK-01

- 29.53" w x 98.53" h x 31.78" d
- pillowcase fabric graphic
- supports medium monitor*

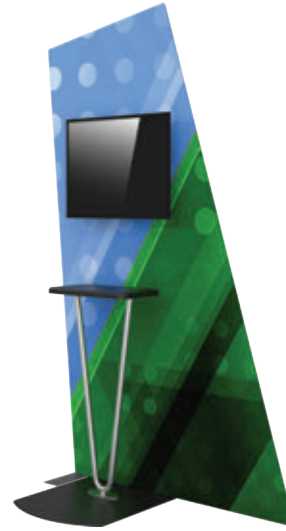

KIOSK 2
FMLT-KIOSK-02

- 61.72" w x 98.16" h x 34.57" d
- pillowcase fabric graphic
- supports medium monitor*



KIOSK 3
FMLT-KIOSK-03

- 55.12" w x 98.61" h x 36.03" d
- pillowcase fabric graphic
- supports medium monitor*



KIOSK 4
FMLT-KIOSK-04

- 39.37" w x 92.52" h x 35.75" d
- pillowcase fabric graphic
- supports medium monitor*

*Monitor not included.



VECTOR FRAME MONITOR KIOSKS

Vector Frame™ Monitor Kiosks are a sleek, stylish way to display media at any tradeshow, event, in a retail or corporate space. The kiosks feature push-fit fabric graphics, easy-to-assemble 4" extrusion frames, your choice of single or double sided graphics and one or two monitor mounts (monitors not included). These kiosks complement the Vector Frame line of banners, backwalls, exhibit kits and counters.



01 Monitor Kiosk
VF-MK-01-SS
VF-MK-01-DS
 36.3" w x 94.74" h x 19.69" d
 comes in 1 OCH case
 supports 26-40" monitor*;
 max weight = 25 lbs each



back with graphic



back with graphic & monitor mount*



top view
one monitor mount

front with graphic & monitor mount*



02 Monitor Kiosk
VF-MK-02-SS
VF-MK-02-DS
 48.11" w x 94.74" h x 19.69" d
 comes in 1 OCH case
 supports 26-40" monitor*;
 max weight = 25 lbs each



back with graphic



back with graphic & monitor mount*



top view
two monitor mounts

front with graphic & monitor mount*



LINEAR KIOSK 01
LN-K-01

- 54.4" w x 99" h x 23.25" d
- monitor* mount
- fabric canopy
- approximate weight: 125 lbs



LINEAR KIOSK 05
LN-K-05

- 25.38" w x 72.25" h x 18.5" d
- monitor* mount
- approximate weight: 30 lbs



MONITOR KIOSK
FREESTANDING-SPLIT-MM-KIT

- large monitor* bracket
- max weight = 80 lbs
- OCFM case optional
- monitor not included*

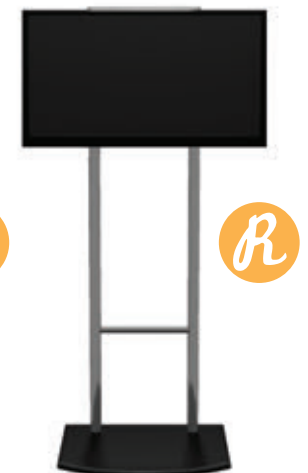

MONITOR KIOSK
VB-MK-01

- medium monitor* bracket
- max weight = 50 lbs
- comes with 1 OCH2 case
- monitor not included*



*Monitors not included.

LITERATURE RACKS | accents & accessories



ZEDUP 1

black: ZD-1-B
silver: ZD-1-S

- 6 pocket rack
- can be stored or shipped loaded with literature



hard case upgrade:
black: ZD-1HC-B
silver: ZD-1HC-S



ILLUSION

black: IL-1-B
silver: IL-1-S

- fast-folding cantilever rack
- 4 front facing pockets



ZEDUP LITE

silver: ZD-LITE

- 6 pocket rack
- collapsible
- lightweight version of the ZedUp
- constructed from aluminum & plastic for reduced weight



DEMONSTRATOR

DEMONSTRATOR

- 45" h
- stylish acrylic sign holder holds literature in top and bottom pockets
- top frame can be used in landscape configuration only
- acrylic sign holders, brushed silver post and base



INNOVATE

black: INN-B
silver: INN-S

- modular design
- 10 pockets
- packs in 3 separate parts for reduced shipping size



VICTORY

VIC-S

- slim, modular, snap-together design



10 UP

black: 10UP-B

- strong & stable
- 10 pockets
- packs flat

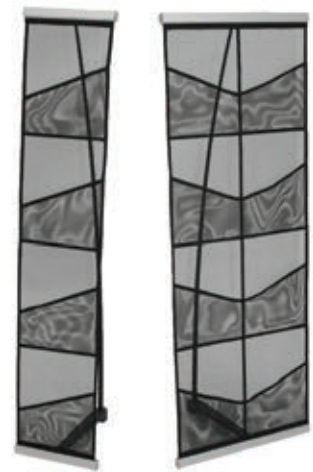

LR 1 & LR 2

4 pocket: LR-1
8 pocket: LR-2

- modular, roll-up mesh design
- holds standard 8.5" w x 11" h literature
- 4 or 8 pocket model
- black with chrome accent



All literature racks come with a five year limited warranty, a carry bag, and are an eco-friendly choice.

SLIM LINE LED LIGHTING

Lighting can create a powerful, impactful presence or display. Illumination is an important piece of the puzzle to achieve the mood, style and staging that you desire. A variety of Luminosity™ display lights, lighting kits and solutions are available to help clients make their projects and products shine!



LED FLOOD LUM-LED4-ORL-B

- low voltage 12 watt spotlight
- 17.16" long from end to end
- mounts to dovetails and extrusion channel
- available in black only

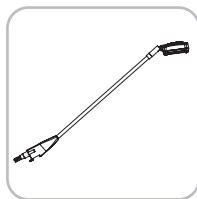

LED SPOT LUM-LED3-ORL-B

- low voltage 5 watt slender spotlight
- 17.18" long from end to end
- mounts to banner stands
- available in black only

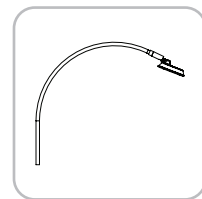

LED STRIP LUM-LED5-ORL-B

- low voltage 12 watt
- 16.1" long from end to end
- mounts to dovetails and extrusion channel
- available in black only

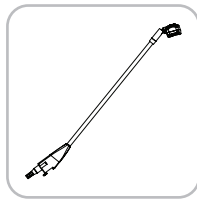

LED EXHIBITION LUM-LED6-ORL-B

- low voltage 12 watt spotlight
- 17.13" long from end to end
- mounts to extrusion channels
- available in black only

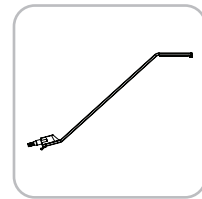

LUMINA 200 LED

Black: LUM-LED2-ORL-B
Silver: LUM-LED2-ORL-S

- LED Lumina 200 floodlight
- Uses multi cups chip on board (MCOB) light technology and features a slim profile
- LED rated for 20,000 continuous hours
- 19" long from end to end

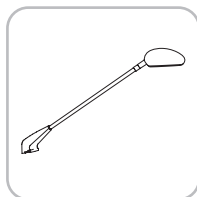

LIGHTING IS AN IMPORTANT ELEMENT TO ANY DISPLAY



LIGHTING DRAWS ATTENTION TO YOUR BRAND AND MESSAGE WITH ELEGANCE.



Lighting can create a powerful, impactful presence or display. Illumination is an important piece of the puzzle to achieve the mood, style and staging that you desire. A variety of Luminosity™ display lights, lighting kits and solutions to help clients make their projects shine!

LUMINOSITY DISPLAY LIGHTING



LUMINA 1

black: LUM-1-B
chrome: LUM-1-C

- low voltage 50 watt spotlight & universal fittings kit
- "goose neck" arm
- mounts horizontally
- LED option available

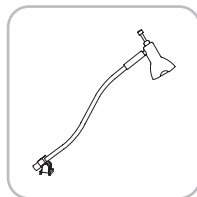

LUMINA 2

LUM-2-1

- low voltage 50 watt slender spotlight
- mounts to a vertical pole
- brushed stainless steel finish
- LED option available

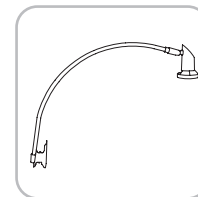

LUMINA 5

LUM-5

- low voltage 50 watt spotlight & universal fittings kit
- deluxe chrome head
- telescopic arm
- extends from 7" - 22" long
- LED option available

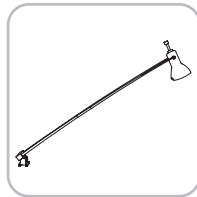

LUMINA 6

LUM-6

- low voltage, 50 watt spotlight & universal fittings kit
- stylish curved twin arms
- silk black only
- LED option available

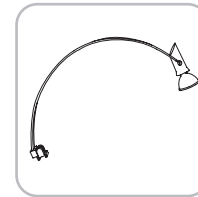

LUMINA 8

black: LUM-8-B
silver: LUM-8-C

- 12 volt spotlight with straight arm & adjustable head
- includes 110 volt UL approved transformer, 50 watt bulb & universal fittings kit
- 17" long from end to end
- LED option available

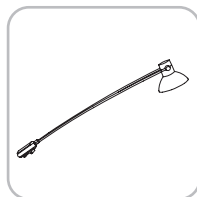

LUMINA 200 FLOODLIGHT

LUM-200-ORL

- 110 volt ETL approved wall washer floodlight with a straight arm & adjustable head
- light includes 120 watt halogen bulb
- 19.5" long from end to end
- silk black finish

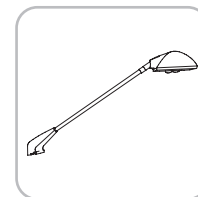

UNIVERSAL LIGHT CLAMP KIT

UNI-LT-CLP30
UNI-LT-CLP50

- comes standard with the Lumina 1, 5, 6, 8 and allows our lights to fit a majority of banners, truss & panel kits



SPT CASE

SPT-CASE

- EVA semi-rigid lighting case
- foam-lined padded compartments
- holds two Lumina lights & power supply



LED BULB OPTION

LUM-LV-LED-BLB16

- a green solution for Lumina 1, 2, 5, 6, 8
- 50 watt equivalent LED bulb



LUMINA SPARE BULB KIT

LUM-BULB

- (2) 50 watt low voltage spare bulbs in a padded, protective EVA formed case



FLOODLIGHTS & WALL WASHERS

LED FLOOD LIGHT

LED-FLOOD

- 85-265 voltage, 42 watt LED Flood light (equivalent to 400 watt halogen)
- projects cool WHITE light
- 7.4" w x 9.44" l x 5.11" d
- angles to 120°
- UL approved



MINI LED FLOOD LIGHT

LED-10W-FLOOD-RGB

LED-10W-FLOOD-W

- 10 watt LED Flood light
- projects cool WHITE or RGB spectrum light
- remote control provided with RGB version
- each light measures 4.49" w x 3.39" h x 3.98" d
- angles to 120°
- UL approved



COLOR BLAST ACCENT LIGHTS

- 85-265 voltage, 13 watt LED blast light
- projects your choice of warm or cool WHITE, and a RGB spectrum flashing pattern
- 7" round x 7" h (when faceplate is flush with base and not angled)
- angles to 60°
- UL approved



LED-WRM-WHT-BLAST
Features a warm white LED light output; good for light-colored and neutral graphic prints. 3,000K



LED-COOL-WHT-BLAST
Features a cool LED light output; good for darker graphic prints. 6,000K



LED-RGB-BLAST
Features multi-pattern flashing RGB LED light output; RGB spectrum cannot be controlled.



UNIVERSAL ACCESSORIES

The new Universal Accessory system is designed to give you the freedom to add and change your accessories whenever you need to. Using the clamp that fits to the post, attach either a literature holder, a shelf or a tablet bracket. There are different clamps designed to fit onto Aero, Formulate™ and Linear™ display systems.

AERO UNIVERSAL ACCESSORIES



CLAMP
UC-AERO



TABLET HOLDER
UC-VESA-BRKT



LIT HOLDER BRACKET
UC-LIT-BRKT-ABH-02
UC-LIT-BRKT-ABH-03



SHELF BRACKET
UC-SHLF-BRKT-01-CIR
UC-SHLF-BRKT-02-TRI
UC-SHLF-BRKT-03-SQU

FORMULATE UNIVERSAL ACCESSORIES



CLAMP
UC-FMLT



TABLET HOLDER
UC-VESA-BRKT



LIT HOLDER BRACKET
UC-LIT-BRKT-ABH-02
UC-LIT-BRKT-ABH-03



SHELF BRACKET
UC-SHLF-BRKT-01-CIR
UC-SHLF-BRKT-02-TRI
UC-SHLF-BRKT-03-SQU

LINEAR UNIVERSAL ACCESSORIES



CLAMP
UC-EXT



TABLET HOLDER
UC-VESA-BRKT



LIT HOLDER BRACKET
UC-LIT-BRKT-ABH-02
UC-LIT-BRKT-ABH-03



SHELF BRACKET
UC-SHLF-BRKT-01-CIR
UC-SHLF-BRKT-02-TRI
UC-SHLF-BRKT-03-SQU

CASES & CRATES

It's critical to protect your tradeshow exhibit investment with a quality constructed transit and shipping case. An extensive selection of exhibit and display cases and crates to choose from that are all made in the USA and are designed to house specific lines of exhibits and displays for maximum portability and protection during shipping.

LIGHTING & ACCESSORY CASE

OCA-2

- ideal for lights and accessories
- secure straps help to ensure case will remain closed during transport
- interior size:
32.81" w x 4.13" h x 13.75" d
- exterior size:
34" w x 7" h x 15" d
- weight when empty: 8 lbs



SMALL & LARGE GRAPHIC CASES

small: OCS large: OCL

- premium latches for maximum strength
- built in wheels and easy-to-grip molded handle

OCS

- interior size:
14" w x 39.81" h x 13.25" d
- exterior size:
18" w x 42.25" h x 16.5" d
- weight when empty: 18 lbs

OCL

- interior size:
14" w x 51.5" h x 13.25" d
- exterior size:
18" w x 55.13" h x 16.5" d
- weight when empty: 20 lbs



BANNER STAND CASE

OCB

- this expandable shipping case fits up to three swivel-foot banner stands with bags or one premium stand with bag*
- also used for Formulate™ Lite displays
- interior size min/max:
min - 12" w x 30.13" h x 3.75" d
max - 12" w x 47.13" h x 3.75" d
- exterior size:
min - 14.56" w x 30.38" h x 5.88" d
max - 14.56" w x 47.38" h x 5.88" d
- weight when empty: 9 lbs
- *case does not fit Uno, Spring 5, Contender 48 or banners over 39.37" wide



EXPANDABLE CASE

OCE

- the perfect protective shipping and/or storage case for all Formulate™ exhibit kits, hanging structures and accessory products
- adjustable roto-molded expandable display case
- adjustable lid and easy pin latch
- interior size min/max:
min - 13.75" w x 39.63" h x 11.75" d
max - 13.75" w x 64" h x 11.75" d
- exterior size min/max:
min - 16.75" w x 39.88" h x 16.88" d
max - 16.75" w x 64.25" h x 16.88" d
- weight when empty: 27 lbs
- separate fabric graphic converts the case into a counter



All cases come with a one year limited warranty, are an economic & eco-friendly choice & made in the USA.

STANDARD WHEELED DISPLAY CASE OCX



- light storage in the lid
- premium latches for maximum strength
- interior size:
23.5" w x 35.75" h x 13.07" d
- exterior size:
26.73" w x 39.49" h x 17.05" d
- weight when empty: 31 lbs



PREMIUM WHEELED DISPLAY CASE OCP-2

- premium latches for maximum strength
- hinged lid with internal light storage
- robust, roto-molded plastic
- interior size:
22" w x 35.5" h x 14.13" d
- exterior size:
26" w x 39.56" h x 17.75" d
- approximate weight when empty: 32 lbs



DELUXE WHEELED DISPLAY CASE OCP-ELITE

- lid can be used as a step stool while assembling displays
- access door provides storage when unit is used as a counter
- interior size:
14.13" w x 31.75" h x 19.75" d
- exterior size:
16.75" w x 38.25" h x 26.25" d
- weight when empty: 31 lbs



HOPUP/MEDIUM WHEELED CASE OC-HOP

- ideal for Hopup backwall displays (fits up to 4x3 hopup)
- built-in handle and wheels for easy transport
- interior size:
13.5" w x 35.5" h x 13.5" d
- exterior size:
15.5" w x 35.69" h x 17" d
- weight when empty: 17 lbs



LARGE DISPLAY CASE OCH

- roto-molded case for exhibits, graphics & accessories
- secure reinforced straps help to ensure case will remain closed during transport
- strong yet lightweight
- interior size:
23.25" w x 7.63" h x 46.5" d
- exterior size:
26" w x 12" h x 50" d
- weight when empty: 22 lbs



LARGE DISPLAY CASE OCH2

- heavy-duty shipping and storage case
- ideal for Linear hybrid displays
- secure reinforced straps help to ensure case will remain closed during transport
- interior size:
24.13" w x 12.25" h x 47.25" d
- exterior size:
29" w x 15" h x 52" d
- weight when empty: 30 lbs
- wheels and handles recessed



All cases come with a one year limited warranty, are an economic & eco-friendly choice & made in the USA.

FREIGHT CASE

OCHM

- interlocking surface to enable two cases to be transported together
- maximum case depth = 8" allowing up to 8 flat panels per case
- interior size: 23.75" w x 9.75" h x 36.63" d
- exterior size: 26" w x 14" h x 38" d
- weight when empty: 20 lbs



FREIGHT CASE

OCFM

- interlocking surface to enable two cases to be transported together
- maximum case depth= 8" allowing up to 8 flat panels per case
- interior size: 35.75" w x 9.75" h x 47.25" d
- exterior size: 38" w x 15" h x 49" d
- weight when empty: 35 lbs



FREIGHT CASE

OCF

- offers the same features and benefits of the OCT in a rectangular shape
- interior size: 48" w x 19.75" h x 35.5" d
- exterior size: 51" w x 24" h x 39" d
- weight when empty: 55 lbs



FREIGHT CASE

OCF2

- molded stackable shipping crate 18" deep
- heavy-duty roller bearing recessed in bridge of case
- holds 18 layers of flat panels in horizontal direction
- interior size: 48" w x 18" h x 48" d
- exterior size: 51" w x 23" h x 51" d
- weight when empty: 70 lbs



LCD MONITOR CASE

OCM

- black LDPE case designed for LCD monitors
- built in dry erase board to label contents and location
- fits 37 - 47" screens
- includes 3" casters with rubber wheels
- must be shipped freight
- interior size: 45.5" w x 30" h x 5" d
- exterior size: 54" w x 35" h x 16" d
- weight when empty: 97 lbs



ORBITAL CURVED TRUSS CASE

OCT

- designed to handle national & international exhibit freight shipments
- offers maximum protection for your exhibit materials
- interior size: 43.5" w x 33" h x 47.25" d
- exterior size: 48" w x 42" h x 51" d
- weight when empty: 138 lbs



All cases come with a one year limited warranty, are an economic & eco-friendly choice & made in the USA.

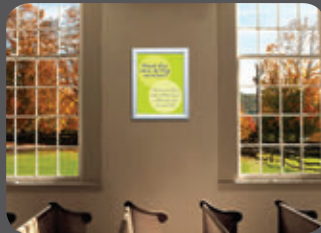
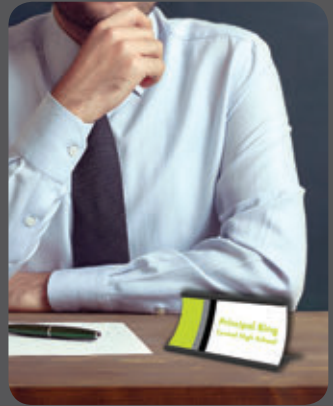
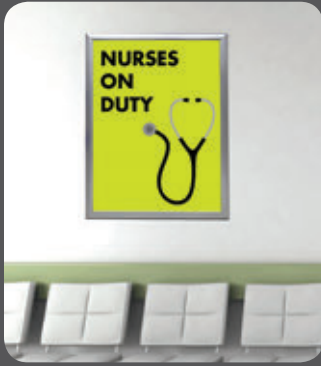

Wayfinding 101: Directional Signage Solutions

THE SIGN MAKERS™
HANDBOOK
WAYFINDING SYSTEMS

www.signmakers-handbook.com

A

ACCENTS & ACCESSORIES	66, 216
ACCLAIM SIGN STAND	71
ACCOLADE SIGN STAND	71
ADVANCE BANNER STAND	4
ADVOCATE SIGN STAND	71
AERO BANNER SYSTEM	23, 214
AMBASSADOR NAME TAG	75
APEX A-FRAME OUTDOOR SIGN	75
ARCHES	150
ATLAS OUTDOOR SIGN	30

B

BACKLIT HOPUP	39
BACKLIT COYOTE POPUP TOWER	72
BANNER DISPLAYS	16, 88
BANNER STANDS	2
BANNER STAND ACCESSORIES	5
BANNER SYSTEMS	22
BARRACUDA BANNER STAND	4
BLADE LITE BANNER STAND	3
BLADE LX BANNER STAND	7
BLIZZARD OUTDOOR SIGN	32
BLOK BANNER STAND	7
BREEZE	11
BUBBLE PANEL FOR COYOTE POPUP	59
BULLET HANGING STRUCTURE	143

C

CAFÉ BARRIER	22, 30
CAMPAIGN COUNTER	70
CAPSULE ILLUMINATED HANGING STRUCTURE	143
CASES	79, 230
CASE TO COUNTERS	60
CHARGING COUNTER	68, 134, 217
CHARGING TOWER	68, 134, 217
COBRA FABRIC BANNER	17, 89
COLOR BLAST ACCENT LIGHTS	78, 228
COLUMNS	148
CONE HANGING STRUCTURE	141
CONFERENCE WALLS	152
CONCAVE SQUARE HANGING STRUCTURE	139
CONTENDER BANNER STAND	6
CONVERTIBLE TABLE THROW	35
CONVEX TRIANGLE (SHIELD) HANGING STRUCTURE	139
COUNTERS	69, 132-133, 166-167, 181-182, 184-185, 218-222
COYOTE	56
COYOTE MINI	59
COYOTE POPUP DISPLAY SYSTEMS	58
COYOTE TOWER	59
CRESCENT BANNER STAND	7
CUBE HANGING STRUCTURE	142
CUBE TOWER / PRISM TOWER	72
CURVE HANGING STRUCTURE	141
CURVED HOPUP CONFIGURATIONS	41
CURVED BANNERS	20, 172
CYLINDER TOWER	147

D

DEMONSTRATOR SIGN STAND	73
DESIGNER SERIES HANGING STRUCTURES	144
DISC HANGING STRUCTURE	141
DRAGON FLY BANNER STAND	8

E

ECONOMY RETRACTABLE BANNER STANDS	8
ECONOMY SPRING BACK BANNER STANDS	14
EDGE POSTER FRAMES	173
ELEVATE BANNER STAND	7
ELLIPSE FABRIC COUNTER	132, 218
EMBRACE PUSH-FIT FABRIC DISPLAYS	44
EMBRACE COUNTER	46, 70
ENTICE FABRIC BANNER	17, 89
ESSENTIAL HANGING STRUCTURES	136
EXCALIBUR BANNER STAND	4
EXPOSÉ TELESCOPIC DISPLAY	12
EYE HANGING STRUCTURE	143

F

FITTED TABLE THROW	36
FLIP 20' EXHIBIT KITS	120
FOLDING DISPLAY PANELS	62
FOOTBALL HANGING STRUCTURE	140
FORMULATE COUNTERS	132, 218
FORMULATE DESIGNER SERIES	110
FORMULATE DESIGNER SERIES 10' DISPLAY	110
FORMULATE DESIGNER SERIES 20' DISPLAYS	114
FORMULATE DESIGNER SERIES 30' DISPLAYS	118
FORMULATE ESSENTIAL BANNER- STRAIGHT	16, 88
FORMULATE ESSENTIAL BANNER- CURVED	16, 88
FORMULATE FABRIC BANNER	17, 89
FORMULATE FUSION KIT 02	17, 124
FORMULATE FUSION KIT 05	125
FORMULATE FUSION KIT 06	126
FORMULATE FUSION KIT 07	127
FORMULATE FUSION KIT 08	128
FORMULATE FUSION KIT 09	129
FORMULATE FUSION KIT 10	130
FORMULATE FUSION KIT 11	131
FORMULATE LITE	92
FORMULATE MASTER	93
FOUR-SIDED PINWHEEL HANGING STRUCTURE	142
FOUR-SIDED PYRAMID HANGING STRUCTURE	140
FREEDOM BANNER STAND	8
FREESTANDING TABLET STANDS	67, 216
FUNNELS	146

G

GIANT MOSQUITO	9
----------------	---

H

HALF MOON FABRIC COUNTER	69, 132, 218
HANGING STRUCTURES	136
HERO DISPLAY PANELS	63
HEXAGON HANGING STRUCTURE	142
HOPUP ACCESSORY KITS	43
HOPUP BACKWALL DIMENSION KITS	42
HOPUP BACKWALLS	38
HOPUP COUNTER	40, 70
HOPUP TENSION FABRIC	38
HORIZON FOLDING PANELS	63
HYBRID PRO MODULAR EXHIBIT KITS	156

I		
ILLUSION LITERATURE RACKS	73, 225	
IMAGINE BANNER STAND	4	
IMPRINTED TABLE THROW	37	
INFLATABLE COLUMNS	31	
INFLATABLE 10' DOME TENT	27	
INNOVATE LITERATURE RACKS	73, 225	
INTERNAL SHELF KIT	59	
IPAD STAND	67, 134, 216	
K		
KIOSKS 1-4	135, 223	
KIOSKS	68, 134, 135, 185, 223, 224	
L		
L-MINI BANNER STAND	14	
LED BULB OPTION	78, 228	
LED EXHIBITION	76, 226	
LED FLOOD LIGHT	76, 226	
LED FLOOR FLOOD LIGHT	78, 228	
LED SPOT LIGHT	76, 226	
LED STRIP LIGHT	76, 226	
LIGHTNING BANNER STAND	14	
LINEAR PRO	182	
LITERATURE RACKS	73, 225	
LR1 & LR2 LITERATURE RACKS	73, 225	
LUMINA SPARE BULB KIT	78, 228	
LUMINA 1, 2, 5, 6, 8 DISPLAY LIGHTING	77, 227	
LUMINA 200 FLOODLIGHT	77, 227	
LUMINA 200 LED FLOODLIGHT	76, 226	
LUMINOSITY DISPLAY LIGHTING	76, 226	
M		
MERCHANDISE EXPRESS KITS	186	
MERLIN BANNER STAND	11	
MINI LED FLOOD LIGHT	78	
MONITOR KIOSKS	70	
MONITOR MOUNT	59	
MONSOON OUTDOOR SIGN	32	
MOSQUITO BANNER STAND	9	
MOSQUITO LITE BANNER STAND	9	
O		
OASIS BAG HOLDER	75	
OBSERVE DELUXE SIGN STAND	71	
OBSERVE GRAND SIGN STAND	71	
OBSERVE PRO SIGN STAND	71	
OC-HOP DISPLAY CASE	80, 231	
OCA-2 DISPLAY CASE	79, 230	
OCB DISPLAY CASE	79, 230	
OCE DISPLAY CASE	79, 230	
OCH DISPLAY CASE	80, 231	
OCH2 DISPLAY CASE	80, 231	
OCL DISPLAY CASE	79, 230	
OCP CASES	60	
OCP ELITE DISPLAY CASE	80, 231	
OCP-2 DISPLAY CASE	80, 231	
OCS DISPLAY CASE	79, 230	
OCX DISPLAY CASE	80, 231	
ORIENT 1 BANNER STAND	6	
ORIENT 2 BANNER STAND	6	
OUTDOOR DISPLAYS	24	
OUTDOOR SIGNAGE	30	
OVAL FABRIC COUNTER	69, 132, 218	
OVAL DOUBLE GRAND SYMPHONY COUNTER	69, 133, 219	
P		
PACIFIC BANNER STAND	6	
PANEL HANGING STRUCTURE	141	
PARKWAY OUTDOOR POLE BANNERS	31	
PEGASUS LINKING KIT	13	
PEGASUS STANDARD	13	
PEGASUS SUPREME	13	
PHOENIX BANNER STAND	11	
PHOENIX MINI BANNER STAND	11	
PILLAR FABRIC COUNTER	132, 218	
PINWHEEL HANGING STRUCTURE	140	
POSTER FRAMES	21	
POSTER SNAPPER	74	
PRINTED TABLE THROW	35	
PROMOTIONAL UMBRELLAS	33	
Q		
QUICKSAND BANNER DISPLAY	10	
QUICKWALL BANNER DISPLAY	10	
R		
RECTANGLE HANGING STRUCTURE	140	
RING HANGING STRUCTURE	138	
ROUNDED FUNNEL	141	
ROUNDED SQUARE HANGING STRUCTURE	142	
ROUND TABLE THROWS	36	
RUNNERS	35	
S		
S-CURVE HANGING STRUCTURE	141	
SHARK FIN FABRIC BANNER	17, 89	
SIGN STANDS	71	
SNAPPER STAND	71	
SOLO BANNER STAND	8	
SPARTAN SIGN STAND	71	
SPRING 1-1 BANNER STAND	14	
SPRING 1-2 BANNER STAND	14	
SPRING 1-3 BANNER STAND	14	
SPRING 3 BANNER STAND	15	
SPRING 4 BANNER STAND	15	
SPRING 5 BANNER STAND	32	
SPRING 6 BANNER STAND	15	
SPRING 7 BANNER STAND	15	
SPT LIGHT CASE	78, 228	
SQUARE HANGING STRUCTURE	138	
SQUARE FUNNEL TOWER	141	
SQUARE MOBILE HANGING STRUCTURE	144	
STANDARD RETRACTABLE BANNER STANDS	6	
STANDARD TELESCOPIC BANNER STANDS	13	
START BANNER STAND	8	
STEP STOOL	75	
STOWAWAY OUTDOOR SIGN	33	
STRAIGHT HOPUP CONFIGURATIONS	40	
STRETCH TABLE THROW	36	
SYMPHONY COUNTERS	69, 133, 219	

T

TABLE RUNNERS	35
TABLE THROWS	34
TABLETOP DISPLAYS	90
TABLETOPS VECTOR FRAME	180
TAPERED RING HANGING STRUCTURE	138
TAPERED SQUARE HANGING STRUCTURE	138
TAPERED TRIANGLE HANGING STRUCTURE	139
TENSION FABRIC COUNTERS	69, 132
TENSION FABRIC IPAD STANDS	67, 134, 218
THREE-SIDED PYRAMID HANGING STRUCTURE	141
THUNDER BANNER STAND	32
TIERED BULLET HANGING STRUCTURE	143
TIERED RING HANGING STRUCTURE	145
TIERED RING FLAT HANGING STRUCTURE	145
TIERED SQUARE HANGING STRUCTURE	144
TOWERS	72, 147
TRAPPA LIGHTBOX	74
TRAPPA POST	72
TRAPPA POSTER FRAME	74
TRI-TOWER DELUXE	72
TRIANGLE HANGING STRUCTURE	139
TRIO BANNER STAND	13
TRIO LITERATURE POCKET	13
TRUSS EXHIBITS & ACCESSORIES	190
TUBULAR 10' DOME TENT	27

U

UNIVERSAL ACCESSORIES	23, 93, 215, 229
UNIVERSAL LIGHT CLAMP KIT	78, 228
UNIVERSAL TABLET STAND	67, 216

V

VECTOR FRAME BANNERS	18, 170
VECTOR FRAME EDGE	21, 173
VECTOR FRAME LIGHT BOXES	19, 173
VECTOR FRAME MODULAR DISPLAYS	168
VIBE 10' EXHIBIT KITS	122
VICTORY LITERATURE RACK	73, 225
VOYAGER FOLDING PANELS	64

W

WEDGE OUTDOOR SIGN HOLDER	75
WHIRLWIND	30
WIND DANCER OUTDOOR DISPLAYS	30
WIND DANCER LT OUTDOOR DISPLAYS	30
WIND DANCER MINI OUTDOOR DISPLAYS	30

X

XCLAIM FABRIC POPUPS	48
XCLAIM FULL HEIGHT	51
XCLAIM TABLETOP KITS	50

Z

ZEDUP1 LITERATURE RACKS	73, 225
ZEDUP LITE LITERATURE RACKS	73, 225
ZOOM BACKPACK FLAGS	31
ZOOM BASE OPTIONS	29
ZOOM FLAGS	28
ZOOM 10' POPUP TENT	26
ZOOM 20' POPUP TENT	26

#

3D OVAL ILLUMINATED	143
8' DISPLAYS	90
10UP LITERATURE RACK	73, 225
10' ESSENTIAL EXHIBIT KITS	91
10' DISPLAYS	91
10' HORIZONTAL CURVED DISPLAYS	96
10' MODULAR BACKWALLS	158
10' VERTICAL CURVED DISPLAYS	94
10' X 10' EXHIBIT KITS	194
10' X 10' HERCULES KITS	192
10' X 20' EXHIBIT KITS	198
20' FORMULATE MASTER EXHIBIT KITS	104
20' MODULAR BACKWALLS	160
20' SERPENTINE CURVED DISPLAYS	104
20' STRAIGHT DISPLAY	109
20' VERTICAL CURVED DISPLAYS	106
20'X 20' ISLAND EXHIBIT KITS	162